

ECOSA®
IMPORTADORA ECO S.A.



Catálogo Ferretería

www.ecosa.cl - eco@ecosa.cl - Fono: 32 2293300 - Casilla 100 - Valparaíso.

CEPILLO DE ALAMBRE ONDULADO
Acero latonado (anti-chispa)

Calibre: 0.26 mm

ESPECIFICACIONES:
Largo: 24 cm
Ancho: 2 cm
Cerdas: 3.2 cm



CODIGO	REF	MEDIDA/TIPO	UN.	PRECIO + IVA
17-01-010	11540	10"	Pza. 6	

CEPILLO DE ALAMBRE
Alambre de alta resistencia en acero al carbono

MEDIDAS:
Calibre: 0.35 mm
16 x 4 hileras



CODIGO	REF	MEDIDA/TIPO	UN.	PRECIO + IVA
17-01-011	11559	29 x 3 cm	Pza. 12	

ESCOBILLA DE ALAMBRE
Alambre de alta resistencia en acero al carbono



CODIGO	REF	MEDIDA/TIPO	UN.	PRECIO + IVA
17-01-012	11556	17 x 5 cm	Pza. 6	
17-01-014	11562	18 x 7 cm	Pza. 6	

CEPILLO DE ALAMBRE CON MANGO
Cerdas de acero al carbono

ESPECIFICACIONES
Cerdas expuestas: 2.6 cm
Alambres por pincel: 24



CODIGO	REF	MEDIDA/TIPO	UN.	PRECIO + IVA
17-01-013	12656	24 x 4 cm	Pza. 4	

PIE DE METRO DIGITAL
Acero inoxidable

Conexión de salida de datos

ESPECIFICACIONES:
Tolerancia: 0.002"/0.05 mm
Capacidad máx: 6"/150 mm
Capacidad mín: 0.005"/0.01 mm



CODIGO	REF	MEDIDA/TIPO	UN.	PRECIO + IVA
17-01-001	14388	6"	Pza. 2	

PIE DE METRO ESCOLAR
Acero inoxidable

ESPECIFICACIONES:
Tolerancia: 0.158" / 0.4 mm
Capacidad máx: 6" / 152 mm



CODIGO	REF	MEDIDA/TIPO	UN.	PRECIO + IVA
17-01-005	12656	6"	Pza. 6	

MINI ABRAZADERA REFORZADA **FIERO**
Acero inoxidable

• Ancho 5/16"



Venta mínima: 1 bolsa

CODIGO	REF	MEDIDA/TIPO	UN.	PRECIO + IVA
--------	-----	-------------	-----	--------------

Bolsa 10 Unidades

17-01-100	44230	3/8" a 5/8"	Bolsa 10	
17-01-102	44231	1/2" a 3/4"	Bolsa 10	

ABRAZADERA REFORZADA **FIERO**
Acero inoxidable

• Calidad automotriz
• Ancho: 1/2"



Venta mínima: 1 bolsa

CODIGO	REF	MEDIDA/TIPO	UN.	PRECIO + IVA
--------	-----	-------------	-----	--------------

Bolsa 10 Unidades

17-01-105	44232	3/8" a 5/8"	Bolsa 10	
17-01-107	44233	1/2" a 3/4"	Bolsa 10	
17-01-109	44234	5/8" a 7/8"	Bolsa 5	
17-01-111	44236	5/8" a 1.1/4"	Bolsa 5	
17-01-114	44237	3/4" a 1.1/2"	Bolsa 5	
17-01-115	44238	3/4" a 1.3/4"	Bolsa 5	
17-01-118	44239	1.1/4" a 2"	Bolsa 5	
17-01-119	44240	1.1/2" a 2.1/4"	Bolsa 5	

Bolsa 5 Unidades

17-01-120	44241	1.9/16" a 2.1/2"	Bolsa 4	
17-01-122	44242	1.13/16" a 2.3/4"	Bolsa 4	
17-01-124	44243	2.1/4" a 3"	Bolsa 4	
17-01-126	44244	2.5/8" a 3.1/4"	Bolsa 4	
17-01-128	44245	2.9/16" a 3.1/2"	Bolsa 4	
17-01-130	44246	3.13/16" a 3.3/4"	Bolsa 4	
17-01-132	44247	3.1/16" a 4"	Bolsa 4	

JUEGO DE LLAVES ALLEN
10 piezas

- Cromo vanadio
- En organizador plástico



MEDIDAS

1.5 mm
2 mm
2.5 mm
3 mm
4 mm
5 mm
5.5 mm
6 mm
8 mm
10 mm

CODIGO	REF	MEDIDA/TIPO	UN.	PRECIO + IVA
17-01-054	15536	-	Jgo. 6	

JUEGO DE LLAVES TORX
9 Piezas

- Cromo vanadio
- En organizador plástico



MEDIDAS:

T-10
T-15
T-20
T-25
T-27
T-30
T-40
T-50

CODIGO	REF	MEDIDA/TIPO	UN.	PRECIO + IVA
17-01-060	15554	-	Jgo. 6	

JGO. DE LLAVES ALLEN TIPO NAVAJA
8 Piezas

Fabricadas en acero cromo vanadio



MEDIDAS

1/16" - 1.5 mm
6/64" - 2 mm
3/32" - 2.5 mm
1/8" - 3 mm
5/32" - 4 mm
3/16" - 5 mm
1/4" - 6 mm
5/16" - 8 mm

CODIGO	REF	MEDIDA/TIPO	UN.	PRECIO + IVA
17-01-051	15556	Pulgadas	Jgo. 6	
17-01-052	15555	Milímetros	Jgo. 6	

JUEGO DE LLAVES ALLEN
13 piezas

- Cromo vanadio
- En organizador plástico



MEDIDAS

1.3 mm
1.5 mm
2 mm
2.5 mm
3 mm
3.5 mm
4 mm
4.5 mm
5 mm
5.5 mm
6 mm
8 mm
10 mm

CODIGO	REF	MEDIDA/TIPO	UN.	PRECIO + IVA
17-01-056	15542	-	Jgo. 6	

JUEGO DE LLAVES TORX LARGAS
7 Piezas

- Cromo vanadio
- En organizador plástico



MEDIDAS:

T-10
T-15
T-20
T-25
T-27
T-30
T-40

CODIGO	REF	MEDIDA/TIPO	UN.	PRECIO + IVA
17-01-062	15553	-	Jgo. 6	

JGO. DE LLAVES TORX TIPO NAVAJA
8 Piezas

Cromo vanadio



PRETUL®

MEDIDAS:

T-9
T-10
T-15
T-20
T-25
T-27
T-30
T-40

CODIGO	REF	MEDIDA/TIPO	UN.	PRECIO + IVA
17-01-065	21395	-	Jgo. 6	

JUEGO DE LLAVES ALLEN LARGAS
7 Piezas

- Cromo vanadio
- Punta de bola que facilita el torque en lugares de difícil acceso
- En organizador plástico



MEDIDAS

2.5 mm
3 mm
4 mm
5 mm
6 mm
8 mm
10 mm

CODIGO	REF	MEDIDA/TIPO	UN.	PRECIO + IVA
17-01-050	15548	-	Jgo. 6	

JUEGO DE LLAVES ALLEN
8 Piezas, tipo llavero

- Acero carbono



PRETUL®

MEDIDAS

1.5 mm
2 mm
2.5 mm
3 mm
4 mm
5 mm
5.5 mm
6 mm

CODIGO	REF	MEDIDA/TIPO	UN.	PRECIO + IVA
17-01-067	21851	-	Jgo. 12	

JGO. EXTRACTORES TIPO PATA D/GALLO

13 Piezas

ESPECIFICACIONES:
Apertura máxima: 95 mm
Alcance máximo: 35 mm
Cabeza de tornillo: 11/16"



CODIGO	REF	MEDIDA/TIPO	UN.	PRECIO + IVA
17-01-024	14510	-	Jgo. 4	

JUEGO DE EXTRACTORES VOLANTES

10 piezas

ESPECIFICACIONES:
Apertura máxima: 76 mm
Alcance máximo: 32 mm
Cabeza de tornillo: 5/8"



CODIGO	REF	MEDIDA/TIPO	UN.	PRECIO + IVA
17-01-022	14508	-	Jgo. 3	

EXTRACTOR DE RODAMIENTOS

Medida ajustable



CODIGO	REF	MEDIDA/TIPO	UN.	PRECIO + IVA
17-01-017	14516	25 a 62 mm	Pza. 4	

EXTRACTOR DE POLEAS

Quijadas ajustables y reversibles

Para extracciones interiores y exteriores



CODIGO	REF	MEDIDA/TIPO	UN.	PRECIO + IVA
17-01-027	14500	P3 - 82,5 mm	Pza. 4	
17-01-029	14503	P4 - 127,0 mm	Pza. 4	
17-01-031	14506	P6 - 152,4 mm	Pza. 2	
17-01-033	14509	P8 - 266,0 mm	Pza. 2	

JUEGO DE EXTRACTORES DE PERNOS

5 piezas



CODIGO	REF	MEDIDA/TIPO	UN.	PRECIO + IVA
17-01-020	14512	1/8" a 3/4"	Jgo. 6	

INFLADOR CABEZA DOBLE
Cabeza metálica, cuerpo latón

Cabeza grande que facilita el ensamble en válvulas, llantas de camión y microbús



CODIGO	REF	MEDIDA/TIPO	UN.	PRECIO + IVA
17-21-120	19089	1/4" NTP	Pza. 6	

IMÁN AUTOMOTRIZ
Extensible tipo bolígrafo

Levanta hasta 1,5 kg
Extensión máx. 620 mm



CODIGO	REF	MEDIDA/TIPO	UN.	PRECIO + IVA
17-21-100	14140	620 mm	Pza. 6	

LLAVE DE BANDA
Para filtro de aceite

No daña tubos ni conexiones pulidas
Diámetro: 1.1/2" a 6.1/2"



CODIGO	REF	MEDIDA/TIPO	UN.	PRECIO + IVA
17-21-110	15818	255 mm	Pza. 1	

INFLADOR- CALIBRADOR PROFESIONAL

- Válvula de liberación de presión
- Cuerda 1/4 NTP
- Presión máxima 120 PSI



Medidor de mirilla para mejor precisión

CODIGO	REF	MEDIDA/TIPO	UN.	PRECIO + IVA
17-21-125	19028	1/4 NTP	Pza. 1	

LLAVE DE FILTRO UNIVERSAL

Quijadas recubiertas de vinil para mejor agarre

ESPECIFICACIONES:
Diámetro mínimo: 2.1/2"
Diámetro máximo: 3.7/8"



CODIGO	REF	MEDIDA/TIPO	UN.	PRECIO + IVA
17-21-115	14546	-	Pza. 4	

LLAVE BANDA METÁLICA
Para filtro de aceite

- Mango cubierto de vinil
- Banda de acero al carbono



Mango giratorio cubierto de vinil

CODIGO	REF	MEDIDA/TIPO	UN.	PRECIO + IVA
17-21-111	14515	3.1/4"	Pza. 6	

INFLADOR CON CLIP
Cuerpo de latón, clip de acero



CODIGO	REF	MEDIDA/TIPO	UN.	PRECIO + IVA
17-21-132	19026	1/4 NTP	Pza. 6	

MEDIDOR DE PRESIÓN
Cabeza doble



Regleta de aluminio

CODIGO	REF	MEDIDA/TIPO	UN.	PRECIO + IVA
17-21-122	19098	50 lb 6-50 PSI	Pza. 12	
17-21-124	19099	120 lb 10-120 PSI	Pza. 12	

RECTIFICADOR P/CILINDRO DE MOTOR



CODIGO	REF	MEDIDA/TIPO	UN.	PRECIO + IVA
17-21-128	14533	2" a 7"	Pza. 1	

Repuesto 3 piedras

CODIGO	REF	MEDIDA/TIPO	UN.	PRECIO + IVA
17-21-129	14534	-	Pza. 6	

LLAVE UNIVERSAL
Con cadena 300 mm

- Cuerpo de acero
- Cromo-molibdeno
- Hasta diámetro de 4.3/4"



Caja máster: 4 unidades

CODIGO	REF	MEDIDA/TIPO	UN.	PRECIO + IVA
17-21-112	15515	300 mm	Pza. 1	

LLAVE FRANCESA TRUPER
Forjada en acero carbono

Cómodo mango de vinil
acojinado con grip



CODIGO	REF	MEDIDA/TIPO	UN.	PRECIO + IVA
17-01-089	15509	6"	Pza. 6	
17-01-090	15510	8"	Pza. 6	
17-01-092	15511	10"	Pza. 6	
17-01-093	15512	12"	Pza. 6	

MINI GRASERA

Incluye cartucho de 85 g - 3 oz

Sistema de carga con
cartucho o a granel
3000 PSI



2 Posiciones
de salida:
frontal y superior

CODIGO	REF	MEDIDA/TIPO	UN.	PRECIO + IVA
17-01-037	14911	85 g - 3 oz	Pza. 4	

Cartucho de repuesto

17-01-038	14912	85 g - 3 Oz	Pza. 6	
-----------	-------	-------------	--------	--

ENGRASADORA INDUSTRIAL 14 OZ

Mango con cubierta antiderrapante

Niple de llenado

14861 incluye extensión
flexible y válvula para purgar

Caja máster: 2 unidades



CODIGO	REF	MEDIDA/TIPO	UN.	PRECIO + IVA
17-01-040	14860	8.000 PSI	Pza. 1	
17-01-041	14861	10.000 PSI	Pza. 1	

EXTENSIÓN FLEXIBLE PARA GRASERAS



CODIGO	REF	MEDIDA/TIPO	UN.	PRECIO + IVA
17-01-039	14862	12"	Pza. 6	

BOMBA INYECTORA DE GRASA
Alta presión

Presión de salida: 5800 PSI

Flujo: 3.1 g

Manguera de 1/4" x 2.17 ml



CODIGO	REF	MEDIDA/TIPO	UN.	PRECIO + IVA
17-01-042	16850	24 kg	Pza. 1	

JUEGO DE DADOS 1/2"

25 Piezas en estuche metálico

- Acero cromo vanadio
- Estuche con bisagra de cierre automático

INCLUYE:

- 10 dados de 12 puntas de 3/8" a 1"
- 8 dados de 6 puntas de 10 a 17mm
- 2 dados para bujías de 5/8" y 13/16"
- 1 matraca
- 1 mango articulado 17"
- 1 nudo universal
- 2 extensiones de 5" y 10"
- 1 estuche metálico

Caja máster: 5 Juegos



CODIGO	REF	MEDIDA/TIPO	UN.	PRECIO + IVA
17-01-222	13938	1/2"	Jgo. 1	

CARRO DE SERVICIO
3 bandejas

- Llantas de alto impacto con freno manual
- Lámina calibre 21

ESPECIFICACIONES:

Medida bandeja: 71 x 36 x 8.5 cm
Capacidad de carga: 120 kg



CODIGO	REF	MEDIDA/TIPO	UN.	PRECIO + IVA
17-21-140	11528	120 kg	Pza. 1	

CAMA PARA TALLER

Con colchón

- Cuerpo acolchado con soporte para cabeza
- Ruedas giratorias en 360°

Caja máster: 2 unidades



CODIGO	REF	MEDIDA/TIPO	UN.	PRECIO + IVA
17-21-130	10097	40 x 16" / 130kg	Pza. 1	

GATA HIDRÁULICA



CODIGO	REF	MEDIDA/TIPO	UN.		PRECIO + IVA
17-21-053	14810	2 t	Pza.	1	
17-21-051	14812	4 t	Pza.	1	
17-21-049	14814	6 t	Pza.	1	
17-21-047	14816	8 t	Pza.	1	
17-21-045	14822	12 t	Pza.	1	
17-21-043	14822	21 t	Pza.	1	
17-21-041	14819	32 t	Pza.	1	

GATA HIDRÁULICA TIPO PATÍN
2 toneladas

ESPECIFICACIONES:
Altura mínima: 135 mm
Altura máxima: 320 mm



CODIGO	REF	MEDIDA/TIPO	UN.		PRECIO + IVA
17-21-086	14944	2 t	Pza.	1	

GATA HIDRÁULICA TIPO PATÍN
3 toneladas con maletín

ESPECIFICACIONES:
Altura mínima: 192 mm
Altura máxima: 540 mm



CODIGO	REF	MEDIDA/TIPO	UN.		PRECIO + IVA
17-21-090	14947	3 t	Pza.	1	

SOPORTE PARA AUTO TIPO TORRE

Caja con 1 par



Caja máster: 2 unidades

CODIGO	REF	MEDIDA/TIPO	UN.		PRECIO + IVA
17-21-073	14843	3 t	Par	1	
17-21-075	14845	6 t	Par	1	

GATA HIDRÁULICA TIPO PATÍN
2 toneladas con maletín

ESPECIFICACIONES:
Altura mínima: 125 mm
Altura máxima: 355 mm



CODIGO	REF	MEDIDA/TIPO	UN.		PRECIO + IVA
17-21-088	14826	2 t	Pza.	1	

PORTO POWER HIDRÁULICO

10 toneladas

- Para enderezar carrocerías y trabajo de hojalatería
- Accesorios interconectables



CODIGO	REF	MEDIDA/TIPO	UN.		PRECIO + IVA
17-21-099	14841	10 t	Pza.	1	

COMPRESOR/LINTERNA PORTÁTIL

Incluye estuche

- Tiempo aproximado de llenado de una llanta de auto: **3 min** Máximo
- Manómetro en escala PSI
- Incluye **3 válvulas**

Capacidad	35 L/min.
tensión	12 V
Máxima Presión	150 PSI
Manguera	1.2 m
Cable	1.9 m



CODIGO	REF	MEDIDA/TIPO	UN.	PRECIO + IVA
17-21-134	19999	150 PSI / 12V	Pza. 1	

ASPIRADORA PARA AUTO

Incluye expansión con cepillo y filtro lavable

Potencia	60 w
Tensión	12 v
Cap. del deposito	600 ml
Cable	5 metros



Caja máster: 4 unidades

CODIGO	REF	MEDIDA/TIPO	UN.	PRECIO + IVA
17-21-118	22090	-	Pza. 1	

SELLADOR E INFLADOR DE NEUMÁTICOS

- Repara temporalmente fugas y pinchaduras hasta 6 mm en llantas de aro 13" a 16"

- Dura hasta **2 años**



No daña la capa de ozono



CODIGO	REF	MEDIDA/TIPO	UN.	PRECIO + IVA
18-21-150	10940	340 g - 12 oz	Pza. 6	

LIQUIDO PROTECTOR DE VINIL



- Limpian y dan brillo natural a superficies de vinil, plástico o piel
- No dejan superficies grasosas
- Ideales para tableros, molduras y neumáticos



CODIGO	REF	MEDIDA/TIPO	UN.	PRECIO + IVA
17-21-052	57094	240 ml	Pza. 6	

SHAMPOO PARA AUTO



- Para lavado de carrocerías de autos y camiones
- Elimina polvo y suciedad
- Fórmula concentrada, diluible hasta 1:40
- Biodegradable



CODIGO	REF	MEDIDA/TIPO	UN.	PRECIO + IVA
17-21-050	57084	473 ml	Pza. 6	

TOLDO POLIETILENO
Sombra 80%

FIERO



CODIGO	REF	MEDIDA/TIPO	UN.	PRECIO + IVA
17-21-162	44709	3.60 x 5 m	Pza. 1	

LONA MULTIUSO
Fabricada en polietileno

PRETUL®

- Esquinas de polietileno con ojillos de aluminio

ESPECIFICACIONES
Hilos por pulgada: 10 x 10
Gramaje: 110 g/m²
Espesor: 0.14 mm



CODIGO	REF	MEDIDA/TIPO	UN.	PRECIO + IVA
17-21-150	23732	3 x 3 m / azul	Pza. 4	
17-21-151	23733	3 x 4 m / azul	Pza. 4	
17-21-152	23778	3 x 5 m / azul	Pza. 4	
17-21-154	23735	4 x 6 m / azul	Pza. 2	

BOLA DE ARRASTRE
Acabado cromado



CODIGO	REF	MEDIDA/TIPO	UN.	PRECIO + IVA
17-21-001	44441	1.7/8" - 2.000 lb	Pza. 4	
17-21-004	44440	2" - 3.500 lb	Pza. 4	

ACOPLADOR PARA BOLA
Acabado galvanizado



CODIGO	REF	MEDIDA/TIPO	UN.	PRECIO + IVA
17-21-010	44443	1.7/8"	Pza. 4	
17-21-013	44442	2"	Pza. 4	

TRIANGULO DE SEGURIDAD
29 cm



CODIGO	REF	MEDIDA/TIPO	UN.	PRECIO + IVA
17-21-020	10943	29 cm	Pza. 4	

CABLE PASA CORRIENTE



CODIGO	REF	MEDIDA/TIPO	UN.	PRECIO + IVA
17-21-026	17543	3 m - 8 AWG	Pza. 2	
17-21-028	17544	3,5 m - 6 AWG	Pza. 2	

CABLE PASA CORRIENTE

PRETUL®



CODIGO	REF	MEDIDA/TIPO	UN.	PRECIO + IVA
17-21-034	22808	2,5 m - 10 AWG	Pza. 5	

TERMINALES PLOMO P/BATERÍA **PRETUL®**
2 Piezas

- Para cable de 6 a 1 AWG
- Peso: 90 g



CODIGO	REF	MEDIDA/TIPO	UN.	PRECIO + IVA
17-21-038	23041	-	Jgo. 6	

TOPE DE ESTACIONAMIENTO

Fabricado en hule de alta resistencia

- Resistente contra rayos UV, humedad, aceite y temperaturas extremas
- Diseñado para no dañar la fascia de los vehículos
- Armado en una sola pieza
- Cinta reflejante de alta visibilidad

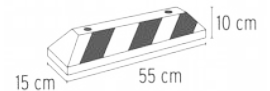

CODIGO	REF	MEDIDA/TIPO	UN.	PRECIO + IVA
17-21-240	101592	-	Pza. 1	

PRENSA RESORTE

Cuerpo de nylon, perno metálico



CODIGO	REF	MEDIDA/TIPO	UN.	PRECIO + IVA
17-02-400	17700	Largo 4" / ap. 2"	Pza. 4	
17-02-402	17701	Largo 6" / ap. 3"	Pza. 4	
17-02-404	17702	Largo 8" / ap. 4"	Pza. 4	

TORNILLO DE CARPINTERO

Cabeza de 2 piezas fundidas en hierro gris con huesillo maquinado



CODIGO	REF	MEDIDA/TIPO	UN.	PRECIO + IVA
17-02-110	17745	16"	Pza. 2	

DIABLITO

Uñas pulidas

Cuerpo hexagonal



CODIGO	REF	MEDIDA/TIPO	UN.	PRECIO + IVA
17-02-036	10853	3/4" x 45 cm	Pza. 3	
17-02-038	10856	3/4" x 60 cm	Pza. 3	
17-02-039	10859	3/4" x 75 cm	Pza. 3	
17-02-040	10862	3/4" x 90 cm	Pza. 3	

ESCUADRA IMANTADA

Cuerpo metálico



CODIGO	REF	MEDIDA/TIPO	UN.	PRECIO + IVA
17-02-061	15407	4"	Pza. 4	
17-02-062	15408	5"	Pza. 4	

ESCUADRA PARA CARPINTERO

Acero inoxidable

Mango aluminio
Graduación grabada en láser



CODIGO	REF	MEDIDA/TIPO	UN.	PRECIO + IVA
17-02-052	14370	6"	Pza. 6	
17-02-053	14372	8"	Pza. 6	
17-02-054	14374	10"	Pza. 6	
17-02-055	14376	12"	Pza. 6	

ESCUADRA FALSA

Acero inoxidable

- Ideal para ajustar y trasladar ángulos
- Mango plástico
- Gota de nivelación



CODIGO	REF	MEDIDA/TIPO	UN.	PRECIO + IVA
17-02-060	14382	8"	Pza. 5	

PRENSA DE HIERRO

Para carpintero



CODIGO	REF	MEDIDA/TIPO	UN.	PRECIO + IVA
17-02-087	17660	3"	Pza. 3	
17-02-088	17661	4"	Pza. 3	
17-02-089	17662	5"	Pza. 3	
17-02-090	17663	6"	Pza. 3	
17-02-092	17664	8"	Pza. 3	

PRENSA DE HIERRO MINI

Para carpintero



CODIGO	REF	MEDIDA/TIPO	UN.	PRECIO + IVA
17-02-094	17658	1"	Pza. 6	
17-02-096	17659	2"	Pza. 6	

PRENSA ESQUINERA

Ideal para unión de marcos

- Cuerpo de aluminio
- Cuerpo de ajuste
- fabricado en acero



CODIGO	REF	MEDIDA/TIPO	UN.	PRECIO + IVA
17-02-098	17690	3"	Pza. 6	

PRENSA SARGENTO GALVANIZADA

Mordazas y base del tornillo de hierro nodular



Caja máster: 6 unidades

CODIGO	REF	MEDIDA/TIPO	UN.	PRECIO + IVA
17-02-104	17735	60 cm	Pza. 2	
17-02-105	17736	90 cm	Pza. 2	
17-02-106	17737	120 cm	Pza. 2	
17-02-107	17738	150 cm	Pza. 2	
17-02-108	17739	180 cm	Pza. 2	

BROCA PLANA
Acero de alto carbono

Para taladros de 1.500 a 2.000 rpm



Filos angulados



Zanco hexagonal



CODIGO	REF	MEDIDA/TIPO	UN.		PRECIO + IVA
17-02-001	11363	5/16"	Pza.	6	
17-02-002	11360	1/4"	Pza.	6	
17-02-003	11366	3/8"	Pza.	6	
17-02-004	11369	7/16"	Pza.	6	
17-02-005	11372	1/2"	Pza.	6	
17-02-007	11375	5/8"	Pza.	6	
17-02-009	11378	3/4"	Pza.	6	
17-02-011	11381	7/8"	Pza.	6	
17-02-013	11384	1"	Pza.	6	
17-02-015	11387	1.1/8"	Pza.	6	
17-02-017	11390	1.1/4"	Pza.	6	
17-02-018	11393	1.1/2"	Pza.	6	

CEPILLO CORRUGADO P/CARPINTERO
Incluye 2 cuchillas

Base de hierro dúctil



Caja máster: 2 unidades

CODIGO	REF	MEDIDA/TIPO	UN.		PRECIO + IVA
17-02-044	12009	#4 - 2"	Pza.	1	
17-02-045	12015	#5 - 2"	Pza.	1	

BERBIQUÍ
Modelo profesional

Mecanismo tipo matraca
Barril y manivela de madera



CODIGO	REF	MEDIDA/TIPO	UN.		PRECIO + IVA
17-02-160	10970	12"	Pza.	3	

FORMÓN
Mango confort grip

- Acero cromo vanadio
- Longitud de hoja: 100 mm



Tapa de acero para golpe



CODIGO	REF	MEDIDA/TIPO	UN.		PRECIO + IVA
17-02-066	14615	1/4"	Pza.	3	
17-02-067	14618	3/8"	Pza.	3	
17-02-069	14621	1/2"	Pza.	3	
17-02-070	14624	5/8"	Pza.	3	
17-02-072	14627	3/4"	Pza.	3	
17-02-073	14630	7/8"	Pza.	3	
17-02-075	14633	1"	Pza.	3	
17-02-078	14636	1.1/4"	Pza.	3	
17-02-081	14639	1.1/2"	Pza.	3	

JUEGO DE 3 FORMONES
Acero al carbono

- Longitud de hoja: 64 mm
- Tapa metálica para golpe



CODIGO	REF	MEDIDA/TIPO	UN.		PRECIO + IVA
17-02-065	29974	1/2" - 3/4" - 1"	Jgo.	3	

LÁPIZ CARPINTERO BICOLOR
2 unidades

- Diseño hexagonal
- Bicolor (Azul | Rojo)



CODIGO	REF	MEDIDA/TIPO	UN.		PRECIO + IVA
17-02-500	101685	18 cm	Set2	12	

CRAYÓN INDUSTRIAL ROJO
2 unidades

Para marcar sobre madera, metal, vidrio, acrílico, y superficies rugosas



CODIGO	REF	MEDIDA/TIPO	UN.		PRECIO + IVA
17-02-502	101687	12 x 1.2 cm	Set2	10	

PRETUL®

SIERRA CIRCULAR

Para madera

Dientes de carburo de tungsteno

Soldadura de alta frecuencia que brinda 50% más resistencia al desprendimiento



Biselado alterno:
La sierra alterna un diente hacia la derecha y otro a la izquierda



Madera

CODIGO REF MEDIDA/TIPO UN. PZA. PRECIO + IVA

DIAMETRO 7.1/4"

17-02-155	18298	5/8" - 16 dts	Pza.	3	
17-02-157	18300	5/8" - 24 dts	Pza.	3	
17-02-159	18318	5/8" - 30 dts	Pza.	3	
17-02-161	18301	5/8" - 40 dts	Pza.	3	
17-02-163	18324	5/8" - 60 dts	Pza.	3	

DIAMETRO 10"

17-02-165	18307	1" - 40 dts	Pza.	3	
-----------	-------	-------------	------	---	--

DIAMETRO 12"

17-02-170	18311	1" - 40 dts	Pza.	3	
-----------	-------	-------------	------	---	--

DIAMETRO 14"

17-02-175	18322	1" - 40 dts	Pza.	2	
-----------	-------	-------------	------	---	--

ARCO CALADOR

Incluye 5 hojas sierra de 6"

Hojas sierra de 6" para cortar cualquier material: extrafina, fina, mediana y para metal



CODIGO REF MEDIDA/TIPO UN. PZA. PRECIO + IVA

17-02-152	20000	6"	Pza.	6	
-----------	-------	----	------	---	--

ARCO CALADOR

Incluye 5 hojas sierra de 6.1/2"

Hojas sierra de 6.1/2" para cortar cualquier material: extrafina, fina, mediana y para metal



CODIGO REF MEDIDA/TIPO UN. PZA. PRECIO + IVA

17-02-380	10221	6.1/2"	Pza.	6	
-----------	-------	--------	------	---	--

Set repuesto 8 seguetas

17-02-382	10229	6.1/2"	Set	12	
-----------	-------	--------	-----	----	--

PRETUL

SET HOJAS SIERRAS CALADORA ELÉCTRICA

5 piezas, con toma tipo "U"

Acero cromo vanadio
Para madera



CODIGO REF MEDIDA/TIPO UN. PZA. PRECIO + IVA

Corte recto

17-02-178	18136	6 dpp	Set	10	
17-02-180	18137	8 dpp	Set	10	

Corte curvo

17-02-186	18134	14 dpp	Set	10	
-----------	-------	--------	-----	----	--

SET HOJAS SIERRAS CALADORA ELÉCTRICA

5 piezas, con toma tipo "T"

Acero cromo vanadio
Para madera



CODIGO REF MEDIDA/TIPO UN. PZA. PRECIO + IVA

Corte recto

17-02-192	18126	6 dpp	Set	10	
17-02-194	18127	8 dpp	Set	10	
17-02-190	18130	12 dpp	Set	10	

Corte curvo

17-02-182	18133	6 dpp	Set	10	
17-02-184	18131	12 dpp	Set	10	

SET HOJAS SIERRAS CALADORA ELÉCTRICA

16 piezas

Para cortes en metales, plásticos y aluminio

CONTENIDO:

- 1 sierra para madera, corte fino y curvo
- 2 sierras para madera, corte fino
- 3 sierras para madera, corte rápido
- 3 sierras para metal, corte suave
- 2 sierras para metal, corte rápido
- 3 sierras multiusos, corte rápido
- 1 sierra para pared de yeso y madera
- 1 sierra para corcho y vinil



CODIGO REF MEDIDA/TIPO UN. PZA. PRECIO + IVA

17-02-188	16129	toma tipo "U"	Set	6	
17-02-189	16705	toma tipo "T"	Set	6	

FRESA REDONDEADORA P/ MOLDURAS

Con guía



CODIGO	REF	MEDIDA/TIPO	UN.		PRECIO + IVA
17-02-200	11472	1"	Pza.	3	
17-02-202	11473	1.1/4"	Pza.	3	
17-02-204	11474	1.1/2"	Pza.	3	

FRESA REDONDEADORA

Con guía



CODIGO	REF	MEDIDA/TIPO	UN.		PRECIO + IVA
17-02-206	11469	1"	Pza.	3	
17-02-208	11470	1.1/4"	Pza.	3	
17-02-210	11471	1.1/2"	Pza.	3	

FRESA PARA PERFILAR

Con guía



CODIGO	REF	MEDIDA/TIPO	UN.		PRECIO + IVA
17-02-212	11479	1.1/8"	Pza.	3	
17-02-214	11480	1.3/8"	Pza.	3	

FRESA ROMANA

Con guía



CODIGO	REF	MEDIDA/TIPO	UN.		PRECIO + IVA
17-02-216	11482	1.3/8"	Pza.	3	

FRESA CLÁSICA P/ MOLDURAS

Con guía



CODIGO	REF	MEDIDA/TIPO	UN.		PRECIO + IVA
17-02-218	11486	1.1/8"	Pza.	3	

FRESA PARA MEDIAS CAÑAS

Con guía



CODIGO	REF	MEDIDA/TIPO	UN.		PRECIO + IVA
17-02-220	11464	1/2"	Pza.	3	

FRESA PARA BISELAR

Con guía



CODIGO	REF	MEDIDA/TIPO	UN.		PRECIO + IVA
17-02-222	11468	1.1/4"	Pza.	3	

FRESA PARA REBAJAR

Con guía



CODIGO	REF	MEDIDA/TIPO	UN.		PRECIO + IVA
17-02-224	11477	1.1/4"	Pza.	3	

FRESA PARA CUARTO RODÓN

Con guía



CODIGO	REF	MEDIDA/TIPO	UN.	PRECIO + IVA
17-02-226	11485	1.1/8"	Pza. 3	

FRESA DOBLE ROMANA

Con guía



CODIGO	REF	MEDIDA/TIPO	UN.	PRECIO + IVA
17-02-228	11481	1-3/8"	Pza. 3	

FRESA COLA DE MILANO



CODIGO	REF	MEDIDA/TIPO	UN.	PRECIO + IVA
17-02-234	11475	1/2"	Pza. 3	

FRESA RANURADO EN V



CODIGO	REF	MEDIDA/TIPO	UN.	PRECIO + IVA
17-02-236	11465	3/8"	Pza. 3	
17-02-238	11466	1/2"	Pza. 3	
17-02-240	11467	7/8"	Pza. 3	

FRESA PARA MEDIAS CAÑAS



CODIGO	REF	MEDIDA/TIPO	UN.	PRECIO + IVA
17-02-242	11460	1/4"	Pza. 3	
17-02-244	11461	3/8"	Pza. 3	
17-02-246	11462	1/2"	Pza. 3	
17-02-248	11463	3/4"	Pza. 3	

FRESA RECTA 2 FILOS



CODIGO	REF	MEDIDA/TIPO	UN.	PRECIO + IVA
17-02-250	11452	1/4" Mediana	Pza. 3	
17-02-252	11453	1/4" Larga	Pza. 3	
17-02-254	11454	5/16"	Pza. 3	
17-02-256	11455	3/8"	Pza. 3	
17-02-258	11456	1/2"	Pza. 3	
17-02-260	11457	5/8"	Pza. 3	
17-02-262	11459	3/4"	Pza. 3	

SET DE FRESAS P/ENSAMBLE MADERA

2 piezas



CODIGO	REF	MEDIDA/TIPO	UN.	PRECIO + IVA
17-02-230	10671	3/4"	Set 3	
17-02-232	10672	7/8"	Set 3	

SET DE FRESAS

6 piezas, en estuche de madera

Cuchillas de carburo de tungsteno K10

CONTENIDO:

- 1 Fresa recta 2 filos 1/4" x 3/4"
- 1 Fresa recta 2 filos 1/4" x 1"
- 1 Fresa recta 2 filos 1/2" x 1"
- 1 Fresa rebajadora con guía 1.1/4" x 1/2"
- 1 Fresa redondeadora con guía 1.1/4" x 5/8"
- 1 Fresa doble romana con guía 1.3/8" x 7/8"
- 1 Llave allen



Caja máster: 2 unidades

CODIGO	REF	MEDIDA/TIPO	UN.	PRECIO + IVA
17-02-264	11359	-	Set 1	

CARRETILLA

Uso pesado

- Lanta neumática reforzada con rin de 3 aspas, diseño robusto y resistente al desgaste, rodada con mayor estabilidad
- Soportes de uso pesado, mayor estabilidad en cualquier tipo de superficie
- Tacón estabilizador

ESPECIFICACIONES:

Concha de lámina calibre 21 (0.84 mm)
Bastidor calibre 16 (1.5 mm)
Llanta: 16" x 4"



Empaque optimizado para ahorrar espacio



Video de ensablado

CODIGO	REF	MEDIDA/TIPO	UN.	PRECIO + IVA
17-03-002	11740	127 L / 580kg	Pza. 1	
17-03-003	11752	156 L / 580kg	Pza. 1	

CARRETILLA DOBLE LLANTA

Uso pesado

- 2 Llantas neumáticas de rodada lisa
- Bastidores cuadrados de acero, con mangos confort grip
- Tacones estabilizadores
- Ideal para la Industria y Construcción

ESPECIFICACIONES:

Concha: 100 x 70 x 41 cm / calibre: 20 (0.91 mm)
Bastidor: Ancho 38.1mm / Largo: 157 cm
Llantas: 16" x 4"



CODIGO	REF	MEDIDA/TIPO	UN.	PRECIO + IVA
17-03-009	11250	227 L / 580 kg	Pza. 1	

LLANTA POLIURETANO ANTIPINCHADURAS

Para carretillas 11752 y 11250

INCLUYE:

- Rodamientos
- Rin de acero diametro 11"
- Eje de 5/8" x 13 cm (solo apto para 11752)



CODIGO	REF	MEDIDA/TIPO	UN.	PRECIO + IVA
17-03-200	19658	16" x 4"	Pza. 1	

Llanta neumática reforzada **PRETUL®**

Para carretillas 11752 y 11250

INCLUYE:

- Cámara
- Rodamientos
- Rin de acero diametro 8"
- Eje de 5/8" x 13 cm (solo apto para 11752)



CODIGO	REF	MEDIDA/TIPO	UN.	PRECIO + IVA
17-03-202	20583	16" x 4"	Pza. 1	

CARRETILLA

Rueda poliuretano solido

- Lanta imponchable suave y ligera de poliuretano con rin 3 aspas, facilita el acarreo y reduce la fatiga
- Puente que brinda mayor estabilidad

ESPECIFICACIONES:

Concha de lámina calibre 23 (0.68 mm)
Bastidor calibre 18 (1.21 mm)
Llanta: 13.1/2" x 3.1/4"



Empaque optimizado para ahorrar espacio



Video de ensablado

CODIGO	REF	MEDIDA/TIPO	UN.	PRECIO + IVA
17-03-004	20629	113 L / 350kg	Pza. 1	
17-03-005	20630	156 L / 350kg	Pza. 1	

JUEGO DE PALANCAS CAMBIO DE LLANTA

2 piezas



CODIGO	REF	MEDIDA/TIPO	UN.	PRECIO + IVA
17-03-206	11089	23 cm	Jgo. 6	

REPUESTO LLANTA REFORZADA **PRETUL®**



CODIGO	REF	MEDIDA/TIPO	UN.	PRECIO + IVA
17-03-204	20584	16" x 4"	Pza. 1	

REPUESTO CÁMARA PARA CARRETILLA



CODIGO	REF	MEDIDA/TIPO	UN.	PRECIO + IVA
17-03-001	11866	16"	Pza. 10	

CORTADOR DE AZULEJOS

- Base fabricada en acero con hule antiderrapante
- Cuchilla circular fabricada en carburo de tungsteno



Caja máster: 2 unidades

CODIGO	REF	MEDIDA/TIPO	UN.	PRECIO + IVA
17-03-023	20996	40 cm - 16"	Pza. 1	

CORTADOR DE AZULEJOS

Barras de acero sólido

- Cuchilla con recubrimiento de titanio
- Cuerpo resistente de lámina de acero
- Mango ergonómico



CODIGO	REF	MEDIDA/TIPO	UN.	PRECIO + IVA
17-03-010	12929	16" - 40 cm	Pza. 1	
17-03-011	16780	20" - 50 cm	Pza. 1	

PRETUL® KIT DE NIVELACIÓN PARA CERÁMICA

Asegura una colocación pareja y nivelada entre losetas y reduce el tiempo de colocación

INCLUYE
1 Tenaza
100 Anclas
100 Cuñas



Caja máster: 8 juegos

CODIGO	REF	MEDIDA/TIPO	UN.	PRECIO + IVA
17-03-022	100515	-	Jgo. -	

ANCLAS PLANAS PARA NIVELACIÓN

Bolsa 100 unidades

Para losetas de 3 mm hasta 12 mm



CODIGO	REF	MEDIDA/TIPO	UN.	PRECIO + IVA
17-03-024	100517	Separación 2 mm	Bol. 4	

CUÑAS PARA NIVELACIÓN

Bolsa 100 unidades

Cuñas reutilizables, que nivelan el azulejo y evitan el movimiento



CODIGO	REF	MEDIDA/TIPO	UN.	PRECIO + IVA
17-03-026	100518	87 x 16 mm	Bol. 4	

TENAZA PARA NIVELACIÓN DE CERÁMICA

6 posiciones

Fabricada de acero con mangos de polipropileno, que facilita la nivelación de azulejos en suelos y paredes durante la aplicación



Caja máster: 3 unidades

CODIGO	REF	MEDIDA/TIPO	UN.	PRECIO + IVA
17-03-029	100516	23 cm	Pza. 3	

LLANA RECTA
Mango madera



CODIGO	REF	MEDIDA/TIPO	UN.		PRECIO + IVA
17-03-062	15406	11" x 5"	Pza.	6	

LLANA RECTA
Mango plástico



CODIGO	REF	MEDIDA/TIPO	UN.		PRECIO + IVA
17-03-068	15412	11" x 5"	Pza.	6	

LLANA DIENTE CUADRADO
Mango madera



CODIGO	REF	MEDIDA/TIPO	UN.		PRECIO + IVA
17-03-066	15410	11" x 5"	Pza.	6	

LLANA DIENTE TRIANGULAR
Mango plástico



CODIGO	REF	MEDIDA/TIPO	UN.		PRECIO + IVA
17-03-070	15415	11" x 5"	Pza.	6	

LLANA FRAGUADORA
Mango plástico

Espesor: 7/16"



CODIGO	REF	MEDIDA/TIPO	UN.		PRECIO + IVA
17-03-076	25074	9.1/2" x 4"	Pza.	6	

PRETUL

LLANA DIENTE CUADRADO
Mango plástico



CODIGO	REF	MEDIDA/TIPO	UN.		PRECIO + IVA
17-03-072	15413	11" x 5"	Pza.	6	

CUCHARA "FILADELFIA"

PRETUL®



CODIGO	REF	MEDIDA/TIPO	UN.		PRECIO + IVA
17-03-610	21052	8"	Pza.	6	

ESPÁTULA PLÁSTICA
Fabricada en polipropileno

- Resistentes a solventes
- Ligeras y flexibles



CODIGO	REF	MEDIDA/TIPO	UN.		PRECIO + IVA
17-03-390	14443	2"	Pza.	6	
17-03-392	14444	3"	Pza.	6	
17-03-394	14445	4"	Pza.	6	

CUCHARA "CENTROAMERICANA" PRETUL®

ESPÁTULA FLEXIBLE

PRETUL®



Hoja a todo lo largo del mango para máxima resistencia



CODIGO	REF	MEDIDA/TIPO	UN.		PRECIO + IVA
17-03-611	20543	8"	Pza.	6	

CODIGO	REF	MEDIDA/TIPO	UN.		PRECIO + IVA
17-03-501	20322	1"	Pza.	6	
17-03-502	21515	2"	Pza.	6	
17-03-503	21516	3"	Pza.	6	
17-03-504	21517	4"	Pza.	6	
17-03-505	20323	5"	Pza.	6	

CUCHARA "YESERA"

PRETUL®



SET 4 ESPÁTULAS
Hojas acero alta flexibilidad

PRETUL®

Ideal para raspar, resanar y limpiar muros

MEDIDAS:
3.1/2" x 2"
3.1/2" x 3"
3.1/2" x 4"
3.1/2" x 5"
Espesor: 0.26 mm



CODIGO	REF	MEDIDA/TIPO	UN.		PRECIO + IVA
17-03-612	21049	9"	Pza.	6	

CODIGO	REF	MEDIDA/TIPO	UN.		PRECIO + IVA
17-03-500	24200	-	Set	6	

PORTAHERRAMIENTAS
12 compartimientos



- Fabricado con piel de lomo de búfalo para máxima resistencia
- Costuras remachadas para incrementar resistencia y durabilidad
- Espesor de carnaza: 1.8 mm

CODIGO	REF	MEDIDA/TIPO	UN.	PRECIO + IVA
17-03-220	11536	24 x 33 cm	Pza. 3	

PORTAHERRAMIENTAS POLIÉSTER
7 compartimientos



- Fabricado en poliéster de 600 deniers
- Forro interno de PVC
- Cosido y remachado para incrementar su resistencia y durabilidad
- Lavable

CODIGO	REF	MEDIDA/TIPO	UN.	PRECIO + IVA
17-03-236	15312	25 x 29 cm	Pza. 2	

FAJA
Tirantes ajustables



CODIGO	REF	MEDIDA/TIPO	UN.	PRECIO + IVA
17-03-043	14237	M	Pza. 2	
17-03-045	14238	L	Pza. 2	
17-03-046	10954	XL	Pza. 2	

PORTAHERRAMIENTAS
6 compartimientos



- Fabricado con piel de lomo de búfalo para máxima resistencia
- Costuras remachadas para incrementar resistencia y durabilidad
- Espesor de carnaza: 1.8 mm

CODIGO	REF	MEDIDA/TIPO	UN.	PRECIO + IVA
17-03-222	11533	25 x 28 cm	Pza. 4	

PORTAHERRAMIENTAS POLIÉSTER
20 compartimientos



- Fabricado en poliéster de 600 deniers
- Forro interno de PVC
- Cosido y remachado para incrementar su resistencia y durabilidad
- Lavable

CODIGO	REF	MEDIDA/TIPO	UN.	PRECIO + IVA
17-03-238	15314	28 x 62 cm	Pza. 2	

PISTOLA CALAFATEAR REFORZADA
Doble varilla de empuje y medición



CODIGO	REF	MEDIDA/TIPO	UN.	PRECIO + IVA
17-03-147	17558	-	Pza. 4	

JUEGO HERRAMIENTAS MUJER PRETUL®
8 piezas

Incluye maletín

CONTENIDO:

- 1 Desarmador de cruz
- 1 Desarmador plano
- 1 Alicata mecánico
- 1 Martillo ligero de uña curva
- 1 Huincha de medir: 3 m
- 1 Mini alicata de punta y corte: 5" (127 mm)
- 1 Tijeras: 5 1/2" (140 mm)
- 1 Llave ajustable: 6" (152 mm)



Caja máster: 8 Juegos



CODIGO	REF	MEDIDA/TIPO	UN.	PRECIO + IVA
17-03-800	21251	-	Jgo. 1	

PISTOLA CALAFATEAR ESQUELETO
Espiga de acero hexagonal



CODIGO	REF	MEDIDA/TIPO	UN.	PRECIO + IVA
17-03-149	17550	-	Pza. 12	

ARCO SIERRA

PRETUL®

- Dos posiciones de sierra: 90° y 180°
- Incluye sierra pretul de 24dpp



CODIGO	REF	MEDIDA/TIPO	UN.	PRECIO + IVA
17-03-360	20017	12"	Pza. 6	

ARCO SIERRA AJUSTABLE

Acero niquelado, diseño profesional

- Dos posiciones de sierra: 90° y 180°
- Ajustable a 8.1/2", 10" y 12"
- Mango ergonómico engomado
- Incluye sierra bimetálica de 18 dpp



CODIGO	REF	MEDIDA/TIPO	UN.	PRECIO + IVA
17-03-362	10230	12"	Pza. 3	

ARCO PROFESIONAL

Acero tubular

- Mango ergonómico inyectado en aluminio y asa secundaria para mayor control
- Tensión de sierra hasta 1200 kg/cm²
- Dos posiciones de sierra 90° y 180°



CODIGO	REF	MEDIDA/TIPO	UN.	PRECIO + IVA
17-03-364	10234	12"	Pza. 3	

MINI ARCO DE ALUMINIO

Para corte en espacios reducidos

Incluye sierra bimetálica de 18 dpp



CODIGO	REF	MEDIDA/TIPO	UN.	PRECIO + IVA
17-03-370	10236	12"	Pza. 6	

MINI ARCO PLÁSTICO

Para corte en espacios reducidos

Incluye sierra bimetálica de 24 dpp



CODIGO	REF	MEDIDA/TIPO	UN.	PRECIO + IVA
17-03-372	20002	12"	Pza. 6	

ARCO SIERRA JUNIOR

Incluye sierra de 24 dpp



CODIGO	REF	MEDIDA/TIPO	UN.	PRECIO + IVA
17-03-374	10210	6"	Pza. 6	

Repuesto set de 5 sierras

CODIGO	REF	MEDIDA/TIPO	UN.	PRECIO + IVA
17-03-376	10220	6"	Set. 12	

CAJA INGLETE

Para serruchos de 12"

- Fabricado en ABS
- Perforaciones en base para sujetar a banco de trabajo
- Sistema de almacenamiento para guardar serrucho



CODIGO	REF	MEDIDA/TIPO	UN.	PRECIO + IVA
17-03-380	20667	45°, 90° y 22.5°	Pza. 6	

SET DE SIERRAS BIMETAL

Blister con 2 piezas



CODIGO	REF	MEDIDA/TIPO	UN.	PRECIO + IVA
17-03-350	19699	12"-18 dts	Set 5	
17-03-352	19700	12"-24 dts	Set 5	

SET HOJAS SIERRAS CALADORA ELÉCTRICA
5 piezas, con toma tipo "U"

Acero grado herramienta
Para metal, plástico y aluminio



CODIGO	REF	MEDIDA/TIPO	UN.	PRECIO + IVA
17-03-410	18139	12 dpp	Set 10	
17-03-412	18138	14 dpp	Set 10	

SET HOJAS SIERRAS CALADORA ELÉCTRICA
5 piezas, con toma tipo "T"

Acero grado herramienta
Para metal, plástico y aluminio



CODIGO	REF	MEDIDA/TIPO	UN.	PRECIO + IVA
17-03-420	18132	8 dpp	Set 10	
17-03-422	18129	18 dpp	Set 10	
17-03-424	18128	21 dpp	Set 10	

CORTADOR VIDRIO

3 Ranuras de recorte

- Cuchilla de carburo de tungsteno de Ø 6.5 mm
- Diseño de dientes para remover bordes ásperos



CODIGO	REF	MEDIDA/TIPO	UN.	PRECIO + IVA
17-03-400	12953	5"	Pza. 12	

BROCA PARA VIDRIO Y AZULEJOS

Punta de carburo de tungsteno

Para cortes rápidos y sin astillamientos



CODIGO	REF	MEDIDA/TIPO	UN.	PRECIO + IVA
17-40-002	11700	3 mm - 1/8"	Pza. 6	
17-40-003	11701	5 mm - 3/16"	Pza. 6	
17-40-004	11702	6.5 mm - 1/4"	Pza. 6	
17-40-005	11703	8 mm - 5/16"	Pza. 6	
17-40-020	11704	9.5 mm - 3/8"	Pza. 6	

JUEGO DE BROCAS PLANAS

6 piezas

- Fabricadas de acero al alto carbono
- Medidas: 1", 7/8", 3/4", 5/8", 1/2" y 3/8"



PRETUL®



CODIGO	REF	MEDIDA/TIPO	UN.	PRECIO + IVA
17-40-030	28108	-	Jgo. 6	

DISCO DE CORTE METAL

Corte extra fino

- Fabricados de óxido de aluminio
- Para cortes rápidos y limpios



PRETUL®



CODIGO	REF	MEDIDA/TIPO	UN.	PRECIO + IVA
17-03-700	22348	4.1/2" x 1 mm	Pza. 20	
17-03-702	22344	4.1/2" x 1.2 mm	Pza. 10	
17-03-704	22345	4.1/2" x 1.6 mm	Pza. 10	
17-03-706	22347	9" x 2 mm	Pza. 10	

DISCO DESBASTE METAL

Uso general

- Fabricados de óxido de aluminio



PRETUL®



CODIGO	REF	MEDIDA/TIPO	UN.	PRECIO + IVA
17-03-710	29955	4.1/2" x 6.5 mm	Pza. 5	

DISCO DE CORTE MULTIPROPOSITO

Corte extra fino

- Fabricado de óxido de aluminio con carburo de silicio



CODIGO	REF	MEDIDA/TIPO	UN.	PRECIO + IVA
17-03-708	18651	4.1/2" x 1 mm	Pza. 10	

COMBO OCTOGONAL

Mango madera hickory americano

- Absorbente de impactos
- Caras maquinadas



CODIGO	REF	MEDIDA/TIPO	UN.		PRECIO + IVA
--------	-----	-------------	-----	--	--------------

Mango madera 12"

17-03-092	17045	2.5 lb	Pza.	4	
17-03-093	16507	3 lb	Pza.	4	
17-03-094	16508	4 lb	Pza.	4	

Mango madera 36"

17-03-081	16509	6 lb	Pza.	2	
17-03-083	16511	8 lb	Pza.	2	
17-03-085	16512	10 lb	Pza.	2	
17-03-086	16513	12 lb	Pza.	2	
17-03-087	16514	14 lb	Pza.	2	

COMBO OCTOGONAL

Mango fibra de vidrio

- Grip antiderrapante con doble inyección que reduce vibraciones
- Caras maquinadas
- Orificio para colgar



CODIGO	REF	MEDIDA/TIPO	UN.		PRECIO + IVA
--------	-----	-------------	-----	--	--------------

Mango fibra de vidrio 14"

17-03-100	19883	3 lb	Pza.	4	
17-03-102	16536	4 lb	Pza.	4	

Mango fibra de vidrio 36"

17-03-104	19884	6 lb	Pza.	2	
17-03-105	16538	8 lb	Pza.	2	
17-03-106	16540	10 lb	Pza.	2	
17-03-107	16542	12 lb	Pza.	2	
17-03-108	16546	16 lb	Pza.	2	

PICOTA ANGOSTA

Mango fibra de vidrio 36"

- Cabezas forjadas en acero al carbono
- Mangos de fibra de vidrio
- El diseño de los mangos permite un agarre seguro y cómodo



CODIGO	REF	MEDIDA/TIPO	UN.		PRECIO + IVA
--------	-----	-------------	-----	--	--------------

17-03-182	18646	33 mm – 5 lb	Pza.	4	
-----------	-----------------------	--------------	------	---	--

PICOTA ANCHA

Mango fibra de vidrio 36"

- Cabezas forjadas en acero al carbono
- Mangos de fibra de vidrio
- El diseño de los mangos permite un agarre seguro y cómodo



CODIGO	REF	MEDIDA/TIPO	UN.		PRECIO + IVA
--------	-----	-------------	-----	--	--------------

17-03-185	18631	70 mm – 2.5 lb	Pza.	4	
17-03-183	18647	110 mm – 5 lb	Pza.	4	

TAJADERA PARA LEÑA

Mango madera hickory americano



CODIGO	REF	MEDIDA/TIPO	UN.		PRECIO + IVA
--------	-----	-------------	-----	--	--------------

17-03-110	19796	16" / 3 lb	Pza.	4	
-----------	-----------------------	------------	------	---	--

TALACHO-HACHA

Mango madera hickory americano 14"

MEDIDAS:

Longitud del mango: 305 mm
Ancho del escoplo: 86 mm



CODIGO	REF	MEDIDA/TIPO	UN.		PRECIO + IVA
--------	-----	-------------	-----	--	--------------

17-03-112	19817	1.3 lb	Pza.	4	
-----------	-----------------------	--------	------	---	--

TALACHO-PUNTA

Mango madera hickory americano 14"



CODIGO	REF	MEDIDA/TIPO	UN.		PRECIO + IVA
--------	-----	-------------	-----	--	--------------

17-03-188	10927	14"	Pza.	4	
-----------	-----------------------	-----	------	---	--

MARTELINA PUNTA

Mango madera hickory americano 14"

MEDIDAS:

Longitud del mango: 305 mm
Cabeza: 0.465 kg



CODIGO	REF	MEDIDA/TIPO	UN.		PRECIO + IVA
--------	-----	-------------	-----	--	--------------

17-03-190	19818	1 lb	Pza.	4	
-----------	-----------------------	------	------	---	--

GRIFAS DE 2 BOCAS

Para doblar o enderezar varillas de acero



CODIGO	REF	MEDIDA/TIPO	UN.	PRECIO + IVA
17-03-300	19800	5/8" - 3/4"	Pza. 3	
17-03-301	10865	1/2" - 5/8"	Pza. 3	

CHUZO

Escoplos y puntas más agudas para terrenos duros

PESO
100 cm – 3,2 kg
150 cm – 6 kg
175 cm – 7.2 kg



CODIGO	REF	MEDIDA/TIPO	UN.	PRECIO + IVA
17-03-193	10750	7/8" x 100 cm	Pza. 2	
17-03-195	10759	1" x 150 cm	Pza. 2	
17-03-196	19963	1" x 175 cm	Pza. 2	

PUNTO PARA CONCRETO

- Acero SHE-1060
- Tratamiento térmico diferenciado en punta y cabeza



CODIGO	REF	MEDIDA/TIPO	UN.	PRECIO + IVA
17-03-017	13050	3/4" x 30 cm	Pza. 3	
17-03-018	13053	7/8" x 36 cm	Pza. 3	
17-03-016	13056	1" x 40 cm	Pza. 3	

CINCEL

- Acero cromo vanadio
- Cabeza grande que incrementa el área de impacto



CODIGO	REF	MEDIDA/TIPO	UN.	PRECIO + IVA
17-03-012	12142	3/4 x 8"	Pza. 6	
17-03-013	12145	3/4 x 10"	Pza. 6	
17-03-014	12148	3/4 x 12"	Pza. 6	

CINCEL CON PROTECTOR

- Acero cromo vanadio
- Absorbe vibraciones y protege la mano de golpes accidentales



CODIGO	REF	MEDIDA/TIPO	UN.	PRECIO + IVA
17-03-019	12172	3/4" x 12"	Pza. 4	
17-03-020	12175	7/8"x12"	Pza. 4	
17-03-021	12181	1"x12"	Pza. 4	

CINCEL LADRILLERO CON PROTECTOR

Acero cromo vanadio

- Acero cromo vanadio
- Absorbe vibraciones y protege la mano de golpes accidentales



CODIGO	REF	MEDIDA/TIPO	UN.	PRECIO + IVA
17-03-030	12187	2.3/4" x 10"	Pza. 4	

PINZA PARA TIERRA

Modelo	14234	14235
Capacidad	300A	500A
Longitud	210 mm	210 mm
Peso	361 g	388 g



CODIGO	REF	MEDIDA/TIPO	UN.	PRECIO + IVA
17-03-135	14235	500A	Pza. 4	
17-03-137	14234	300A	Pza. 4	

PINZA PARA TIERRA

PRETUL®

Modelo	24234	24235
Capacidad	300A	500A
Longitud	170 mm	210 mm
Peso	133 g	282 g



CODIGO	REF	MEDIDA/TIPO	UN.	PRECIO + IVA
17-03-138	24235	500A	Pza. 4	
17-03-139	24234	300A	Pza. 4	

PINZA PORTA ELECTRODO

Cuerpo robusto

Modelo	14232	14233
Capacidad	300A	500A
Longitud	253 mm	315 mm
Peso	519 g	840 g



CODIGO	REF	MEDIDA/TIPO	UN.	PRECIO + IVA
17-03-140	14233	500A	Pza. 1	
17-03-142	14232	300A	Pza. 1	

PINZA PORTA ELECTRODO

PRETUL®

Modelo	24232	24233
Capacidad	300A	500A
Longitud	229 mm	252 mm
Peso	340 g	445 g



CODIGO	REF	MEDIDA/TIPO	UN.	PRECIO + IVA
17-03-143	24233	500A	Pza. 1	
17-03-144	24232	300A	Pza. 1	

ESCUADRA DE COMBINACIÓN

Regla de acero inoxidable

- Caras rectificadas para ángulos de 45° y 90°
- Graduación estampada en acero
- Gota de nivelación



CODIGO	REF	MEDIDA/TIPO	UN.	PRECIO + IVA
17-03-028	14380	12"	Pza. 6	

ESCUADRA PARA CANTERO

Acero inoxidable

- Graduación estampada en acero
- Cantos rectificados



CODIGO	REF	MEDIDA/TIPO	UN.	PRECIO + IVA
17-03-032	14384	16" x 24"	Pza. 6	

REGLA DE ACERO INOXIDABLE

Tabla de conversión al reverso

ESPECIFICACIONES:
longitud 30 cm
espesor: 2.6 mm



CODIGO	REF	MEDIDA/TIPO	UN.	PRECIO + IVA
17-03-038	14387	30 cm	Pza. 12	

HUINCHA MEDIR CONTRA IMPACTO

Cinta protegida con doble capa de nylon para máxima duración



CODIGO	REF	MEDIDA/TIPO	UN.	PRECIO + IVA
17-03-049	14577	3 m	Pza. 6	
17-03-050	14578	5 m	Pza. 6	
17-03-051	14579	8 m	Pza. 6	
17-03-052	14582	10 m	Pza. 6	

HUINCHA MEDIR CONTRA IMPACTO

En display box



CODIGO	REF	MEDIDA/TIPO	UN.	PRECIO + IVA
17-03-650	102663	3 m	Pza. 24	
17-03-652	102664	5 m	Pza. 12	
17-03-654	102666	8 m	Pza. 6	

HUINCHA DE MEDIR LARGA

Cinta de fibra de vidrio, carcasa plástica

MEDIDAS:
Espesor: 0.47 mm
Ancho: 14.5 mm



CODIGO	REF	MEDIDA/TIPO	UN.	PRECIO + IVA
17-03-057	12639	30 m	Pza. 3	
17-03-058	12640	50 m	Pza. 3	

HUINCHA DE MEDIR LARGA CON MANGO

Cinta de fibra de vidrio, mango ergonómico

MEDIDAS:
Espesor: 0.40 mm
Ancho: 12.5 mm



CODIGO	REF	MEDIDA/TIPO	UN.	PRECIO + IVA
17-03-059	12646	30 m	Pza. 2	
17-03-060	12647	50 m	Pza. 2	
17-03-061	12645	100 m	Pza. 1	

CONTADOR MANUAL

Carcasa de acero resistente a impacto

Perilla y pantalla de ABS

ESPECIFICACIONES
Rango: 0 - 9999
Largo: 4.4 cm
Ancho: 3 cm
Peso: 60 g



CODIGO	REF	MEDIDA/TIPO	UN.	PRECIO + IVA
17-03-080	24990	4 dígitos	Pza. 6	

CONTADOR DE METROS 5 DÍGITOS

Rueda de poliuretano, mango plegable

- Contador automático en metros y decímetros
- Freno y botón de reinicio
- Ideal para terrenos irregulares



CODIGO	REF	MEDIDA/TIPO	UN.	PRECIO + IVA
17-03-055	15831	Rueda 12"	Pza. 1	

TIRALÍNEAS

Incluye bote de tiza azul, 4 oz



PRETUL®

HILO PARA ALBAÑIL
Polipropileno multifilamento

ESPECIFICACIONES:
Calibre: 18
Resistencia: 6,5 kg



NIVELES DE HILO
2 piezas

Gotas con mayor resistencia a la abrasión y al impacto



CODIGO	REF	MEDIDA/TIPO	UN.	PRECIO + IVA
17-03-168	28574	50 ft -15 m	Pza. 6	

CODIGO	REF	MEDIDA/TIPO	UN.	PRECIO + IVA
17-03-158	12989	165 m	Pza. 12	
17-03-159	12988	65 m	Pza. 12	

CODIGO	REF	MEDIDA/TIPO	UN.	PRECIO + IVA
17-03-129	17058	3"	Set 10	

TIRALÍNEAS
Cuerpo Plástico

Incluye nivel y tiza azul



PLOMADA DE LATÓN
Incluye punta de repuesto

Para topografía, plomearía y construcción



NIVEL DE ALUMINIO
Cuerpo de aluminio, protección ABS contra impacto

Tolerancia 0.001 mm/mm



CODIGO	REF	MEDIDA/TIPO	UN.	PRECIO + IVA
17-03-166	18574	30 m	Pza. 6	

CODIGO	REF	MEDIDA/TIPO	UN.	PRECIO + IVA
17-03-152	17071	340 g	Pza. 6	
17-03-153	17072	450 g	Pza. 6	

CODIGO	REF	MEDIDA/TIPO	UN.	PRECIO + IVA
17-03-115	17030	12"	Pza. 3	
17-03-117	17032	14"	Pza. 3	
17-03-119	17034	18"	Pza. 3	
17-03-121	17036	24"	Pza. 3	
17-03-123	17038	36"	Pza. 3	
17-03-125	17040	48"	Pza. 3	

TIRALÍNEAS PROFESIONAL
Doble engrane para rebobinado rápido

Incluye bote de tiza azul, 4 oz



PIGMENTOS PARA CEMENTO
Para cualquier material a base de cemento o cal

- Resistente a exteriores, rayos UV y materiales alcalinos
- Fácil de integrar la mezcla
- Ideal para pisos, adoquines, tejas, fachadas, blocks y tabiques



Mezcla: 1kg de pigmento x 5 a 10 kg de cemento

Caja máster: 12 unidades

CODIGO	REF	MEDIDA/TIPO	UN.	PRECIO + IVA
17-03-167	18575	30 m	Pza. 6	

CODIGO	REF	MEDIDA/TIPO	UN.	PRECIO + IVA
17-03-900	18072	Negro - 1 kg	Pza. 4	
17-03-902	18073	Amarillo - 1 kg	Pza. 4	
17-03-904	18074	Rojo oxido - 1 kg	Pza. 4	

NIVEL TORPEDO
Magnético

Puntas recubiertas de hule contra impactos



CODIGO	REF	MEDIDA/TIPO	UN.	PRECIO + IVA
17-03-114	17054	10"	Pza. 6	

REPUESTO PARA TIRALÍNEAS
Alta visibilidad

8 oz



CODIGO	REF	MEDIDA/TIPO	UN.	PRECIO + IVA
17-03-170	18576	Azul	Pza. 6	
17-03-172	18578	Rojo	Pza. 6	

ESCALERA DE ALUMINIO

91 Kg

- Plegables para fácil almacenamiento y transportación
- Barandal alto que brinda mayor estabilidad
- Con bloqueo de seguridad
- Peldaño grande de acero y peldaños antiderrapantes de aluminio
- Tacones plásticos antiderrapantes



CODIGO	REF	PELDAÑOS	UN.		PRECIO + IVA
17-20-102	16764	3	Pza.	-	
17-20-104	16765	4	Pza.	-	

ESCALERA DE ALUMINIO MULTIPROPÓSITO

150 Kg

- Peldaños antiderrapantes 1" (3 cm)
- Doble refuerzo en peldaños inferiores para mayor resistencia
- Parte inferior más ancha para mayor estabilidad
- Mecanismo de articulación con seguro

ESPECIFICACIONES

Altura: 3.2 m (10.5')
 Alcance máximo (extendida): 3.9 m (12.7')
 Alcance máximo (tijera): 2.8 m (9.1')
 Peso: 12 kg



CODIGO	REF	PELDAÑOS	UN.		PRECIO + IVA
17-03-197	101883	10	Pza.	-	

NIVEL LÁSER PROFESIONAL

Alcance 20 metros

- Carcasa plástica con cubierta de TPR
- Nivelación **automática**
- Coordenadas **horizontales, verticales y cruzadas**
- Luz ajustable para uso en **interior y exterior**
- Rosca de 1/4" para tripié
- Funda, cargador USB Y C.A.

ESPECIFICACIONES:

Autonivelación: $\pm 4^\circ$
 Base: 57 mm
 Altura: 95 mm
 Fondo: 98 mm



CODIGO	REF	MEDIDA/TIPO	UN.		PRECIO + IVA
17-03-127	17078	20 metros	Pza.	1	

MEDIDOR TEMPERATURA LÁSER

Pantalla digital

- Medición **sin contacto**, para puntos de difícil acceso o de riesgo
- Medición por **infrarrojo**
- Ideal para mantenimiento y reparación de calefacción, ventilación, aire acondicionado, control de almacenamiento de equipos electrónicos y eléctricos



ESPECIFICACIONES

Temperatura: -50°C a 500°C
 Unidades de temperatura: $^\circ\text{C}$ y $^\circ\text{F}$
 Radio óptico: 12:1
 Peso: 177 g

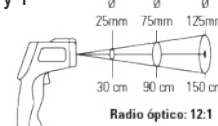

INCLUYE
 1 Pila 9V
 Estuche



CODIGO	REF	MEDIDA/TIPO	UN.		PRECIO + IVA
17-03-600	18229	500°C	Pza.	1	

PINTURA AEROSOL 300 ml

- 70% Pintura y 30% propelente
- Fácil aplicación y secado rápido
- Libres de plomo
- Anti-corrosión



CODIGO REF UN. PRECIO + IVA

Sólidos

18-04-200	27170	Negro brillante	Pza.	4	
18-04-202	27172	Negro mate	Pza.	4	
18-04-204	27171	Blanco brillante	Pza.	4	
18-04-206	27175	Blanco mate	Pza.	4	
18-04-208	27178	Azul Holandés	Pza.	4	
18-04-210	27182	Azul ultramar	Pza.	4	
18-04-212	27181	Naranja	Pza.	4	
18-04-214	27173	Rojo	Pza.	4	
18-04-216	27184	Verde hoja	Pza.	4	
18-04-218	27184	Tabaco	Pza.	4	

Metálicos

18-04-220	27180	Oro	Pza.	4	
18-04-222	27174	Plata	Pza.	4	
18-04-224	27177	Cromo	Pza.	4	

PRETUL® PINTURAS AEROSOL TRUPER 400 ml

- 70% Pintura y 30% propelente
- Fácil aplicación y secado rápido
- Libres de plomo
- Máxima cobertura
- Anti-corrosión



CODIGO REF UN. PRECIO + IVA

Sólidos

18-04-100	19031	Negro brillante	Pza.	12	
18-04-102	19033	Negro mate	Pza.	4	
18-04-104	19032	Blanco brillante	Pza.	4	
18-04-105	19034	Blanco mate	Pza.	12	
18-04-106	19037	Naranja	Pza.	4	
18-04-107	19038	Azul Holandés	Pza.	4	
18-04-108	19039	Azul claro	Pza.	4	
18-04-109	19041	Azul ultramar	Pza.	4	
18-04-110	19040	Rojo	Pza.	12	
18-04-112	19042	Amarillo colonial	Pza.	4	
18-04-113	19044	Gris oscuro	Pza.	4	
18-04-114	19045	Gris claro	Pza.	4	
18-04-115	19056	Gris primario	Pza.	8	
18-04-116	19046	Verde manzana	Pza.	4	
18-04-118	19047	Verde hoja	Pza.	4	
18-04-119	19050	Tabaco	Pza.	4	
18-04-120	19049	Amarillo canario	Pza.	8	
18-04-121	19043	Marfil	Pza.	4	
18-04-122	19270	Rojo taxi	Pza.	4	
18-04-135	19036	Transparente	Pza.	4	

Fluorescentes

18-04-150	19072	Naranja	Pza.	4	
18-04-152	19073	Verde	Pza.	4	
18-04-154	19074	Rosa	Pza.	4	

Metálicos

18-04-140	19066	Oro	Pza.	8	
18-04-143	19059	Plata	Pza.	8	
18-04-145	19067	Cobre	Pza.	4	
18-04-148	19053	Cromo	Pza.	8	

Alta temperatura Resistente hasta 400°C

18-04-097	18070	Negro	Pza.	4	
18-04-099	18071	Aluminio	Pza.	4	

CARTILLA DE COLORES (colores aproximados, solicite original al vendedor)

Sólidos:

Negro brillante	
Negro mate	
Blanco brillante	
Blanco mate	
Naranja	
Azul Holandés	
Azul claro	
Azul ultramar	
Rojo	
Amarillo colonial	
Gris oscuro	
Gris claro	
Gris primario	
Verde manzana	
Verde hoja	
Tabaco	
Amarillo canario	
Marfil	
Rojo taxi	
Transparente	

Fluorescentes:

Naranja	
Verde	
Rosa	

Metálicos:

Oro	
Plata	
Cobre	
Cromo	

Alta temperatura:

Negro	
Aluminio	

SET DE PINCELES
5 unidades

Mango de madera con casquillo de metal
Pelo extrafino para un mejor acabado
100% cerda natural



PINCELES	CERDA
Redondo #2	Natural
Redondo #4	Natural
Plano #1/4	Natural
Plano #1/2	Natural
Plano #1/2	Negra

CODIGO	REF	MEDIDA/TIPO	UN.	PRECIO + IVA
17-04-006	24740	-	Jgo	6

PINTAPAD
Para acabados uniformes

Mango ajustable con rosca
para extensión

MEDIDAS
Largo: 18 cm
Ancho: 9 cm



CODIGO	REF	MEDIDA/TIPO	UN.	PRECIO + IVA
17-04-026	19392	7"	Pza.	6
Repuesto				
17-04-027	19398	7"	Pza.	6

PRETUL® TIROLERA GALVANIZADA
Acabado ajustable de fino a grueso

Sistema de rodillos con aspas
intercaladas, permite mayor precisión
para acabados finos y rústicos



CODIGO	REF	MEDIDA/TIPO	UN.	PRECIO + IVA
17-04-028	13008	3,5 L	Pza.	1

PLÁSTIPROTECTOR
Fabricado en polietileno

Para proteger muebles, pisos, maquinaria, etc. al momento de pintar



CODIGO	REF	MEDIDA/TIPO	UN.	PRECIO + IVA
17-04-200	11108	5 x 2 m	Pza.	6
17-04-202	11109	5 x 3 m	Pza.	6

BANDEJA DE PLÁSTICO PARA RODILLO
Con canales para escurrimiento

- Gancho para escalera
- Para rodillos hasta 9"



CODIGO	REF	MEDIDA/TIPO	UN.	PRECIO + IVA
17-04-022	19211	41 x 6 x 29 cm	Pza.	12

REVOLVEDOR DE PINTURA
Cuerpo de acero

- ESPECIFICACIONES
- Diámetro mango: 3/8"
 - Diámetro cabeza: 10 cm
 - Altura: 55 cm

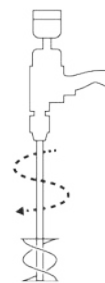

Para uso en taladros 1/2"

CODIGO	REF	MEDIDA/TIPO	UN.	PRECIO + IVA
17-04-010	15824	-	Pza.	4

RASPADOR PARA PLÁSTICO
Incluye navaja de 2.3/8"

PRETUL®

Limpia pegamento, pintura, silicón
y cemento de superficies lisas como
vidrio, azulejo, paredes y metal



CODIGO	REF	MEDIDA/TIPO	UN.	PRECIO + IVA
17-04-013	24055	-	Pza.	6

RASPADOR PARA VIDRIO
Cuerpo de acero cubierto de PVC

- Limpia pegamento, pintura,
silicona y cemento de superficies
lisas como vidrio, azulejo,
paredes y metal

- Incluye navaja de 1.1/2"



CODIGO	REF	MEDIDA/TIPO	UN.	PRECIO + IVA
17-04-015	16951	-	Pza.	6

Repuesto set de 5 navajas

17-04-017	16952	-	Set	6
-----------	-------	---	-----	---

CONECTORES PARA CABLE
Bolsa 20 unidades calibres surtidos



PIEZAS	CALIBRE	COLOR
4	8-10 AWG	ROJO
6	10-12 AWG	AMARILLO
4	12-14 AWG	NARANJA
3	14-16 AWG	AZUL
3	16-18 AWG	GRIS



CODIGO	REF	MEDIDA/TIPO	UN.	PRECIO + IVA
17-05-001	47330	-	Bolsa 10	

CONECTORES PARA CABLE
Bolsa 10 unidades



CODIGO	REF	MEDIDA/TIPO	UN.	PRECIO + IVA
17-05-004	47328	10-12 AWG	Bolsa 10	
17-05-007	47329	12-14 AWG	Bolsa 10	

TERMINALES AISLADAS P/CABLE
55 piezas en estuche plástico



- Aislamiento de PVC
- Incluye 5 piezas
- de cada terminal

TERMINAL	CALIBRE
Espada	22-16 AWG
Macho plano	16-14 AWG
Macho plano	22-16 AWG
Hembra plano	16-14 AWG
Hembra plano	22-16 AWG
Anillo	12-10 AWG
Anillo	16-14 AWG
Anillo	22-16 AWG
Tope	12-10 AWG
Tope	16-14 AWG
Tope	22-16 AWG



CODIGO	REF	MEDIDA/TIPO	UN.	PRECIO + IVA
17-05-080	48142	-	Jgo. 4	

ABRAZADERAS PLÁSTICAS
En bolsa



CODIGO	REF	MEDIDA	UN.	PRECIO + IVA
--------	-----	--------	-----	--------------

Negra

17-05-010	44320	2.5mm x 10cm	B100	20
17-05-011	44321	2.5mm x 15cm	B100	20
17-05-012	44322	2.5mm x 20cm	B100	20
17-05-013	44325	3.5mm x 25cm	B50	20
17-05-162	44328	4.5mm x 30cm	B50	20
17-05-166	44329	4.5mm x 35cm	B25	20
17-05-170	44330	4.5mm x 40cm	B25	20
17-05-174	44331	4.5mm x 50cm	B25	10
17-05-178	48989	4.8mm x 60cm	B25	10

Blanca

17-05-015	44300	2.5mm x 10cm	B100	10
17-05-016	44301	2.5mm x 15cm	B100	20
17-05-017	44302	2.5mm x 20cm	B100	20
17-05-022	44305	3.5mm x 25cm	B50	20
17-05-160	44308	4.5mm x 30cm	B50	20
17-05-164	44309	4.5mm x 35cm	B25	20
17-05-168	44310	4.5mm x 40cm	B25	20
17-05-172	44311	4.5mm x 50cm	B25	10
17-05-176	48980	4.8mm x 60cm	B25	10
17-05-184	48985	9mm x 45cm	B10	10
17-05-188	48986	9mm x 70cm	B10	10
17-05-192	48987	9mm x 90cm	B10	10

TUBOS CON ABRAZADERAS PLÁSTICAS
650 unidades



BLANCO	50 piezas de 28 cm 300 piezas de 20 cm 100 piezas de 10 cm
AMARILLO	50 piezas de 10 cm
ROJO	50 piezas de 10 cm
AZUL	50 piezas de 10 cm
VERDE	50 piezas de 10 cm



Caja máster: 12 tubos

CODIGO	REF	MEDIDA/TIPO	UN.	PRECIO + IVA
17-05-025	44298	-	Tubo 1	

PROBADOR DE CORRIENTE, SIN CONTACTO
90 a 1000 V C.A.

- Apagado automático en 2 minutos sin uso
- Indicador LED rojo y sonido al detectar voltaje
- Incluye 2 pilas AAA



CODIGO	REF	MEDIDA/TIPO	UN.	PRECIO + IVA
17-05-038	102141	15 cm	Pza. 6	

PROBADOR DE CORRIENTE
100-500V

- Punta de acero al cromo vanadio y mango acrílico transparente, aislado para mayor seguridad
- Indicador de luz con fusible
- Clip tipo pluma para portar en el bolsillo
- Funciona al tocar



CODIGO	REF	MEDIDA/TIPO	UN.	PRECIO + IVA
17-05-033	13988	14 cm	Pza. 12	

PROBADOR DE CORRIENTE
100-500V

- Punta fabricada en acero al cromo vanadio y mango acrílico transparente, aislado para mayor seguridad
- Indicador de luz con fusible



CODIGO	REF	MEDIDA/TIPO	UN.	PRECIO + IVA
17-05-034	13989	19 cm	Pza. 12	

GUÍA PARA CABLES

Cuerpo de polipropileno resistente al impacto

- Guía de acero SK5 de fácil arrastre
- Para jalar cables eléctricos y de Telecomunicaciones en ductos de instalación
- Mango ergonómico



CODIGO	REF	MEDIDA/TIPO	UN.	PRECIO + IVA
17-05-030	17751	15 m	Pza. 3	
17-05-031	17752	30 m	Pza. 3	

GUÍA PARA CABLE

Fabricado en nylon

- Para jalar cables en poliducto
- Facilita la instalación del cableado

ESPECIFICACIONES:
Diámetro: 1/8"
Tracción: 120 kg



Caja máster: 24 un.

CODIGO	REF	MEDIDA/TIPO	UN.	PRECIO + IVA
17-05-070	17755	10 m	Pza. 3	
17-05-072	17757	20 m	Pza. 2	
17-05-074	17758	30 m	Pza. 1	

CINTA AISLADORA

Fabricadas en PVC con base de adhesivo acrílico

ESPECIFICACIONES:
Medidas: 19 mm x 18 m
Espesor: 0.18 mm
Resistencia: 6.5 Kg



Caja máster: 48 un.

CODIGO	REF	MEDIDA/TIPO	UN.	PRECIO + IVA
17-05-300	12500	Negra	Pza. 8	
17-05-302	12506	Blanca	Pza. 8	
17-05-304	12503	Amarilla	Pza. 8	
17-05-306	12507	Gris	Pza. 8	
17-05-308	12504	Rojo	Pza. 8	
17-05-310	12505	Azul	Pza. 8	
17-05-312	12502	Verde	Pza. 8	

CINTA AISLADORA REFORZADA
2X Más resistente



ESPECIFICACIONES:
Medidas: 19 mm x 18 m
Espesor: 0.20 mm
Resistencia: 8 Kg



Caja máster: 48 un

CODIGO	REF	MEDIDA/TIPO	UN.	PRECIO + IVA
17-05-314	19954	Negra	Pza. 8	

GABINETE METÁLICO
Incluye pernos de anclaje

- Para aplicaciones eléctricas en industria, centros comerciales, hotelería, edificios, etc
- sellado de poliuretano
- Bisagra que permite una abertura en 90°



IP 66



Cierre con llave tipo palomilla

CODIGO	REF	MEDIDA/TIPO	UN.	PRECIO + IVA
17-05-042	46383	40 x 30 x 20 cm	Pza. 1	

ABRAZADERA TIPO OMEGA PARA TUBO
Acero galvanizado

- Ideal para fijar y soportar instalaciones de tubo conduit



CODIGO	REF	MEDIDA/TIPO	UN.	PRECIO + IVA
--------	-----	-------------	-----	--------------

Bolsa 10 Unidades

17-01-140	46926	3/8"	Bolsa 10	
17-01-142	46923	1/2"	Bolsa 10	
17-01-144	46924	3/4"	Bolsa 10	
17-01-146	46925	1"	Bolsa 10	

Bolsa 5 Unidades

17-01-148	46030	1.1/4"	Bolsa 10	
17-01-150	46031	1.1/2"	Bolsa 10	
17-05-212	46032	2" x 1.2 mm	Pza. 10	
17-05-214	46928	3" x 1 mm	Pza. 10	
17-05-216	46929	4" x 1 mm	Pza. 10	

CANAleta P/CABLE ELÉCTRICO
Fabricadas de PVC resistentes a impactos

Largo: 2 metros



Dieléctricas



Antiflama

CODIGO	REF	MEDIDA/TIPO	UN.	PRECIO + IVA
17-05-412	46280	10 x 20 mm	Pza. 20	
17-05-414	46282	17 x 35 mm	Pza. 10	

PANEL LED COLGANTE CUADRADO
Diseño ultra delgado



- Cuerpo de aluminio
- Pantalla de polipropileno
- Incluyen driver y tirantes para instalación

LED



Incluyen driver y tirantes para instalación

Caja máster: 4 un.

CODIGO	REF	MEDIDA/TIPO	UN.	PRECIO + IVA
17-05-050	48549	1 x 60 x 60 cm	Pza. 1	

LUZ DE NOCHE 3 LED
Con sensor de movimiento



LED

- Base magnética para superficies metálicas
- incluye accesorios para montaje

ESPECIFICACIONES

Medidas: 11 x 11 cm
Ángulo detección: 100°
Tiempo activado: 20 s
Alcance: 3 m
Utiliza 3 pilas AAA (no incluidas)



Caja máster: 6 un.

CODIGO	REF	MEDIDA/TIPO	UN.	PRECIO + IVA
17-05-054	46157	8 lm	Pza. 1	

LÁMPARA DE TRABAJO LED
Incluye pila recargable

- Duración máx. 3 horas en modo low.
- Puerto USB que funciona como cargador de teléfono
- Batería Ion litio de 3,000 mAh (incluida)

Modos de iluminación



Caja máster: 6 un.

CODIGO	REF	MEDIDA/TIPO	UN.	PRECIO + IVA
17-05-052	14631	1600 lm	Pza. 1	

LUZ SOLAR LED
Con sensor de luz y movimiento



- Cuerpo de ABS y pantalla de policarbonato
- Encendido automático al anochecer mayor velocidad de carga
- Incluye tornillería

ESPECIFICACIONES

Corriente: 780 mA
Temperatura de color: 6,500 k / Luz de día
Fuente de luz: LED integrado x 8
Duración de la batería: 9 h
Grado IP: 44
Distancia de detección (Alcance): 3 m
Rango de detección: 130°



Caja máster: 2 unidades

CODIGO	REF	MEDIDA/TIPO	UN.	PRECIO + IVA
17-05-059	49073	1.1 W / 170 lm	Pza. 1	

LUZ SOLAR LED
Con sensor de luz y movimiento



- Cuerpo y pantalla de policarbonato
- Soporte de acero para ajustar luminario (incluye tornillería)

ESPECIFICACIONES

Distancia de detección: 5 m
Tiempo de uso continuo: 10 h
Tiempo de vida: 35,000 h
Temperatura de color: 6,500 k /Luz de día
Ángulo de detección: 160°
Altura de instalación: 3 a 6 m
Tiempo de carga: 8 h
Grado IP: 65



Caja máster: 2 unidades

CODIGO	REF	MEDIDA/TIPO	UN.	PRECIO + IVA
17-05-066	46958	15 W / 2000 lm	Pza. 1	

LUZ ARBOTANTE SOLAR 2 LED
Con sensor de movimiento



- Cuerpo de acero inoxidable
- Base para montarse a la pared (incluye tornillería)
- Encendido automático al anochecer

ESPECIFICACIONES

Panel solar: 4.2 V , 71 mA
2 Modos automáticos:
1 LED 1 lm / 2 LED's 22 lm
Duración de batería:
Alta intensidad 1.5 h, baja intensidad 12 h
Grado IP: 44
Temperatura de color: 6 500 K / Luz de día
Distancia de detección (Alcance): 5 m
Rango de detección: 90°



Caja máster: 12 un.

CODIGO	REF	MEDIDA/TIPO	UN.	PRECIO + IVA
17-05-058	46362	0.3 W / 22 lm	Pza. 1	

LUZ SOLAR LED
Con sensor de luz y movimiento



- Cuerpo y pantalla de policarbonato
- Brazo de acero en L (incluye tornillería)

ESPECIFICACIONES

Tiempo de vida: 35,000 h
Temperatura de color: 6,500 K / Luz de día
Tiempo de carga: 8 h
Tiempo de uso continuo: 12 h
Ángulo y distancia de detección: 160° / 3.5 m
Altura de instalación: 3 m
Grado IP: 65



Caja máster: 2 unidades

CODIGO	REF	MEDIDA/TIPO	UN.	PRECIO + IVA
17-05-068	46956	4 W / 400 lm	Pza. 1	

LUZ SOLAR LED
Sensor de luz y movimiento



- Cuerpo y pantalla de policarbonato
- Soporte de acero para ajustar luminario (incluye tornillería)

ESPECIFICACIONES

Tiempo de vida: 35,000 h
Temperatura de color: 6,500 K / Luz de día
Tiempo de carga: 8 h
Tiempo de uso continuo: 10 h
Ángulo y distancia de detección: 120° / 10 m
Altura de instalación: 3 a 6 m
Grado IP: 65



Caja máster: 2 unidades

CODIGO	REF	MEDIDA/TIPO	UN.	PRECIO + IVA
17-05-064	46959	40 W / 4000 lm	Pza. 1	

LUZ SOLAR LED
Con sensor de luz y movimiento



- Ahorra hasta 84% en el consumo de energía
- Paneles de ABS dirigibles y pantalla de policarbonato
- Incluye tornillería

ESPECIFICACIONES

Tiempo de vida: 30,000 h
Temperatura de color: 6,500 K
Alcance del sensor: 4 m
Grado IP: 65



Caja máster: 2 unidades

CODIGO	REF	MEDIDA/TIPO	UN.	PRECIO + IVA
17-05-061	49782	7 W / 700 lm	Pza. 1	

VELA LED CON SENSOR



Cuerpo fabricado en cera sólida

- Encendido y apagado automático con aplauso o soplando cerca de la vela
- Efecto de flama real color ámbar
- Duración de la batería en uso continuo: 190 h
- Utiliza 2 pilas AA incluidas

LED



CODIGO	REF	MEDIDA/TIPO	UN.	PRECIO + IVA
17-05-056	48411	8 x 7 cm	Pza. 4	

JUEGO MINI VELAS



6 unidades

- Efecto llama titilante color ámbar
- Duración de la batería uso continuo: 130 h
- Utiliza una pila CR2032 (incluida)

LED



CODIGO	REF	MEDIDA/TIPO	UN.	PRECIO + IVA
17-05-055	47867	3.7 x 1.8 cm	Jgo. 4	

MINI LÁMPARA FLEXIBLE



5 led, para puerto USB

- Para laptops, computadoras de escritorio, baterías de respaldo y tomas de corriente con entrada USB

LED

ESPECIFICACIONES:
 Color 6 Colores surtidos
 Consumo 1 W
 Tensión 5 V



CODIGO	REF	MEDIDA/TIPO	UN.	PRECIO + IVA
17-05-062	47869	17 x 2 cm	Pza. 12	

PROYECTOR DE ESTRELLAS



Luz de noche

- 3 Modos de iluminación: Luz de noche, movimiento 360° y proyector de estrellas

Batería o cable USB



Utiliza 3 pilas alcalinas AA No incluidas



CODIGO	REF	MEDIDA/TIPO	UN.	PRECIO + IVA
17-05-053	47866	13.8 x 12.6 cm	Pza. 4	

FIGURA GATO MULTICOLOR



Luz de noche

- Se activa al dar una palmada
- Modos de iluminación: 4 Colores fijos, transición automática de 7 colores

LED



CODIGO	REF	MEDIDA/TIPO	UN.	PRECIO + IVA
17-05-057	47869	13.2 x 9.5 cm	Pza. 2	

NUBE NEÓN



Luz de noche

- Cuerpo de silicón
- Luz color azul

LED



Batería o cable USB



Utiliza 3 pilas alcalinas AA No incluidas



CODIGO	REF	MEDIDA/TIPO	UN.	PRECIO + IVA
17-05-060	47868	30 x 18 cm	Pza. 4	

COPLA SOLDAR
Fabricada en cobre

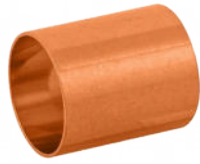

CODIGO	REF	MEDIDA/TIPO	UN.		PRECIO + IVA
17-06-500	47643	1/2"	Pza.	10	
17-06-502	47644	3/4"	Pza.	10	
17-06-504	47645	1"	Pza.	10	

TERMINAL HI
Fabricada en latón cobrizado



CODIGO	REF	MEDIDA/TIPO	UN.		PRECIO + IVA
17-06-512	47628	1/2"	Pza.	20	
17-06-514	47629	3/4"	Pza.	10	
17-06-516	47630	1"	Pza.	10	

CODO SOLDAR
Fabricada en cobre



CODIGO	REF	MEDIDA/TIPO	UN.		PRECIO + IVA
17-06-524	47631	1/2"	Pza.	10	
17-06-526	47632	3/4"	Pza.	10	
17-06-528	47633	1"	Pza.	10	

TAPA GORRO
Fabricada en cobre



CODIGO	REF	MEDIDA/TIPO	UN.		PRECIO + IVA
17-06-506	47640	1/2"	Pza.	10	
17-06-508	47641	3/4"	Pza.	10	
17-06-510	47642	1"	Pza.	10	

TERMINAL HE
Fabricada en latón cobrizado



CODIGO	REF	MEDIDA/TIPO	UN.		PRECIO + IVA
17-06-518	47625	1/2"	Pza.	20	
17-06-520	47626	3/4"	Pza.	10	
17-06-522	47627	1"	Pza.	10	

TEE SOLDAR
Fabricada en cobre



CODIGO	REF	MEDIDA/TIPO	UN.		PRECIO + IVA
17-06-530	47637	1/2"	Pza.	10	
17-06-532	47638	3/4"	Pza.	10	
17-06-534	47639	1"	Pza.	10	

CORTADOR DE TUBOS DE COBRE

Cuchillas de acero alta aleación

Incluyen cuchilla de repuesto



Removedor de rebabas

CODIGO	REF	MEDIDA/TIPO	UN.		PRECIO + IVA
17-06-001	12856	1.1/4"	Pza.	3	
17-06-003	12859	2"	Pza.	3	

MINI CORTADOR DE TUBO DE COBRE

Cuchillas de acero alta aleación

- Para lugares de difícil acceso
- Incluyen cuchilla de repuesto



CODIGO	REF	MEDIDA/TIPO	UN.		PRECIO + IVA
17-06-004	12850	1/8" a 5/8"	Pza.	6	
17-06-005	12851	1/8" a 1.1/8"	Pza.	6	

CORTADOR DE TUBOS DE PVC

Uso general

- Cuerpo aluminio
- Cuchilla de acero inoxidable



CODIGO	REF	MEDIDA/TIPO	UN.		PRECIO + IVA
17-06-009	12860	1.5/8"	Pza.	4	

JUEGO AVELLANADOR

Para aluminio, latón y cobre

- Para tubos de Ø 3/16" a 5/8"
- Para avellanados a 45°



CODIGO	REF	MEDIDA/TIPO	UN.		PRECIO + IVA
17-06-015	12868	-	Pza.	3	

LLAVE STILLSON

Cuerpo robusto de hierro dúctil

Mordazas ajustables de cromo molibdeno



CODIGO	REF	MEDIDA/TIPO	UN.		PRECIO + IVA
17-06-025	15836	10"	Pza.	3	
17-06-026	15837	12"	Pza.	3	
17-06-027	15838	14"	Pza.	3	
17-06-028	15839	18"	Pza.	2	
17-06-029	15840	24"	Pza.	2	

LLAVE PARA GASFITER

Acero al carbono

- Mordaza dentada activada por resorte, para máxima presión que evita el deslizamiento
- Capacidad 1/2" a 1"



CODIGO	REF	MEDIDA/TIPO	UN.		PRECIO + IVA
17-06-034	12874	12"	Pza.	6	

PRENSA DE YUGO

Para tubos de 2"

- Cuerpo de hierro nodular
- Mordazas dentadas de acero carbono



CODIGO	REF	MEDIDA/TIPO	UN.		PRECIO + IVA
17-06-070	17705	2"	Pza.	1	

SOLDADURA CON NÚCLEO DE RESINA

Para tubería hidráulica

ESPECIFICACIONES:
Diámetro: 3 mm
Punto de fusión: 225 °C

50% Estaño
50% Plomo



Empaque original: 4 piezas

CODIGO	REF	MEDIDA/TIPO	UN.	Pza.	PRECIO + IVA
17-06-102	14365	450g -9 m	Pza.	2	

MINI SOLDADURA SOLIDA

Para tubería hidráulica de cobre y hojas de metal

ESPECIFICACIONES:
Diámetro: 3 mm
Punto de fusión: 216 °C

50% Estaño
50% Plomo



CODIGO	REF	MEDIDA/TIPO	UN.	Pza.	PRECIO + IVA
17-06-103	13288	70g - 114 cm	Pza.	12	

PASTA PARA SOLDAR

Fabricada a base de petrolato



CODIGO	REF	MEDIDA/TIPO	UN.	Pza.	PRECIO + IVA
17-06-105	19337	60 gr	Pza.	12	

LÁPIZ PARA DESOLDAR

De succión

- Cuerpo de plástico y aluminio
- Punta antiadherente
- Botón para extracción



CODIGO	REF	MEDIDA/TIPO	UN.	Pza.	PRECIO + IVA
17-06-110	16923	19 x 2 cm	Pza.	4	

Soplete corto para lata de gas

Boquilla de acero, tubo y cuerpo de aluminio

- Ajuste preciso de flama
- Encendido manual



1/4 de vuelta

CODIGO	REF	MEDIDA/TIPO	UN.	Pza.	PRECIO + IVA
17-06-090	11923	Largo 179 mm	Pza.	5	

Soplete para lata roscada

Fabricada de latón

Difusor de calor para direccionar la flama y calentar más rápido el área de trabajo



CODIGO	REF	MEDIDA/TIPO	UN.	Pza.	PRECIO + IVA
17-06-092	11925	120 x 40 mm	Pza.	6	

Soplete para lata enc/eléctrico

Cuerpo de aluminio

- Perilla de ajuste de flama
- Encendido instantáneo
- Difusor de calor



1/4 de vuelta

CODIGO	REF	MEDIDA/TIPO	UN.	Pza.	PRECIO + IVA
17-06-094	11987	Largo 143 mm	Pza.	6	

VÁLVULA DE PIE PARA ESTANQUE



Fabricadas en latón para máxima duración

- Rejillas de acero inoxidable
- Uso en bombas de agua
- Evitan el retroceso de agua en la línea de succión de la bomba



CODIGO	REF	MEDIDA/TIPO	UN.	Pza.	PRECIO + IVA
17-06-390	49061	1/2"	Pza.	6	
17-06-392	49055	3/4"	Pza.	6	
17-06-394	49056	1"	Pza.	6	
17-06-396	49057	1.1/4"	Pza.	6	

ESCOBILLA WC

Con base

- Fibras onduladas
- Fabricado en polipropileno



CODIGO	REF	MEDIDA/TIPO	UN.	PRECIO + IVA
17-06-058	57029	-	Pza. 12	

SOPAPO PARA DESTAPAR



CODIGO	REF	MEDIDA/TIPO	UN.	PRECIO + IVA
17-06-059	55850	-	Pza. 3	

DESTAPADOR DE CAÑERÍA

Cable de acero con alma de nylon

Para tuberías hasta 2" (50 mm)



Empaque original: 4 unidades

CODIGO	REF	MEDIDA/TIPO	UN.	PRECIO + IVA
17-06-060	12279	7,6 m / Ø1.7mm	Pza. 1	

VÁLVULA DE LLENADO AJUSTABLE

Para WC

Altura ajustable de 7 1/2" a 10 1/2"

MEDIDAS:
Largo: 10 1/2"
Rosca: 15/16" - 14 NS



Caja máster: 24 piezas

CODIGO	REF	MEDIDA/TIPO	UN.	PRECIO + IVA
17-06-053	49338	-	Pza. 1	

VÁLVULA DE LLENADO CON FLOTADOR

Para WC

MEDIDAS:
Rosca 15/16"
Largo 8"



CODIGO	REF	MEDIDA/TIPO	UN.	PRECIO + IVA
17-06-052	49344	-	Pza. 4	

VÁLVULA DE DESCARGA

Para WC

MEDIDAS:
Rosca de 2"
Largo: 8.1/2"



CODIGO	REF	MEDIDA/TIPO	UN.	PRECIO + IVA
17-06-054	49345	-	Pza. 12	

SAPO DE PVC PARA WC

Con cadena plástica y gancho metálico



CODIGO	REF	MEDIDA/TIPO	UN.	PRECIO + IVA
17-06-056	49346	2"	Pza. 12	

JUEGO COMPLETO CON ACCESORIOS

Para WC

- INCLUYE:
- 1 Válvula de admisión
 - 1 Válvula de descarga
 - 1 Sapo de PVC con cadena
 - 1 Flotador
 - 1 Manilla de descarga cromada
 - 2 conectores con arandela y tuerca



CODIGO	REF	MEDIDA/TIPO	UN.	PRECIO + IVA
17-06-050	49342	-	Jgo. 4	

PASTILLA AROMATIZANTE Lavanda



- Aromatizan y desinfectan
- Cuentan con ganchos flexibles



Caja máster: 50 piezas

CODIGO	REF	MEDIDA/TIPO	UN.	PRECIO + IVA
17-06-044	57019	60g / Lavanda	Pza. 10	

PASTILLAS DESINFECTANTES

Juego 2 piezas



- Eliminan gérmenes y bacterias
- Previenen la formación de sarro
- Duran hasta 4 semanas



CODIGO	REF	MEDIDA/TIPO	UN.	PRECIO + IVA
17-06-046	57021	48g c/u	Jgo. 12	

LIQUIDO DESTAPACAÑO



- Ayuda a eliminar obstrucciones comunes como residuos de jabón, cabello, grasa y materia orgánica
- Previene la acumulación de residuos
- No daña las tuberías



Caja máster: 6 piezas

CODIGO	REF	MEDIDA/TIPO	UN.	PRECIO + IVA
17-06-048	56030	946 ml	Pza. 1	

REJILLA DESAGUE



Cuerpo ABS

Para instalar con tubo de PVC sanitario de 2" (50 mm), 3" (75 mm) y 4" (100 mm)



CODIGO	REF	MEDIDA/TIPO	UN.	PRECIO + IVA
17-06-400	49616	5"	Pza. 4	

REJILLA DESAGUE



Cuerpo polipropileno y acero inoxidable

- Resistente a la corrosión
- Ideal para desagües interiores y exteriores
- Diámetro de salida: 1.3/4" (45 mm)



CODIGO	REF	MEDIDA/TIPO	UN.	PRECIO + IVA
17-06-404	49425	3.3/4"	Pza. 4	

REJILLA DESAGUE CUADRADA



Cuerpo metálico, tapa acero inoxidable

- Ideal para desagües interiores y exteriores
- Sello hidráulico que impide el retorno de olores
- Diámetro de salida: 1 1/2" (38 mm)



CODIGO	REF	MEDIDA/TIPO	UN.	PRECIO + IVA
17-06-408	49349	4"	Pza. 4	

REJILLA DESAGUE LATERAL



Cuerpo ABS

- Ideal para baño y segundos pisos
- Para instalar con tubo de PVC sanitario de 2" (50 mm)



CODIGO	REF	MEDIDA/TIPO	UN.	PRECIO + IVA
17-06-402	49618	5"	Pza. 4	

REJILLA DESAGUE



Cuerpo metálico, tapa acero inoxidable

- Resistente a la corrosión
- Ideal para desagües interiores y exteriores
- Diámetro de salida: 1.3/4" (45 mm)



CODIGO	REF	MEDIDA/TIPO	UN.	PRECIO + IVA
17-06-406	49350	3.1/2"	Pza. 4	

REJILLA DESAGUE CUADRADA



Cuerpo metálico, tapa acero inoxidable

- Ideal para desagües interiores y exteriores
- Sello hidráulico que impide el retorno de olores
- Diámetro de salida: 1 7/8" (48 mm)



CODIGO	REF	MEDIDA/TIPO	UN.	PRECIO + IVA
17-06-410	46138	6"	Pza. 4	

MONOMANDO ABS

Incluye 2 flexibles y aireador

- Cartucho cerámico
- Fabricado en **ABS** antioxidante



Caja máster: 4 piezas

CODIGO	REF	MEDIDA/TIPO	UN.	PRECIO + IVA
17-06-300	49550	515 g	Pza. 1	

MONOMANDO LAVAPLATOS ABS

Incluye 2 flexibles

- Cartucho cerámico
- Fabricado en **ABS** antioxidante
- Incluye aireador



Caja máster: 4 piezas

CODIGO	REF	MEDIDA/TIPO	UN.	PRECIO + IVA
17-06-302	49551	485 g	Pza. 1	

COMB. LAVAPLATOS CUELLO CORTO ABS

Ideal para zonas costeras o de alta humedad

- Cuello de acero inoxidable
- Cartucho cerámico de suave apertura **CARCE-9**
- Incluye aireador
- Peso: 270 g



Caja máster: 4 piezas

CODIGO	REF	MEDIDA/TIPO	UN.	PRECIO + IVA
17-06-304	49289	8"	Pza. 1	

COMB. LAVAPLATOS CUELLO LARGO

Cuerpo de latón

- Cartucho cerámico de suave apertura **CARCE-1**
- Incluye aireador
- Peso 590 g



Caja máster: 4 piezas

CODIGO	REF	MEDIDA/TIPO	UN.	PRECIO + IVA
17-06-306	49239	8"	Pza. 1	

COMBINACIÓN LAVAMANOS

Base de acero inoxidable, manillas metálicas

- Cartucho cerámico de suave apertura **CARCE-1**
- Peso 490 g



Caja máster: 4 piezas

CODIGO	REF	MEDIDA/TIPO	UN.	PRECIO + IVA
17-06-310	49230	4"	Pza. 1	

REPUESTO CARTUCHOS CERÁMICOS

2 piezas

Para modelo 49289



CODIGO	REF	MEDIDA/TIPO	UN.	PRECIO + IVA
17-06-330	49417	CARCE-9	Pza. 6	

REPUESTO CARTUCHOS CERÁMICOS

2 piezas

Para modelos 49239 / 49238 / 49230



CODIGO	REF	MEDIDA/TIPO	UN.	PRECIO + IVA
17-06-332	49099	CARCE-1	Pza. 6	

JABONERA

Metálica



CODIGO	REF	MEDIDA/TIPO	UN.	Pza.	PRECIO + IVA
17-06-340	49611	71 g	4		

PORTA PAPEL HIGIÉNICO

Metálico



Barra de polipropileno



CODIGO	REF	MEDIDA/TIPO	UN.	Pza.	PRECIO + IVA
17-06-342	49612	91 g	4		

GANCHO DOBLE

Metálico



CODIGO	REF	MEDIDA/TIPO	UN.	Pza.	PRECIO + IVA
17-06-344	49609	43 g	4		

BARRA TOALLA

Metálica



CODIGO	REF	MEDIDA/TIPO	UN.	Pza.	PRECIO + IVA
17-06-346	49608	153 g	4		

PORTA PAPEL HIGIÉNICO

Barra de acero inoxidable



- Soporte metálico
- Incluye tornillería



CODIGO	REF	MEDIDA/TIPO	UN.	Pza.	PRECIO + IVA
17-06-370	49634	410 g	4		

GANCHO

Metálico



Incluye tornillería



CODIGO	REF	MEDIDA/TIPO	UN.	Pza.	PRECIO + IVA
17-06-372	49635	230 g	4		

TOALLERO ARGOLLA

Metálico



Incluye tornillería



CODIGO	REF	MEDIDA/TIPO	UN.	Pza.	PRECIO + IVA
17-06-374	49639	280 g	4		

TOALLERO BARRA

Barra de acero inoxidable



- Soporte metálico
- Incluye tornillería



CODIGO	REF	MEDIDA/TIPO	UN.	Pza.	PRECIO + IVA
17-06-376	49638	430 g	4		

SET DE BAÑO BASIC

5 piezas



- Fabricado en acero inoxidable

INCLUYE:

- 1 gancho doble
- 1 portarollo
- 1 portavasos cepillero
- 1 jabonera
- 1 toallero de barra de 60 cm



Caja máster: 2 Set

CODIGO	REF	MEDIDA/TIPO	UN.	Set	PRECIO + IVA
17-06-360	49255	410 g	1		

ORGANIZADOR DE BAÑO

Cubierta plástica



- Estructura de acero con cubierta de polietileno



Caja máster: 8 piezas

CODIGO	REF	MEDIDA/TIPO	UN.	Pza.	PRECIO + IVA
17-06-350	49975	50 x 25 cm	1		

BALANZA DE BAÑO

180 kg



- Ultra delgada
- Pantalla LCD de fácil lectura
- Resistente base de vidrio templado con 4 sensores de alta precisión

ESPECIFICACIONES:
Capacidad: 10 - 180 kg
Largo: 33 cm
Fondo: 30 cm
Grosor: 6 mm
Peso: 1.7 kg



Caja máster: 4 piezas

CODIGO	REF	MEDIDA/TIPO	UN.	Pza.	PRECIO + IVA
17-06-352	49910	Blanco	1		
17-06-354	48526	Transparente	1		

PESA DIGITAL PARA COCINA
Pantalla LCD, recipiente de vidrio

- Sensor de medición y precisión
- Indicador de sobrepeso (sobrecarga) "0-Ld"
- Función TARA, elimina el peso del recipiente
- Restablecimiento cero automático
- Apagado automático
- Indicador de batería baja
- Incluye 2 pilas AAA

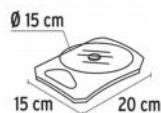

Caja máster: 2 piezas

CODIGO	REF	MEDIDA/TIPO	UN.	PRECIO + IVA
17-07-030	15160	5 kg	Pza. 1	

BALANZA RESORTE
Cubierta de aluminio

PRETUL®

- Medición en kg y lb
- Dinamómetro mecánico
- ganchos, cuerpo y resortes de acero



CODIGO	REF	MEDIDA/TIPO	UN.	PRECIO + IVA
17-07-010	21253	25 kg	Pza. 6	
17-07-012	21254	50 kg	Pza. 4	
17-07-014	21255	100 kg	Pza. 4	

PESA MECÁNICA COCINA
Con bandeja

PRETUL®

- Sistema de calibración manual
- Indicador de fácil lectura
- Carcasa plástica
- Unidad de medida: g
- Incluyen bandeja: 154 x 49 x 148 mm



Caja máster: 2 piezas

CODIGO	REF	MEDIDA/TIPO	UN.	PRECIO + IVA
17-07-026	29973	5 kg	Pza. 1	

BISAGRA PARA MUEBLES
Cobertura completa. Bolsa 2 piezas



- Fabricadas en acero
- Ideales para gabinetes
- Cierre automático
- Incluyen tornillería de instalación
- Perforación 26 mm



Incluye



CODIGO	REF	MEDIDA/TIPO	UN.		PRECIO + IVA
17-08-020	43156	95°	Par	6	
17-08-021	43157	110°	Par	6	
17-08-050	43163	165°	Par	4	

BISAGRA PARA MUEBLES
Cobertura media. Bolsa 2 piezas

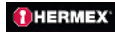

- Fabricadas en acero
- Ideales para gabinetes
- Cierre automático
- Incluyen tornillería de instalación
- Perforación 26 mm



Incluye



CODIGO	REF	MEDIDA/TIPO	UN.		PRECIO + IVA
17-08-023	43160	95°	Par	6	
17-08-028	43161	110°	Par	6	

BISAGRA PARA MUEBLES
Cobertura interna. Bolsa 2 piezas



- Fabricadas en acero
- Ideales para gabinetes
- Cierre automático
- Incluyen tornillería de instalación
- Perforación 26 mm



Incluye



CODIGO	REF	MEDIDA/TIPO	UN.		PRECIO + IVA
17-08-027	43159	110°	Par	6	

BISAGRA PARA MUEBLES
Brazo corto, cob. completa. Bolsa 2 piezas



- Fabricadas en acero con acabado niquelado
- Cierre automático
- Instalación oculta para gabinetes
- Uso en carpintería y en la industria mueblera



Incluye



CODIGO	REF	MEDIDA/TIPO	UN.		PRECIO + IVA
17-08-030	43164	90°	Par	4	

PISTÓN A GAS
Cilindro de acero



Incluye tornillería



Para instalación derecha o izquierda



Caja máster: 25 un.

CODIGO	REF	MEDIDA/TIPO	UN.		PRECIO + IVA
17-08-150	42002	60n-6 Kg.	Pza.	5	
17-08-152	42003	100n-10 Kg.	Pza.	5	
17-08-154	42004	120n- 12 Kg.	Pza.	5	

ESCUADRA REFORZADA
Color blanco



Espesor: 4 mm



CODIGO	REF	MEDIDA/TIPO	UN.		PRECIO + IVA
17-08-010	44670	8 x 12"	Pza.	10	
17-08-012	44671	10 x 16"	Pza.	10	
17-08-014	44672	13 x 20"	Pza.	10	

BISAGRA CUADRADA
Acero latonado



Fabricadas en acero con acabado latonado pulido espejo



Incluyen tornillería



CODIGO	REF	MEDIDA/TIPO	UN.		PRECIO + IVA
17-08-052	28800	3"	Pza.	20	
17-08-054	23685	3.1/2"	Pza.	10	
17-08-056	23686	4"	Pza.	10	

BISAGRA RECTANGULAR
Acero latonado



Incluyen tornillería



CODIGO	REF	MEDIDA/TIPO	UN.		PRECIO + IVA
17-08-040	43192	1"	Pza.	20	
17-08-042	43193	1.1/2"	Pza.	20	
17-08-044	43194	2"	Pza.	20	
17-08-046	43195	2.1/2"	Pza.	20	
17-08-047	43196	3"	Pza.	20	
17-08-048	43197	3.1/2"	Pza.	20	
17-08-049	43198	4"	Pza.	20	

BISAGRA DOBLE ACCIÓN
Acabado latonado



Incluyen tornillería



Permiten que la puerta se abra en ambos sentidos

Caja máster: 6 piezas

CODIGO	REF	MEDIDA/TIPO	UN.		PRECIO + IVA
17-08-060	43182	3"	Pza.	1	

GANCHOS TIPO PERCHERO Simple



Largo: 4 cm



Incluyen tornillería

CODIGO	REF	MEDIDA/TIPO	UN.	PRECIO + IVA
17-08-220	48350	Latón brillante	Pza. 12	
17-08-222	48351	Latón antiguo	Pza. 12	
17-08-224	48353	Níquel satinado	Pza. 12	

GANCHOS TIPO PERCHERO Dobles



Largo: 7 cm



Incluyen tornillería

CODIGO	REF	MEDIDA/TIPO	UN.	PRECIO + IVA
17-08-200	48356	Latón brillante	Pza. 12	
17-08-202	48357	Latón antiguo	Pza. 12	
17-08-204	43911	Níquel satinado	Pza. 12	

GANCHOS TIPO PERCHERO Sombrero y abrigo



Largo: 7 cm



Incluyen tornillería

CODIGO	REF	MEDIDA/TIPO	UN.	PRECIO + IVA
17-08-212	48354	Latón brillante	Pza. 12	
17-08-210	48355	Latón antiguo	Pza. 12	
17-08-214	48355	Níquel satinado	Pza. 12	

MANILLA CUADRADA EMBUTIR
Para cajones de madera y metal



- Fabricadas en acero inoxidable
- incluye tornillería

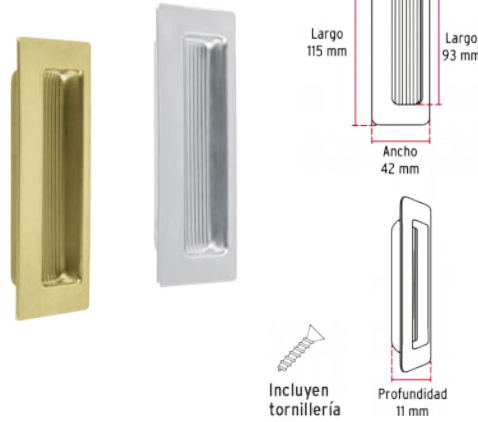

CODIGO	REF	MEDIDA/TIPO	UN.	PRECIO + IVA
17-08-700	48991	Latón brillante	Pza. 10	
17-08-702	46238	Cromada	Pza. 10	

MANILLA OVALADA EMBUTIR
Para cajones de madera y metal



- Fabricadas en acero inoxidable
- incluye tornillería

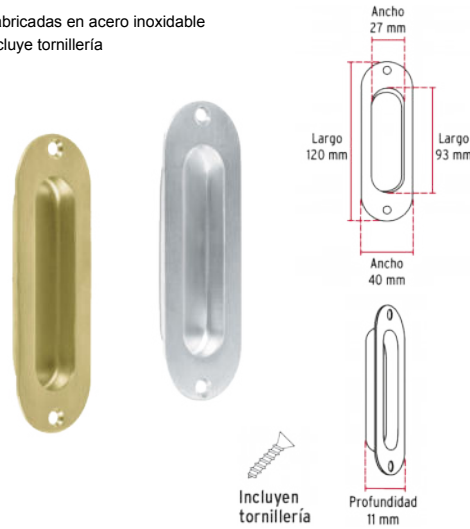

CODIGO	REF	MEDIDA/TIPO	UN.	PRECIO + IVA
17-08-704	48992	Latón brillante	Pza. 10	
17-08-706	46239	Cromada	Pza. 10	

MANILLA CIRCULAR EMBUTIR
Para cajones de madera y metal



- Fabricadas en acero inoxidable
- incluye tornillería

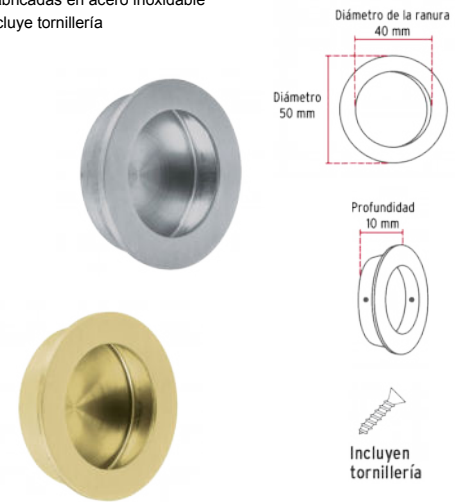

CODIGO	REF	MEDIDA/TIPO	UN.	PRECIO + IVA
17-08-708	48995	Latón brillante	Pza. 10	
17-08-710	48999	Cromada	Pza. 10	

BARRA PARA CLOSET OVALADA
Fabricado en acero con acabado cromo



Ideal para clósets, guardarropas y probadores

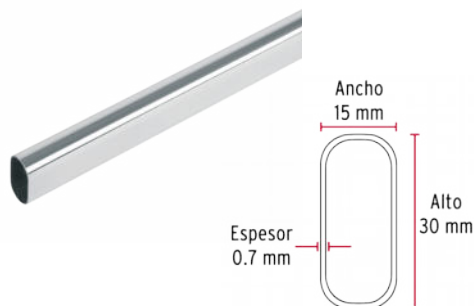

CODIGO	REF	MEDIDA/TIPO	UN.	Pza.	PRECIO + IVA
17-08-400	48977	3 m	10		

SOPORTE PARA BARRA CLOSET OVALADO
Acabado niquelado

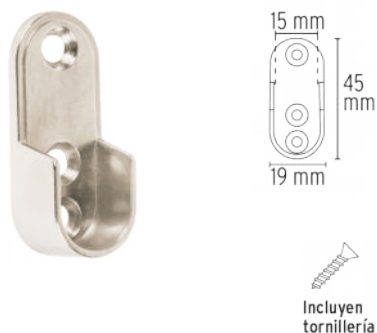

CODIGO	REF	MEDIDA/TIPO	UN.	Pza.	PRECIO + IVA
17-08-500	48978	-	10		

SOPORTE CENTRAL PARA BARRA CLOSET
Acabado niquelado

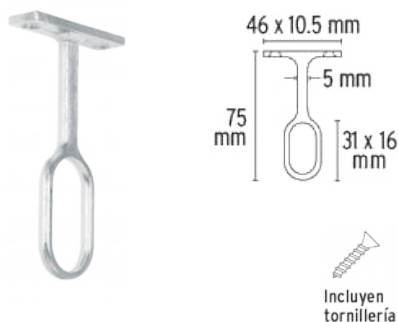

CODIGO	REF	MEDIDA/TIPO	UN.	Pza.	PRECIO + IVA
17-08-506	48979	-	10		

RIEL SUPERIOR "JJ"
Para puerta corredera



- Fabricados en aluminio
- Para puertas de clóset de hasta 45 kg

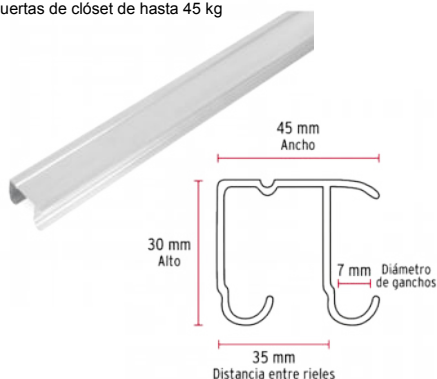

CODIGO	REF	MEDIDA/TIPO	UN.	Pza.	PRECIO + IVA
17-08-600	48972	2 m	10		
17-08-602	48973	3 m	10		

CORREDERAS P/RIEL SUPERIOR
Para clóset de 2 puertas con espesor 15 a 30 mm



- Ruedas de nylon y cuerpo de acero con perforaciones para una mejor regulación de la puerta

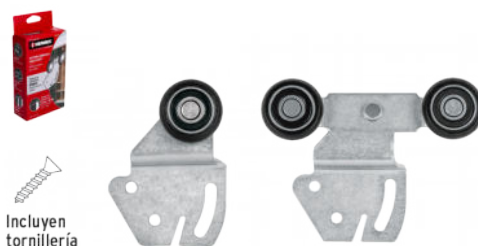

Caja máster: 10 juegos

CODIGO	REF	MEDIDA/TIPO	UN.	Jgo.	PRECIO + IVA
17-08-604	48970	Simple / 30 kg	1		
17-08-605	48971	Doble / 45 kg	1		

CIERRAPUERTAS HIDRÁULICO



- Fabricado en acero
- Apertura hasta 160°
- Puertas de 40 a 80 kg
- 3 niveles de ajuste



Caja máster: 4 unidades

CODIGO	REF	MEDIDA/TIPO	UN.	Pza.	PRECIO + IVA
17-08-001	43606	-	1		

TOPE DE HULE PARA PUERTA
Base antideslizante



CODIGO	REF	MEDIDA/TIPO	UN.	Pza.	PRECIO + IVA
17-22-230	40165	12 x 4 x 2.5 cm	12		

NÚMEROS DE LATÓN 4"
Resistentes a la intemperie



CODIGO	REF	MEDIDA/TIPO	UN.	Pza.	PRECIO + IVA
17-08-300	43678	0	6		
17-08-301	43679	1	6		
17-08-302	43680	2	6		
17-08-303	43681	3	6		
17-08-304	43682	4	6		
17-08-305	43683	5	6		
17-08-306	43684	6	6		
17-08-307	43685	7	6		
17-08-308	43686	8	6		
17-08-309	43687	9	6		

CHINCHES

Caja 100 unidades, colores surtidos



CODIGO	REF	MEDIDA/TIPO	UN.	PRECIO + IVA
17-08-170	41250	8.5 x 10 mm	Cien	10

ENGRAPADORA ET-21

Para grapas de 1/4"- 5/16"- 3/8"

INCLUYE:
200 grapas de 5/16"



Grapas



Caja máster: 4 unidades

CODIGO	REF	MEDIDA/TIPO	UN.	PRECIO + IVA
17-08-102	17963	-	Pza.	1

ENGRAPADORA Y CLAVADORA ET-50

Para clavos de 5/8" y grapas de 1/4" a 9/16"

INCLUYE:
500 grapas de 5/16"
y 500 grapas de 1/2"



Grapas



Clavos



Caja máster: 4 unidades

CODIGO	REF	MEDIDA/TIPO	UN.	PRECIO + IVA
17-08-100	17964	-	Pza.	1

GRAPAS PARA ET-21

Caja 1000 unidades

Ancho: 11.3 mm
Espesor: 0.5 mm

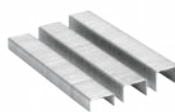

CODIGO	REF	MEDIDA/TIPO	UN.	PRECIO + IVA
17-08-114	17970	1/4"	Cja.	10
17-08-116	17971	5/16"	Cja.	10
17-08-118	17982	3/8"	Cja.	10

GRAPAS PARA ET-50

Caja 1000 unidades

Ancho: 10.7 mm
Espesor: 0.6 mm

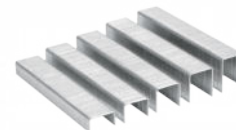

CODIGO	REF	MEDIDA/TIPO	UN.	PRECIO + IVA
17-08-104	17965	1/4"	Cja.	10
17-08-106	17966	5/16"	Cja.	10
17-08-108	17967	3/8"	Cja.	10
17-08-110	17968	1/2"	Cja.	10
17-08-112	17969	9/16"	Cja.	10

CLAVOS PARA ET-50

Calibre 18, caja 5000 unidades

Este artículo también lo puede encontrar en la sección de acc. neumáticos

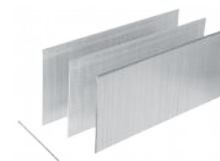

CODIGO	REF	MEDIDA/TIPO	UN.	PRECIO + IVA
17-29-111	18261	5/8"	Cja.	1

CARRO DE CARGA "YEGUA"

Capacidad 100 kg

- Tubos de acero cédula 30
- Soleras de acero
- Plataforma con 3 refuerzos
- Ruedas de hule solido



MEDIDAS:

Altura: 90 cm
Ancho: 33 cm
Base: 33 x 28 cm
Diámetro tubo: 1"
Diámetro del eje: 5/8"
Diámetro ruedas: 6"
Peso: 9 kg



CODIGO	REF	MEDIDA/TIPO	UN.	Pza.	PRECIO + IVA
17-08-090	44475	90 cm	1	1	

CARRO DE CARGA "YEGUA"

Capacidad 200 kg

- Tubos de acero cédula 30
- Soleras de acero
- Plataforma con 3 refuerzos
- Ruedas de hule solido



MEDIDAS:

Altura: 110 cm
Ancho: 44 cm
Base: 44 x 38 cm
Diámetro tubo: 1"
Diámetro del eje: 5/8"
Diámetro ruedas: 7"
Peso: 13 kg



CODIGO	REF	MEDIDA/TIPO	UN.	Pza.	PRECIO + IVA
17-08-092	44476	110 cm	1	1	

CARRO DE CARGA "YEGUA"

Capacidad 300 kg

- Tubos de acero cédula 30
- Soleras de acero
- Plataforma con 3 refuerzos
- Doble rodamiento en cada rueda
- Ruedas de hule solido



MEDIDAS:

Altura: 130 cm
Ancho: 44 cm
Base: 44 x 38 cm
Diámetro tubo: 1"
Diámetro del eje: 5/8"
Diámetro ruedas: 8"
Peso: 16 kg



CODIGO	REF	MEDIDA/TIPO	UN.	Pza.	PRECIO + IVA
17-08-094	44477	130 cm	1	1	

CARRO DE CARGA 2 POSICIONES

Capacidad 385 kg

- Mango ajustable para uso como plataforma
- Tubos de acero calibre 19
- 2 ruedas giratorias y 2 ruedas neumáticas con doble rodamiento en cada una



MEDIDAS:

Altura: 153 cm
Ancho: 50 cm
Base: 35 x 23 cm
Diámetro tubo lateral: 1.1/4"
Diámetro del eje: 5/8"
Diámetro ruedas neumáticas: 10"
Peso: 13 kg



Ajustable a posición tipo plataforma de carga

CODIGO	REF	MEDIDA/TIPO	UN.	Pza.	PRECIO + IVA
17-08-095	42710	153 cm	1	1	

CARRO DE CARGA PLEGABLE

PRETUL®

Tipo plataforma

- Mango tubular de acero de 1"
- Dimensiones de la plataforma: 90 x 61 cm
- Peso: 13.3 kg



CODIGO	REF	MEDIDA/TIPO	UN.	Pza.	PRECIO + IVA
17-08-097	49907	300 Kg	1	1	

RUEDA CON SOPORTE GIRATORIO

Fabricada en polipropileno con placa de acero



CODIGO	REF	MEDIDA/TIPO	UN.	Pza.	PRECIO + IVA
17-08-084	45089	-	2	2	

RUEDA PARA CARRO DE CARGA

PRETUL®

Fabricada en caucho anti-pinchaduras

Diámetro del eje: 5/8"



CODIGO	REF	MEDIDA/TIPO	UN.	Pza.	PRECIO + IVA
17-08-069	45476	4"	4	4	
17-08-070	45478	5"	4	4	
17-08-071	45481	6"	4	4	
17-08-072	45482	7"	4	4	

Con doble rodamiento

CODIGO	REF	MEDIDA/TIPO	UN.	Pza.	PRECIO + IVA
17-08-080	45485	8"	4	4	
17-08-081	45487	9"	4	4	
17-08-082	45035	10"	4	4	

BOMBA PARA INFLAR
Acabado en acero inoxidable

INCLUYE:
Válvulas para inflables y balones

Base Abatible

ESPECIFICACIONES:
Longitud: 23"
Diámetro: 1.3/4"
Peso: 800 g



CODIGO	REF	MEDIDA/TIPO	UN.	PRECIO + IVA
17-36-001	14863	100 PSI	Pza. 5	

MINI BOMBA PARA INFLAR
Cilindro de aluminio ligero

Base de pedal abatible

ESPECIFICACIONES:
Longitud: 11"
Diámetro: 1"
Peso: 175 g

Incluye soporte para bicicleta



CODIGO	REF	MEDIDA/TIPO	UN.	PRECIO + IVA
17-36-003	13790	60 PSI	Pza. 6	

BOMBA DE PEDAL
Diseño compacto

- Cuerpo de polipropileno
- Compartimento para almacenar válvulas y pedal antiderrapante
- Base de pedal abatible

ESPECIFICACIONES:
Longitud: 9"
Diámetro: 1.3/4"



CODIGO	REF	MEDIDA/TIPO	UN.	PRECIO + IVA
17-36-002	101667	60 PSI	Pza. 6	

BOMBA MANUAL
Cuerpo metálico

INCLUYE:
Válvulas para inflables y balones

ESPECIFICACIONES:
Longitud: 24"
Diámetro: 1.1/4"
Peso: 640 g



CODIGO	REF	MEDIDA/TIPO	UN.	PRECIO + IVA
17-36-006	21690	80 PSI	Pza. 6	

PRETUL®

MINI BOMBA PARA INFLAR ABATIBLE
Cuerpo ligero de aluminio con diseño compacto

- Manguera reversible para válvula americana y europea
- Compartimento para guardar manguera (incluida)
- Soporte para montarla al cuadro de la bicicleta

ESPECIFICACIONES:
Longitud: 19 cm (7")
Diámetro: 22 mm (7/8")



Compartimento para manguera

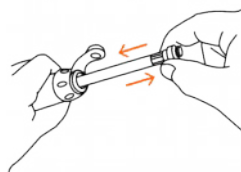

Soporte para bicicleta



CODIGO	REF	MEDIDA/TIPO	UN.	PRECIO + IVA
17-36-004	11997	75 PSI	Pza. 6	

BOMBA DE PEDAL
1 pistón y válvula para balón

PRETUL®

- Cuerpo de acero
- Pedal antideslizante

INCLUYE:
Válvulas para inflables y balones

ESPECIFICACIONES:
Diámetro: 2"
Peso: 650 g



CODIGO	REF	MEDIDA/TIPO	UN.	PRECIO + IVA
17-36-005	21693	58 PSI	Pza. 4	

VÁLVULA PARA INFLAR BALONES **PRETUL®**
Bolsa con 5 unidades

- Aguja fabricada de acero inoxidable
- Salida de aire



CODIGO	REF	MEDIDA/TIPO	UN.	PRECIO + IVA
17-36-014	26065	-	Bol5 10	

LUZ TRASERA BICICLETA 9 Led

- Soporte de polipropileno para tubos de 2,2 a 3 cm
- Luz roja fija y 6 diferentes destellos de luz

ESPECIFICACIONES:
Leds: **9 led** lente plano
Largo: **7,5 cm**
Duración: **45 h**
Incluye **2 pilas AAA**



CODIGO	REF	MEDIDA/TIPO	UN.	Pza.	PRECIO + IVA
17-36-010	16797	-	Pza.	6	

LUZ DELANTERA BICICLETA Led con tecnología de alta potencia

- Cuerpo de aluminio
- Soporte de polipropileno para tubos de 2,2 a 3 cm
- Sometible a salpicaduras de agua
- Haz de luz ajustable

ESPECIFICACIONES:
Leds: **1 Led** de alta potencia
Potencia: **100 lm**
Distancia de alcance: **200 m**
Modalidades: luz **alta, baja e intermitente**
Duración: Luz alta **5 h** / luz baja **24 h**
Largo: **11,5 cm**
Incluye **3 pilas alcalinas AAA**

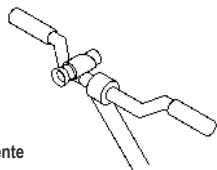

CODIGO	REF	MEDIDA/TIPO	UN.	Pza.	PRECIO + IVA
17-36-012	16796	100 lm	Pza.	1	

LINTERNA DE CABEZA OUTDOOR 1 led

ESPECIFICACIONES:
Cantidad de led: **1 led** alta intensidad
Luminosidad: **150 lm**
Duración: **11 h** en modo bajo
Distancia máxima **20 m**
Modo iluminación: **alto, bajo e intermitente**
Pilas: **3 AAA (no incluidas)**
Material: **ABS**



Caja máster: 6 piezas

CODIGO	REF	MEDIDA/TIPO	UN.	Pza.	PRECIO + IVA
17-10-006	11751	150 lm	Pza.	1	

LINTERNA ALUMINIO LED 850 lúmenes

ESPECIFICACIONES

Luminosidad: **850 lm** (alto), **450 lm** (bajo)
LED: **1 LED CREE** Alta luminosidad y alcance
Duración de carga de la batería: **25 horas** (alto), **40 horas** (bajo)
Modos de iluminación: (3) **Alto, bajo e intermitente**
Pilas: **3 Tipo D** (incluidas)
Grado IP: **X4**
Material del cuerpo: **Aluminio**



Caja máster: 2 piezas

CODIGO	REF	MEDIDA/TIPO	UN.	Pza.	PRECIO + IVA
17-10-008	18814	27 cm	Pza.	-	

LINTERNA ALUMINIO LED 235 lúmenes

ESPECIFICACIONES

Luminosidad: **235 lm** (alto), **100 lm** (bajo)
LED: **1 LED CREE** Alta luminosidad y alcance
Duración de carga de la batería: **3.5 horas** (alto), **5.5 horas** (bajo)
Modos de iluminación: (3) **Alto, bajo e intermitente**
Pilas: **2 AA** de (incluidas)
Grado IP: **X4**
Material del cuerpo: **Aluminio**



Caja máster: 6 piezas

CODIGO	REF	MEDIDA/TIPO	UN.	Pza.	PRECIO + IVA
17-10-010	18800	17 cm	Pza.	-	

LINTERNA ALUMINIO LED, RECARGABLE 650 lúmenes

ESPECIFICACIONES

Luminosidad: **650 lm** (alto), **330 lm** (bajo)
LED: **1 LED** Alta intensidad
Duración de carga de la batería: **3.5 horas** (alto), **10 horas** (bajo)
Modos de iluminación: (3) **Alto, bajo e intermitente**
Pilas: **2 (ion litio, incluidas)**
Grado IP: **X5**
Material del cuerpo: **Aluminio**



Caja máster: 6 piezas

CODIGO	REF	MEDIDA/TIPO	UN.	Pza.	PRECIO + IVA
17-10-012	101330	22 cm	Pza.	-	

LINTERNA ALUMINIO LED, TIPO FAROL 600 lúmenes

ESPECIFICACIONES

Luminosidad: **600 lm**
Duración de carga de la batería: **36 h**
Material del cuerpo: **ABS** resistente a impactos
Grado IP: **X4**
Empaque individual: **Caja**



Caja máster: 2 piezas

CODIGO	REF	MEDIDA/TIPO	UN.	Pza.	PRECIO + IVA
17-10-014	10760	23 cm x 11 cm	Pza.	-	

ESCOBA METAL JARDÍN
20 dientes, cabeza curva

ESPECIFICACIONES:
Con mango 48"
Ancho 17"
Calibre 20



CODIGO	REF	MEDIDA/TIPO	UN.	PRECIO + IVA
17-11-027	21431	20 dts.	Pza. 6	

PRETUL® ESCOBA JARDÍN PLÁSTICA
26 dientes, rígida

ESPECIFICACIONES:
Con mango 48"



CODIGO	REF	MEDIDA/TIPO	UN.	PRECIO + IVA
17-11-040	19786	22" / 22 dts.	Pza. 6	
17-11-042	19788	24" / 26 dts.	Pza. 6	

ESCOBA METAL JARDÍN
22 dientes, cabeza curva

ESPECIFICACIONES:
Mango 48"
Ancho 20"
Calibre 20



CODIGO	REF	MEDIDA/TIPO	UN.	PRECIO + IVA
17-11-035	14322	22 dts.	Pza. 6	

ESCOBA METAL JARDÍN
22 dientes, redondos

ESPECIFICACIONES:
Con mango 48"
Ancho 18"
Calibre 12



CODIGO	REF	MEDIDA/TIPO	UN.	PRECIO + IVA
17-11-037	14324	22 dts.	Pza. 6	

ESCOBA JARDÍN PLÁSTICA
22 dientes, flexible

ESPECIFICACIONES:
Con mango 48"
Ancho 22"



CODIGO	REF	MEDIDA/TIPO	UN.	PRECIO + IVA
17-11-044	19785	22 dts.	Pza. 6	

ESCOBA METAL JARDÍN
22 dientes, cabeza recta

ESPECIFICACIONES:
Mango 48"
Ancho 22"
Calibre 20



CODIGO	REF	MEDIDA/TIPO	UN.	PRECIO + IVA
17-11-031	14328	22 dts.	Pza. 6	

ESCOBA METAL JARDÍN
24 dientes, cabeza recta

ESPECIFICACIONES:
Con mango: 54"
Ancho: 23"
Calibre: 18"



CODIGO	REF	MEDIDA/TIPO	UN.		PRECIO + IVA
17-11-032	14342	24 dts.	Pza.	6	

RASTRILLO RECTO
16 dientes, mango de 60"

ESPECIFICACIONES:
Ancho 16.1/2"
Troquelado de 1/4" de espesor



CODIGO	REF	MEDIDA/TIPO	UN.		PRECIO + IVA
17-11-090	17880	16 dts.	Pza.	3	

RASTRILLO JARDINERO
14 dientes, mango de 48"

PRETUL®

ESPECIFICACIONES:
Ancho 13.1/2"
Troquelado de 1/4" de espesor



CODIGO	REF	MEDIDA/TIPO	UN.		PRECIO + IVA
17-11-094	25054	14 dts.	Pza.	3	

ESCOBA METAL/PLAST. JARDÍN
22 dientes, cabeza recta

ESPECIFICACIONES:
Con mango 48"
Ancho 22"
Calibre 18



CODIGO	REF	MEDIDA/TIPO	UN.		PRECIO + IVA
17-11-033	14332	22 dts.	Pza.	6	

RASTRILLO JARDINERO
16 dientes, mango de 54"

ESPECIFICACIONES:
Ancho 16.1/2"
Troquelado de 1/4" de espesor



CODIGO	REF	MEDIDA/TIPO	UN.		PRECIO + IVA
17-11-092	17882	16 dts.	Pza.	3	

NYLON PARA ORILLADORA REDONDO

Envase blister



CODIGO REF MEDIDA/TIPO UN. PRECIO + IVA

12 a 15 m

17-11-150	17605	1,6mm x 15m	Rollo	6	
17-11-152	17606	2 mm x 15m	Rollo	6	
17-11-153	17607	2,4mm x 12m	Rollo	6	
17-11-154	17629	2,7mm x 12m	Rollo	6	



48 a 120 m

17-11-252	17608	2mm / 120m	Rollo	4	
17-11-253	17609	2,4mm / 78m	Rollo	4	
17-11-254	17610	2,7mm / 63m	Rollo	4	
17-11-256	17630	3.3mm / 48m	Rollo	4	

CINTA DE AMARRE

Con alma de metal 30 m

- Impermeable
- Incluye cortador



CODIGO REF MEDIDA/TIPO UN. PRECIO + IVA

17-11-100	12322	30 m	Pza.	12	
-----------	-----------------------	------	------	----	--

SERRUCHO PODAR

Mango madera

- Hoja de acero SK5 resistente al desgaste, curva para cortes rápidos
- Barrenos que ayudan a expulsar el material durante el corte



DIENTES CON TRIPLE FILO

CODIGO REF MEDIDA/TIPO UN. PRECIO + IVA

17-11-103	18171	12" / 6 dpp	Pza.	3	
-----------	-----------------------	-------------	------	---	--

SERRUCHO PODAR

Mango grip

- Hoja de acero SK5 resistente al desgaste, curva para cortes rápidos
- Barrenos que ayudan a expulsar el material durante el corte
- Gancho tope para facilitar los cortes



Adaptable a mango telescópico

CODIGO REF MEDIDA/TIPO UN. PRECIO + IVA

17-11-105	18179	16" / 5 dpp	Pza.	6	
-----------	-----------------------	-------------	------	---	--

MANGO TELESCÓPICO

Fibra de vidrio

Este artículo también lo puede encontrar en la sección de agricultura

- Par cortador de ramas altas, recolector de fruta y sERRUCHO de podar mango grip
- Extensión de 1.91 a 3.62 m

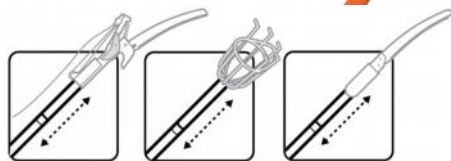

CODIGO REF MEDIDA/TIPO UN. PRECIO + IVA

17-37-025	16012	-	Pza.	3	
-----------	-----------------------	---	------	---	--

ARCO JARDINERO TUBULAR

Para corte y poda de árboles y arbustos

- Dientes afilados y templados
- Seguenta de acero SK5

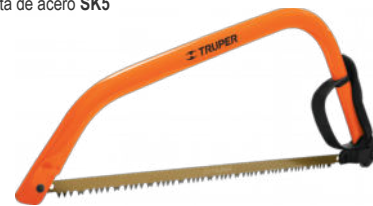

CODIGO REF MEDIDA/TIPO UN. PRECIO + IVA

17-11-001	10254	21"	Pza.	3	
-----------	-----------------------	-----	------	---	--

17-11-004	10258	24"	Pza.	3	
-----------	-----------------------	-----	------	---	--

17-11-007	10260	30"	Pza.	3	
-----------	-----------------------	-----	------	---	--

Hoja de repuesto



CODIGO REF MEDIDA/TIPO UN. PRECIO + IVA

17-11-013	10266	21"	Pza.	12	
-----------	-----------------------	-----	------	----	--

17-11-016	10270	24"	Pza.	12	
-----------	-----------------------	-----	------	----	--

17-11-019	10271	30"	Pza.	12	
-----------	-----------------------	-----	------	----	--

CARRETILLA JARDINERA

Ideal para parques y grandes jardines

- Concha plástica y bastidores de 2"
- Llantas neumáticas ligeras de 16" x 4"
- Presión de inflado 20 a 25 PSI



CODIGO REF MEDIDA/TIPO UN. PRECIO + IVA

17-11-087	19810	175 L	Pza.	1	
-----------	-----------------------	-------	------	---	--

JGO DE HERRAMIENTAS JARDÍN PRETUL®

3 piezas, fabricado en plástico

INCLUYE:
Cuchara, trasplantador y cultivador



Caja máster: 36 juegos

CODIGO	REF	MEDIDA/TIPO	UN.	PRECIO + IVA
17-11-080	21709	Mango 5"	Jgo. 6	

JUEGO DE HERRAMIENTAS JARDÍN

4 piezas, mango madera

Orificio para colgar
Trasplantador con medición de profundidad



INCLUYE:
Cuchara, trasplantador, cultivador y biello

Caja máster: 6 Juegos

CODIGO	REF	MEDIDA/TIPO	UN.	PRECIO + IVA
17-11-077	15030	Mango 6"	Jgo. 1	

JUEGO HERRAMIENTAS JARDÍN

4 piezas, mango largo madera

- Orificio para colgar
- Trasplantador con medición de profundidad



INCLUYE:
Cuchara, trasplantador, cultivador y azadón

Caja máster: 6 Juegos

CODIGO	REF	MEDIDA/TIPO	UN.	PRECIO + IVA
17-11-078	15040	Mango 15"	Jgo. 1	

HERRAMIENTAS JARDÍN NIÑOS

Mango madera



CODIGO	REF	MEDIDA/TIPO	UN.	PRECIO + IVA
17-11-110	17239	Pala redonda 30"	Pza. 6	
17-11-112	19712	Pala Cuadrada 30"	Pza. 6	
17-11-114	14346	Escoba 42"	Pza. 6	

FUMIGADOR DOMÉSTICO

Boquilla de latón regulable

- Diseño reforzado
- Boquilla latón



CODIGO	REF	MEDIDA/TIPO	UN.	PRECIO + IVA
17-11-060	10929	1 L	Pza. 4	
17-11-062	10235	2 L	Pza. 4	

ATOMIZADOR
Boquilla regulable



- Sello antifugas
- Gatillo suave que reduce fatiga



Caja máster: 48 un.

CODIGO	REF	MEDIDA/TIPO	UN.	PRECIO + IVA
17-11-065	55937	1/2 L	Pza. 12	
17-11-067	55938	1 L	Pza. 12	

PALA ANCHA JARDÍN

Mango madera



CODIGO	REF	MEDIDA/TIPO	UN.	PRECIO + IVA
17-11-070	15020	Mango 6"	Pza. 6	

BIELLO 3 DIENTES

Mango madera



CODIGO	REF	MEDIDA/TIPO	UN.	PRECIO + IVA
17-11-072	15026	Mango 6"	Pza. 6	

TIJERA PODAR

Cuchillas de acero SK5



Mod. T-68

CODIGO	REF	MEDIDA/TIPO	UN.	PRECIO + IVA
17-11-117	18463	8"	Pza. 3	

TIJERA PODAR CURVA

Cuerpo de aluminio

- Cuchillas de acero SK5
- Con muesca para cortar alambre



Mod. T-45

CODIGO	REF	MEDIDA/TIPO	UN.	PRECIO + IVA
17-11-120	18453	8"	Pza. 3	

TIJERA PODAR FINA

Cuchillas en acero templado SAE 1050



Mod. T-20

CODIGO	REF	MEDIDA/TIPO	UN.	PRECIO + IVA
17-11-125	18456	6"	Pza. 3	

TIJERA PODAR CURVA

Cuchillas en acero templado SAE 1050



Mod. T-24

CODIGO	REF	MEDIDA/TIPO	UN.	PRECIO + IVA
17-11-126	18457	8"	Pza. 3	

TIJERA PARA PASTO

3 posiciones de corte

- Ideal para darle forma a los bordes en césped
- Cuchillas de acero SK5
- Uso con una mano



CODIGO	REF	MEDIDA/TIPO	UN.	PRECIO + IVA
17-11-113	18452	13"	Pza. 3	

TIJERA PODAR 2 MANOS

Mangos de polímero alto impacto

Con perilla de ajuste

ESPECIFICACIONES

Filo: 18 cm
Espesor de hoja: 3,5 mm
Mangos: 20.6 cm



TOPES DE NYLON

CALADO PARA CORTE DE RAMAS



Caja máster: 12 unidades

CODIGO	REF	MEDIDA/TIPO	UN.	PRECIO + IVA
17-11-123	18473	18.1/2"	Pza. 3	

TIJERA PODAR DOS MANOS

Mango madera, filo dentado

Con perilla de ajuste

ESPECIFICACIONES

Filo: 20.5 cm
Espesor de hoja: 4 mm
Mangos: 26 cm



Tope plástico

Filo dentado



Caja máster: 12 unidades

CODIGO	REF	MEDIDA/TIPO	UN.	PRECIO + IVA
17-11-122	18389	22.1/2"	Pza. 3	

TIJERA PODAR DOS MANOS

Mango madera

ESPECIFICACIONES

Filo: 21 cm
Espesor de hoja: 4 mm
Mangos: 25.5 cm



Caja máster: 36 unidades

CODIGO	REF	MEDIDA/TIPO	UN.	PRECIO + IVA
17-11-121	18377	21.1/2"	Pza. 3	

CUCHILLO CARTONERO INDUSTRIAL

Cuerpo metálico

- Cambio automático de cuchillas
- Incluye 5 cuchillas SK2



CODIGO	REF	MEDIDA/TIPO	UN.		PRECIO + IVA
17-12-005	16976	6"	Pza.	6	

CUCHILLO CARTONERO

Cuerpo plástico

Incluye 1 cuchilla de acero



CODIGO	REF	MEDIDA/TIPO	UN.		PRECIO + IVA
17-12-045	22403	5" x 9 mm	Pza.	12	
17-12-040	22405	6" x 18 mm	Pza.	12	

PRETUL®

AFILADOR DE CUCHILLOS

Para hoja lisa

- Muelas de carburo de tungsteno
- Cuerpo ABS
- Base con ventosa para fijar



CODIGO	REF	MEDIDA/TIPO	UN.		PRECIO + IVA
17-12-030	24140	-	Pza.	6	

CUCHILLO CARTONERO PROFESIONAL

Con alma metálica

- Cambio automático de cuchillas
- Incluye 3 cuchillas



CODIGO	REF	MEDIDA/TIPO	UN.		PRECIO + IVA
17-12-008	16977	6"	Pza.	12	

CUCHILLO ABATIBLE PARA ELECTRICISTA

Mango madera

Hoja curva de 3" (80 mm) de acero inoxidable 7Cr17MoV, 85% más durable



CODIGO	REF	MEDIDA/TIPO	UN.		PRECIO + IVA
17-12-022	18539	8"	Pza.	6	

REPUESTO PARA CARTONERO

Blíster con 10 cuchillas



CODIGO	REF	MEDIDA/TIPO	UN.		PRECIO + IVA
17-12-010	16965	6"	Pza.	12	

CUCHILLO PARA LINÓLEO

Fabricado en acero al alto carbono
Para linóleo, vinil, alfombra, etc.



CODIGO	REF	MEDIDA/TIPO	UN.		PRECIO + IVA
17-12-020	14462	7.1/2"	Pza.	6	

TIJERA MULTIUSO

Hojas de acero inoxidable

Sistema de resorte que reduce fatiga



CODIGO	REF	MEDIDA/TIPO	UN.	PRECIO + IVA
17-13-015	18493	8"	Pza. 6	

TIJERA MULTIUSO PARA COCINA

6 funciones

Incluye funda protectora



CODIGO	REF	MEDIDA/TIPO	UN.	PRECIO + IVA
17-13-040	100449	8"	Pza. 3	

TIJERA SASTRE

Para uso industrial o avícola

- Hojas rectas sobrepuestas
- Con tuercas de seguridad
- Acabado pulido

Empaque original: 6 pzas.



CODIGO	REF	MEDIDA/TIPO	UN.	PRECIO + IVA
17-13-010	18551	10"	Pza. 2	
17-13-011	18552	12"	Pza. 2	

TIJERA COSTURA Y OFICINA

Acero inoxidable

PRETUL®



CODIGO	REF	MEDIDA/TIPO	UN.	PRECIO + IVA
17-13-020	23154	6"	Pza. 6	
17-13-022	23158	8"	Pza. 6	

TIJERA BORDAR

Acero inoxidable

PRETUL®



CODIGO	REF	MEDIDA/TIPO	UN.	PRECIO + IVA
17-13-024	23176	4"	Pza. 6	

TIJERA CASA Y OFICINA

Hojas de acero inoxidable

PRETUL®



CODIGO	REF	MEDIDA/TIPO	UN.	PRECIO + IVA
17-13-028	23187	6"	Pza. 12	
17-13-030	23186	7"	Pza. 12	
17-13-026	23185	8"	Pza. 12	

SIERRA PARA ALUMINIO
80 dientes de carburo de tungsteno



Triple filo: La sierra alterna un diente en forma de trapecio y un diente en forma plana



CODIGO	REF	MEDIDA/TIPO	UN.	PRECIO + IVA
17-20-080	18310	10" - 5/8"	Pza. 3	

TIJERA DE AVIACIÓN RECTA
Acero cromo molibdeno

- Mangos ergonómicos confortables que permiten cortes fáciles
- Recubrimiento niquelado para mayor resistencia a la corrosión



CODIGO	REF	MEDIDA/TIPO	UN.	PRECIO + IVA
17-20-065	18531	-	Pza. 3	

REMACHADORA
Incluye llave

PRETUL®

- Con 4 boquillas:
- 2,4 mm
- 3,2 mm
- 4,0 mm
- 4,8 mm



CODIGO	REF	MEDIDA/TIPO	UN.	PRECIO + IVA
17-20-040	22850	10"	Pza. 3	

TIJERA PARA HOJALATERO
Forjada en acero al carbono

- Cómodo mango de vinil acojinado
- Recubrimiento satinado, 3 veces más resistente a la corrosión



CODIGO	REF	MEDIDA/TIPO	UN.	PRECIO + IVA
17-20-055	18501	10"	Pza. 4	
17-20-057	18502	12"	Pza. 4	

TIJERA DE AVIACIÓN DERECHA
Acero cromo molibdeno

- Mangos ergonómicos confortables que permiten cortes fáciles
- Recubrimiento niquelado para mayor resistencia a la corrosión



CODIGO	REF	MEDIDA/TIPO	UN.	PRECIO + IVA
17-20-067	18535	-	Pza. 3	

REMACHADORA PROFESIONAL
Cilindro de acero al carbono, incluye llave

- Con 4 boquillas:
- 2,4 mm
- 3,2 mm
- 4,0 mm
- 4,8 mm



CODIGO	REF	MEDIDA/TIPO	UN.	PRECIO + IVA
17-20-042	17960	10"	Pza. 3	

TIJERA DE AVIACIÓN IZQUIERDA
Acero cromo molibdeno

- Mangos ergonómicos confortables que permiten cortes fáciles
- Recubrimiento niquelado para mayor resistencia a la corrosión



CODIGO	REF	MEDIDA/TIPO	UN.	PRECIO + IVA
17-20-069	18534	-	Pza. 3	

REMACHADORA TIPO ACORDEÓN

- Con 5 boquillas:
- 3,2 mm
- 4,0 mm
- 4,8 mm
- 6,0 mm
- 6,4 mm



CODIGO	REF	MEDIDA/TIPO	UN.	PRECIO + IVA
17-20-044	17962	11" a 29"	Pza. 2	

TECLE DE MANIVELA

Ganchos forjados de acero al medio carbono

- Sistema que minimiza el esfuerzo al arrastrar la carga
- Activación automática de freno
- Diámetro de cable **5 mm**
- No sobrepase el límite máximo de trabajo



CODIGO	REF	MEDIDA/TIPO	UN.	PRECIO + IVA
17-20-003	14720	650 kg / 9 m	Pza. 1	

TECLE DE PALANCA

Ganchos forjados de acero al medio carbono

- Engrane de acero de doble cremallera para mayor resistencia
- Botón de seguridad que libera el mecanismo
- Diámetro de cable **6 mm**
- Siempre mantenga por lo menos 3 vueltas de cable en el tambor

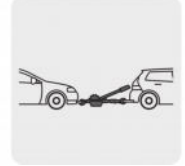
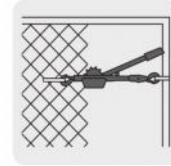

CODIGO	REF	MEDIDA/TIPO	UN.	PRECIO + IVA
17-20-001	14725	2 t / 57-195 cm	Pza. 1	
17-20-002	14727	4 t / 65-200 cm	Pza. 1	

MALLA DE FAENA
 Polietileno de alta densidad

Resistente contra rayos UV

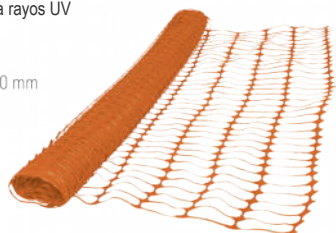
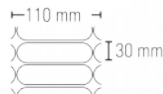

CODIGO	REF	MEDIDA/TIPO	UN.	PRECIO + IVA
17-22-150	15264	1,2 x 30 m	Rollo 1	

RODILLERAS LIGERAS
 Fabricadas en EVA y gel, forro transpirable

Ideal para superficies planas como azulejo, concreto, etc.
 Ajuste con bandas elásticas



CODIGO	REF	MEDIDA/TIPO	UN.	PRECIO + IVA
17-22-120	12951	-	Par 2	

ARNÉS DE SEGURIDAD
 100% poliéster

- Capacidad de carga: 140 kg
- Tensión máxima: 2300 kg



Caja máster: 2 unidades

CODIGO	REF	MEDIDA/TIPO	UN.	PRECIO + IVA
17-22-127	14431	Ancho 4 cm	Pza. 1	

PÚA CONCERTINA
 Fabricada en lámina de acero

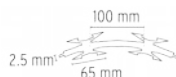

CODIGO	REF	MEDIDA/TIPO	UN.	PRECIO + IVA
17-22-170	44920	8 m x Ø45 cm	Pza. 1	

PROTECTOR DE OÍDOS
 Tipo audifono

Altura de diadema ajustable
 Rango de reducción de ruido de 18 db



CODIGO	REF	MEDIDA/TIPO	UN.	PRECIO + IVA
17-22-125	14257	-	Pza. 4	

OVEROL DESECHABLE
 Repelente de líquidos no abrasivos

Fabricado en polipropileno



CODIGO	REF	MEDIDA/TIPO	UN.	PRECIO + IVA
17-22-001	14421	L	Pza. 5	
17-22-003	14422	XL	Pza. 5	

MASCARILLA CON VÁLVULA
Tipo N95, para aplicaciones industriales

Válvula de exhalación que reduce calor, humedad y empañamiento



CODIGO	REF	MEDIDA/TIPO	UN.	PRECIO + IVA
17-22-078	19757	-	Pza. 6	

RESPIRADOR SIMPLE
Con válvula de exhalación

No incluye filtros



CODIGO	REF	MEDIDA/TIPO	UN.	PRECIO + IVA
17-22-085	23390	-	Pza. 4	

PRETUL® GUANTE DE LÁTEX
Uso doméstico



CODIGO	REF	MEDIDA/TIPO	UN.	PRECIO + IVA
17-22-058	14262	M	Par 6	
17-22-056	14263	L	Par 6	

RESPIRADOR DOBLE
Con válvula de exhalación

No incluye filtros



CODIGO	REF	MEDIDA/TIPO	UN.	PRECIO + IVA
17-22-080	23391	-	Pza. 4	

PRETUL® GUANTE DE LÁTEX
Uso doméstico



CODIGO	REF	MEDIDA/TIPO	UN.	PRECIO + IVA
17-22-050	23260	M	Par 12	

FILTROS
Para respirador doble y simple

Eficiencia de filtrado del 90%



CODIGO	REF	MEDIDA/TIPO	UN.	PRECIO + IVA
17-22-082	23393	Polvo	Pza. 6	
17-22-083	23394	Pintura	Pza. 6	
17-22-086	23392	Vapores orgánicos	Pza. 6	
17-22-089	23395	Vapores inorgánicos	Pza. 6	
17-22-090	23396	Gases ácidos	Pza. 6	

GUANTE PIEL DE CABRA/CARNAZA

Uso general

Alta flexibilidad y confort



CODIGO	REF	MEDIDA/TIPO	UN.	PRECIO + IVA
17-22-041	14288	Unitalla	Par 6	

GUANTE PIEL DE RES/LONA

Uso general

Mayor flexibilidad y resistencia a la abrasión que la carnaza



CODIGO	REF	MEDIDA/TIPO	UN.	PRECIO + IVA
17-22-048	17051	Unitalla	Par 6	

GUANTE POLIESTER

Palma con puntos de PVC

- Alta sensibilidad y ajuste
- Buen agarre para procesos secos (no solventes)



CODIGO	REF	MEDIDA/TIPO	UN.	PRECIO + IVA
17-22-076	12652	L	Par 6	

GUANTE PIEL DE RES

Uso general

Ofrecen comodidad, resistencia a la abrasión y buena ventilación



CODIGO	REF	MEDIDA/TIPO	UN.	PRECIO + IVA
17-22-042	17053	Unitalla	Par 6	

GUANTE SOLDADOR

Puño largo

Excelente desempeño y protección contra chispas y salpicaduras al soldar



CODIGO	REF	MEDIDA/TIPO	UN.	PRECIO + IVA
17-22-070	19458	Unitalla	Par 6	

GUANTES DE NYLON ELÁSTICO

Recubierto en nitrilo

- Excelente agarre en superficies secas
- Carga de mercancía en general
- Procesos ligeramente húmedos



CODIGO	REF	MEDIDA/TIPO	UN.	PRECIO + IVA
17-22-038	13293	S	Par 6	
17-22-039	13294	M	Par 6	
17-22-040	13295	L	Par 6	

GUANTE PIEL DE CABRA

Para electricista

Alta flexibilidad y confort



CODIGO	REF	MEDIDA/TIPO	UN.	PRECIO + IVA
17-22-044	14286	Unitalla	Par 6	

GUANTE CARNAZA

Uso general

Resistencia a materiales abrasivos y perforación



CODIGO	REF	MEDIDA/TIPO	UN.	PRECIO + IVA
17-22-072	14240	L	Par 6	

GUANTES NYLON P/MECÁNICOS U OTROS

Recubierto de poliuretano

- Alta destreza y sensibilidad en el manejo de piezas pequeñas
- Procesos secos



CODIGO	REF	MEDIDA/TIPO	UN.	PRECIO + IVA
17-22-140	13291	M	Par 12	
17-22-142	13292	L	Par 12	

GUANTE PIEL DE CERDO

Uso general

Mayor flexibilidad, y sensibilidad que los guantes de piel de res



CODIGO	REF	MEDIDA/TIPO	UN.	PRECIO + IVA
17-22-046	14999	Unitalla	Par 6	

GUANTE CARNAZA/LONA

Uso general

Resistencia a materiales abrasivos, al desgarre y perforación



CODIGO	REF	MEDIDA/TIPO	UN.	PRECIO + IVA
17-22-074	14245	Unitalla	Par 6	

LENES DE SEGURIDAD

Mica transparente, 100% policarbonato

- Protección UV y antirayadura
- Ventilación lateral antiempañante



CODIGO	REF	MEDIDA/TIPO	UN.	PRECIO + IVA
17-22-031	14252	-	Pza. 12	

LENES DE SEGURIDAD DEPORTIVOS

Color gris, con protección UV y antiralladura

- Mica 100% policarbonato
- Marco ajustable



CODIGO	REF	MEDIDA/TIPO	UN.	PRECIO + IVA
17-22-020	14302	-	Pza. 6	

LENES DE SEGURIDAD LIGEROS

Color gris, con protección UV y antiralladura

- Mica 100% policarbonato
- Diseño ultraligero



CODIGO	REF	MEDIDA/TIPO	UN.	PRECIO + IVA
17-22-028	15290	-	Pza. 6	

GAFAS DE SEGURIDAD PROFESIONALES

Mica transparente, 100% policarbonato

- Armazón suave y flexible
- Excelente visión panorámica
- Protector UV y antirayadura
- Antiempañe



CODIGO	REF	MEDIDA/TIPO	UN.	PRECIO + IVA
17-22-030	14214	-	Pza. 6	

CASCO DE SEGURIDAD

Poliétileno de alta densidad

- Resistencia eléctrica hasta 20.000 V
- Ajuste de matraca



CODIGO	REF	MEDIDA/TIPO	UN.	PRECIO + IVA
17-22-060	10370	Blanco	Pza. 4	
17-22-062	10371	Azul	Pza. 4	
17-22-064	14294	Amarillo	Pza. 4	
17-22-068	10373	Rojo	Pza. 4	

PROTECTOR FACIAL



Mica de policarbonato compatible c/otras marcas



CODIGO	REF	MEDIDA/TIPO	UN.	PRECIO + IVA
17-22-011	26007	20 x 30 cm	Pza. 4	

PROTECTOR FACIAL

Mica de policarbonato antiralladura



CODIGO	REF	MEDIDA/TIPO	UN.	PRECIO + IVA
17-22-010	14221	20 x 40 cm	Pza. 2	

Mica de repuesto:

17-22-008	14222	-	Pza. 6	
-----------	-------	---	--------	--

MÁSCARA ELECTRÓNICA

Fabricada en polipropileno



- Sensibilidad de retardo con ajuste de perilla
- Sombra #4 en estado pasivo
- Velocidad de oscurecimiento 1/25,000 s
- 2 sensores de arco para una respuesta más exacta

Incluye 3 micas



CODIGO	REF	MEDIDA/TIPO	UN.	PRECIO + IVA
17-22-014	29978	-	Pza. 1	

LETRERO “SALIDA DE EMERGENCIA”

Fotoluminiscente



CODIGO	REF	MEDIDA/TIPO	UN.	PRECIO + IVA
17-22-200	18348	21 x 28 cm	Pza. 5	

LETRERO “CABALLEROS”



CODIGO	REF	MEDIDA/TIPO	UN.	PRECIO + IVA
17-22-208	18474	19 x 19 cm	Pza. 5	

LETRERO “ABIERTO/CERRADO”

Incluye ventosa y gancho



CODIGO	REF	MEDIDA/TIPO	UN.	PRECIO + IVA
17-22-216	18239	28 x 12 cm	Pza. 5	

LETRERO “RUTA EVACUACIÓN DERECHA”

Fotoluminiscente



CODIGO	REF	MEDIDA/TIPO	UN.	PRECIO + IVA
17-22-202	18368	21 x 28 cm	Pza. 5	

LETRERO “DAMAS”



CODIGO	REF	MEDIDA/TIPO	UN.	PRECIO + IVA
17-22-210	18478	19 x 19 cm	Pza. 5	

LETRERO “NO FUMAR”



CODIGO	REF	MEDIDA/TIPO	UN.	PRECIO + IVA
17-22-218	18293	19 x 19 cm	Pza. 5	

LETRERO “RUTA EVACUACIÓN IZQUIERDA”

Fotoluminiscente



CODIGO	REF	MEDIDA/TIPO	UN.	PRECIO + IVA
17-22-204	18369	21 x 28 cm	Pza. 5	

LETRERO “EXCLUSIVO”



CODIGO	REF	MEDIDA/TIPO	UN.	PRECIO + IVA
17-22-212	18479	19 x 19 cm	Pza. 5	

LETRERO “NO ESTACIONARSE”



CODIGO	REF	MEDIDA/TIPO	UN.	PRECIO + IVA
17-22-220	18347	25 x 34 cm	Pza. 5	

LETRERO “FLECHA”

Fotoluminiscente

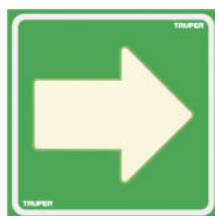

CODIGO	REF	MEDIDA/TIPO	UN.	PRECIO + IVA
17-22-206	18433	19 x 19 cm	Pza. 5	

“DEPOSITE LA BASURA EN SU LUGAR”



CODIGO	REF	MEDIDA/TIPO	UN.	PRECIO + IVA
17-22-214	18529	21 x 28 cm	Pza. 5	

LETRERO “EXTINTOR”

Fotoluminiscente



CODIGO	REF	MEDIDA/TIPO	UN.	PRECIO + IVA
17-22-222	18434	19 x 19 cm	Pza. 5	

CAJA PARA HERRAMIENTAS

Calidad industrial

- Fabricada en polipropileno
- Cierres metálicos
- Incluye bandeja para herramientas
- Desde 20" con 2 cierres
- Color negro



CODIGO	REF	MEDIDA/TIPO	UN.		PRECIO + IVA
17-23-001	19656	17"	Pza.	2	
17-23-003	10380	20"	Pza.	2	
17-23-005	11506	23"	Pza.	2	
17-23-007	19882	26"	Pza.	1	

CAJA HERRAMIENTAS MODELO ANCHO

Calidad industrial

- Fabricada en polipropileno
- Incluye bandeja para herramientas
- Color negro



CODIGO	REF	MEDIDA/TIPO	UN.		PRECIO + IVA
17-23-009	19854	14"	Pza.	3	
17-23-011	19790	16"	Pza.	2	
17-23-013	19781	19"	Pza.	2	
17-23-015	19780	22"	Pza.	1	

BOLSO PARA HERRAMIENTAS

Para uso rudo

- Color "negro / naranja"
- Compartimientos múltiples.
- Asas y correa al hombro reforzadas para mayor comodidad
- Correa ajustable



Empaque original: 4 unidades

CODIGO	REF	MEDIDA/TIPO	UN.		PRECIO + IVA
17-23-100	17103	18"	Pza.	1	

CAJA PARA HERRAMIENTAS

Con ruedas y mango telescópico

- Fabricada en polipropileno
- Soporta hasta 40 kg
- Ruedas grandes de 7.1/2"
- Peso: 5,5 kg
- Color negro

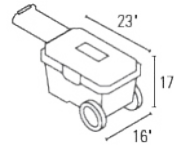

Bandeja
desmontable
2 posiciones
(interior-exterior)
13.5/8" x 12.1/4"

Caja máster: 2 unidades

(no incluye herramientas)

CODIGO	REF	MEDIDA/TIPO	UN.		PRECIO + IVA
17-23-020	10902	23"- 57L	Pza.	1	

ORGANIZADOR DE PARED

Módulos de polipropileno traslúcido

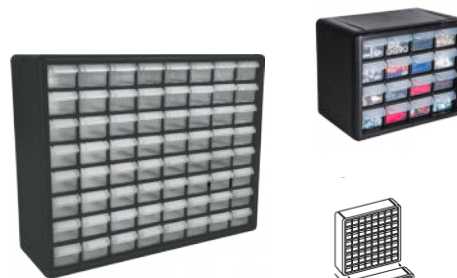

Rieles para apilar

MEDIDAS:

- 16 mod: 27 x 22 x 16 cm
- 44 mod: 51 x 40 x 16 cm (12 gavetas medianas, 32 chicas)
- 64 mod: 51 x 40 x 16 cm

CODIGO	REF	MEDIDA/TIPO	UN.		PRECIO + IVA
17-23-052	11851	16 módulos	Pza.	1	
17-23-038	102642	44 módulos	Pza.	1	
17-23-050	10895	64 módulos	Pza.	1	

ORGANIZADOR

Fabricado en polipropileno

MEDIDAS:
11 mod: 23 x 15 x 3.8 cm
15 mod: 28 x 18 x 4.4 cm
18 mod: 36 x 28 x 6 cm



(no incluye herramientas)

CODIGO	REF	MEDIDA/TIPO	UN.		PRECIO + IVA
17-23-034	10035	11 módulos	Pza.	6	
17-23-032	19896	15 módulos	Pza.	6	
17-23-030	11825	18 módulos	Pza.	3	

ORGANIZADOR REFORZADO

Fabricado en polipropileno

Seguro adicional para evitar que el contenido se salga del interior

MEDIDAS:
17" x 12.1/2" x 3.1/2"



CODIGO	REF	MEDIDA/TIPO	UN.		PRECIO + IVA
17-23-040	19939	17 módulos	Pza.	3	

ORGANIZADOR APILABLE PLÁSTICO

Fabricado en polipropileno



CODIGO	REF	MEDIDA/TIPO	UN.		PRECIO + IVA
17-23-042	10889	16.5 x 10.5 x 7.5 cm	Pza.	6	
17-23-044	10890	24.5 x 17 x 11 cm	Pza.	6	
17-23-046	10891	34 x 21 x 15 cm	Pza.	6	
17-23-041	11201	41 x 31 x 18 cm	Pza.	4	

PISO/TABURETE DE 2 PELDAÑOS

Fabricado en polipropileno de una sola pieza

- Uso doméstico
- Peldaños antideslizantes
- Carga hasta 136 kg

MEDIDAS:
 Base: 47 cm
 Altura: 44 cm
 Fondo: 47 cm
 Peso: 2 kg



CODIGO	REF	MEDIDA/TIPO	UN.		PRECIO + IVA
17-23-110	10499	-	Pza.	2	

CANASTO DE USO MÚLTIPLE

Fabricado en polipropileno



(no incluye útiles)

CODIGO	REF	MEDIDA/TIPO	UN.		PRECIO + IVA
17-23-060	10037	50x 34x19 cm	Pza.	3	

GANCHO MULTIUSO

Para montaje en pared

- Acero al carbono recubierto de PVC que no daña los objetos
- Doble agujero de montaje 5 y 11 mm
- Capacidad de carga hasta 120 kg



CODIGO	REF	MEDIDA/TIPO	UN.		PRECIO + IVA
17-23-120	11104	10 cm	Pza.	4	

ESTANTE PLÁSTICO

5 repisas, uso rudo

- Fabricado en plástico resistente y durable
- Repisas en forma de panel que permite una distribución uniforme de carga para mayor estabilidad y resistencia
- De fácil limpieza
- Ideal para organizar y exhibir artículos optimizando espacio
- Capacidad máxima de carga por repisa: estante 68 kg / 340 kg (distribuida uniformemente)

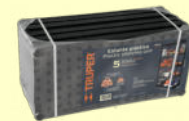

(no incluye útiles)

CODIGO	REF	MEDIDA/TIPO	UN.		PRECIO + IVA
17-23-204	19943	185 x 91 x 43 cm	Pza.	1	

CONECTOR COAXIAL DE ENROSCAR

Bolsa 4 unidades



CODIGO	REF	MEDIDA/TIPO	UN.	PRECIO + IVA
17-24-001	48481	RG59	Bolsa 10	
17-24-004	48482	RG6	Bolsa 20	

CONECTOR COAXIAL DE BARRIL

Bolsa 4 unidades



CODIGO	REF	MEDIDA/TIPO	UN.	PRECIO + IVA
17-24-007	48483	RG59	Bolsa 10	
17-24-010	48484	RG6	Bolsa 10	

DIVISOR COAXIAL (SPLITTER)

1 entrada, 2, 3 y 4 salidas



CODIGO	REF	MEDIDA/TIPO	UN.	PRECIO + IVA
17-24-020	48477	4 salidas	Pza. 10	
17-24-022	48476	3 salidas	Pza. 10	
17-24-024	48475	2 salidas	Pza. 20	

CABLE COAXIAL

Rollos de 300 metros en carrete plástico



CODIGO	REF	MEDIDA/TIPO	UN.	PRECIO + IVA
17-24-014	45028	RG59	Metro 300	
17-24-017	45030	RG6	Metro 300	

CABLE COAXIAL

Rollos de 100 metros



Caja máster: 4 rollos de 100 m

CODIGO	REF	MEDIDA/TIPO	UN.	PRECIO + IVA
17-24-016	48474	RG6	Metro 100	

CABLE PARA PARLANTES

Rollo 100 m



- Aluminio revestido de cobre
- Forro de PVC

ESPECIFICACIONES:
Calibre: 22 AWG
Diámetro: 2 mm
Hilos: 11



Caja máster: 4 rollos

CODIGO	REF	MEDIDA/TIPO	UN.	PRECIO + IVA
17-24-040	46264	Bicolor	Rollo 1	
17-24-042	46265	Polarizado	Rollo 1	

SOLDADURA PARA ELECTRÓNICA

Con núcleo de resina 60/40

ESPECIFICACIONES:
Diámetro: 1 mm
Largo: 76 m
Peso: 450 g
Punto de fusión: 190 °C

60% Estaño
40% Plomo



Núcleo de resina

CODIGO	REF	MEDIDA/TIPO	UN.	PRECIO + IVA
17-24-070	14366	450 g	Pza. 2	

PROBADOR CORRIENTE C.C.

Ideal para circuitos de 12 V

- Para medición de baterías y circuitos
- Cable de 1 m
- Uso rudo



CODIGO	REF	MEDIDA/TIPO	UN.	PRECIO + IVA
17-24-060	13986	12v	Pza. 6	

PROBADOR DIGITAL CORRIENTE C.A./C.C.

Punta tipo desarmador

- Medición individual de C.A. / C.C.
- 12 – 36 – 55 – 110 – 220 V



CODIGO	REF	MEDIDA/TIPO	UN.	PRECIO + IVA
17-24-062	18333	12 a 220v	Pza. 6	

TESTER DIGITAL Junior

- Prueba de continuidad audible y diodo
- Incluida batería de 9 V

Tensión CC / CA	200 mV - 1,000 V / 200 V - 750 V
Corriente CC	200 µA - 10 A
Resistencia	200 Ohm - 2 M Ohm
Temperatura (°C)	-40° C a 1,370° C



Caja máster: 2 unidades

CODIGO	REF	MEDIDA/TIPO	UN.	PRECIO + IVA
17-24-030	10401	MUT-33	Pza. 1	

TESTER DIGITAL Escolar

- Prueba de diodo y transistor
- Incluida batería de 9 V

Tensión CC / CA	200 mV - 1,000 V / 200 V - 750 V
Corriente CC	200 µA - 10 A
Resistencia	200 Ohm - 2,000 k Ohm



Caja máster: 4 unidades

CODIGO	REF	MEDIDA/TIPO	UN.	PRECIO + IVA
17-24-026	10400	MUT-830	Pza. 1	

TESTER DIGITAL Profesional

- Prueba de continuidad audible, diodo, transistor NPN o PNP (0-1,000 B)
- Mayor precisión en mediciones de CA (True RMS)
- Sistema de auto apagado (APO)
- Incluida batería de 9 V

TRUE RMS

Tensión CC / CA	200 mV - 1,000 V / 2V - 750 V
Corriente CC / CA	2 mA - 20 A / 200 mA - 20 A
Resistencia	200 Ohm - 20 M Ohm
Temperatura (°C)	-40° C a 1,000° C
Capacitancia	20 nF - 20 mF
Frecuencia	0 - 60 MHz



Caja máster: 2 unidades

CODIGO	REF	MEDIDA/TIPO	UN.	PRECIO + IVA
17-24-028	10402	MUT-39	Pza. 1	

TESTER DIGITAL De gancho

- Prueba de continuidad audible y diodo
- Incluida batería de 9 V

TRUE RMS

Tensión CC / CA	600 mV - 1,000 V / 600 mV - 750 V
Corriente CA	60 A - 1,000 A
Resistencia	600 Ohm - 60 M Ohm
Temperatura (°C)	-40° C a 1,370° C



Incluye estuche

Caja máster: 2 unidades

CODIGO	REF	MEDIDA/TIPO	UN.	PRECIO + IVA
17-24-032	10404	MUT-202	Pza. 1	

TESTER DIGITAL Para mantenimiento Automotriz

- Prueba de continuidad audible, diodo, transistor NPN o PNP (0-1,000 B)
- Mayor precisión en mediciones de CA (True RMS)
- Sistema de auto apagado (APO)
- Incluida batería de 9 V

TRUE RMS

Tensión CC / CA	200 mV - 1,000 V / 200 V - 750 V
Corriente CC / CA	200 mA - 20 A / 200 mA - 20 A
Resistencia	200 Ohm - 20 M Ohm
Temperatura (°C)	-40° C a 1,000° C
Ángulo contacto de platinos	A Cyl / 6 Cyl / 8 Cyl
Tacómetro	4 Cyl / 9 Cyl / 8 Cyl
Capacitancia	20 nF - 20 mF
Frecuencia	0 - 60 MHz



Caja máster: 2 unidades

CODIGO	REF	MEDIDA/TIPO	UN.	PRECIO + IVA
17-24-034	10403	MUT-105	Pza. 1	

SOPORTE PARA TV ARTICULADO
Fabricado en acero



- Distancia ajustable de la pared a la TV: 8 a 48 cm
- Soporta hasta 60 kg
- Incluye tornillería

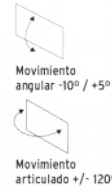

CODIGO	REF	MEDIDA/TIPO	UN.	PRECIO + IVA
17-24-080	46096	26" a 65"	Pza. 1	

SOPORTE TV CON INCLINACIÓN AJUSTABLE
Fabricado en acero



- Distancia ajustable de la pared a la TV: 4 cm
- Soporta hasta 82 kg
- Incluye tornillería



CODIGO	REF	MEDIDA/TIPO	UN.	PRECIO + IVA
17-24-082	46093	26" a 65"	Pza. 1	

ACEITE AFLOJATODO

En aerosol

- Elimina la humedad
- Limpia lubrica y protege
- Libera mecanismos trabados



Caja máster: 16 un.

CODIGO	REF	MEDIDA/TIPO	UN.	PRECIO + IVA
18-25-001	13471	400 ml	Pza. 12	
18-25-003	13469	235 ml	Pza. 4	

ACEITE AFLOJATODO

Lata compacta para caja de herramientas

- Elimina la humedad
- Limpia lubrica y protege
- Libera mecanismos trabados



Caja máster: 24 un.

CODIGO	REF	MEDIDA/TIPO	UN.	PRECIO + IVA
18-25-005	13468	110 ml	Pza. 6	

ACEITE MULTIUSO

- Protegen de oxidación y corrosión
- Limpian superficies metálicas



CODIGO	REF	MEDIDA/TIPO	UN.	PRECIO + IVA
17-25-007	16711	30 ml	Pza. 10	
17-25-008	16712	90 ml	Pza. 10	

ACEITE SINTÉTICO

Para motor de 2 tiempos



Para mezclas 50:1 – 40:1 – 32:1 – 16:1



CODIGO	REF	MEDIDA/TIPO	UN.	PRECIO + IVA
17-25-011	14991	60 ml / 2 oz	Pza. 10	
17-25-012	17624	100 ml / 3 oz	Pza. 6	
17-25-014	17625	400 ml / 14 oz	Pza. 6	

ACEITE SEMI-SINTÉTICO

Para motor de 4 tiempos

Alto índice de viscosidad, grado SAE 10W-30



CODIGO	REF	MEDIDA/TIPO	UN.	PRECIO + IVA
17-25-040	14928	0.5 L	Pza. 6	
17-25-042	14929	1 L	Pza. 6	

ACEITERA DE PIPETA FLEXIBLE

- Mecanismo interno metálico
- Boquilla con punta de latón sólido
- Aplicador flexible



CODIGO	REF	MEDIDA/TIPO	UN.	PRECIO + IVA
17-25-018	14870	180 ml	Pza. 6	
17-25-020	14872	300 ml	Pza. 6	
17-25-022	14874	500 ml	Pza. 6	

GRASA LUBRICANTE MULTIUSO

Fabricada en jabón a base de litio

- Resistente al agua
- Lubrica y evita la corrosión
- Para chasis, equipo agrícola, industrial, de construcción



CODIGO	REF	MEDIDA/TIPO	UN.	PRECIO + IVA
17-25-010	12783	450 g	Pza. 4	

EMBUDO CUELLO RIGIDO

Para gasolina y uso general

- Fabricado en polipropileno
- Cuello largo para sostenerse solo en el tanque a rellenar
- Con orificio para colgar



Para llenado de bidones, tanques, tambos, etc.



CODIGO	REF	CAPACIDAD	UN.		PRECIO + IVA
17-25-054	11205	250 ml	Pza.	6	

EMBUDO CUELLO FLEXIBLE

Ideal para aceites

- Fabricado en polipropileno
- Dos piezas, extensión con rosca
- Agarredera para mejor control
- Incluye filtro rejilla para sólidos

MEDIDAS:
Largo 38 cm
Diámetro boquilla 15 cm



CODIGO	REF	CAPACIDAD	UN.		PRECIO + IVA
17-25-052	11207	500 ml	Pza.	6	

MEZCLADORA DE GASOLINA Y ACEITE

Botella de polietileno de alta densidad

- Boquilla reducida que facilita la descarga
- Boca amplia para llenado
- Marcas que permiten preparar la mezcla correcta 50:1, 32:1, 40:1, 25:1, 16:1
- Marca para mezcla de 500 ml o 1 L



CODIGO	REF	CAPACIDAD	UN.		PRECIO + IVA
17-25-100	101780	1 L	Pza.	4	

BOMBA MANUAL DE EXTRACCIÓN

25 litros por minuto

Para aceite, petróleo, queroseno y diesel
Tuerca de fijación al tambor de 200L
Cuerpo de hierro
Tubo de acero

ESPECIFICACIONES:
Flujo: 0.3 L/bombeo
Tubo de 1 m x Ø1.1/4"



Caja máster: 4 un.

CODIGO	REF	MEDIDA/TIPO	UN.		PRECIO + IVA
17-25-033	10067	100 cm	Pza.	1	

BOMBA EXTRACTORA DE SOLVENTES

Cuerpo de hierro

- Para alcohol, etanol, metanol, propanol, benceno, agua, glicerina, aceite, diesel, gasolina, queroseno, thinner, acetona, tolueno y xileno
- Tuerca de fijación al tambor de 200L
Cuerpo de hierro
Tubo de acero



ESPECIFICACIONES:
Flujo: 0.3 L/bombeo
Tubo de 87 cm x Ø1.1/2"

Caja máster: 4 un.

CODIGO	REF	MEDIDA/TIPO	UN.		PRECIO + IVA
17-25-035	16853	87 cm	Pza.	1	

CANDADO PARA MALETA



Combinación de 3 dígitos personalizable



CODIGO	REF	MEDIDA/TIPO	UN.	PRECIO + IVA
17-26-022	43351	36 mm	Pza. 6	

CANDADO PARA MALETA



Combinación de 3 dígitos personalizable



CODIGO	REF	MEDIDA/TIPO	UN.	PRECIO + IVA
17-26-020	43350	25 mm	Pza. 6	

CANDADO DE HIERRO



Incluye 2 llaves

- Cuerpo de hierro con acabado color latón y gancho corto de acero con acabado cromado
- Cilindro metálico, seguro tipo perso seguridad estándar
- Mecanismo interno resistente a la corrosión



CODIGO	REF	MEDIDA/TIPO	UN.	PRECIO + IVA
--------	-----	-------------	-----	--------------

En caja

17-26-236	23522	30 mm	Pza. 12	
17-26-240	23518	40 mm	Pza. 12	

En blíster

17-26-230	22527	20 mm	Pza. 6	
17-26-232	22529	25 mm	Pza. 6	
17-26-234	23523	30 mm	Pza. 6	
17-26-238	23520	40 mm	Pza. 6	
17-26-242	23521	50 mm	Pza. 6	

CANDADO MÁX SEGURIDAD



Incluye 3 llaves

- Cilindro de latón sólido
- Llave anti-ganzúa
- gancho anti-robot
- Resistencia a golpes



CODIGO	REF	MEDIDA/TIPO	UN.	PRECIO + IVA
17-26-040	43334	50 mm	Pza. 2	
17-26-042	43335	60 mm	Pza. 2	

CANDADOS DE HIERRO



Set de 2 piezas

- Cilindro de latón sólido
- Antirrobo: grillete de acero templado para resistir cortes de segueta, cortapernos y perforaciones
- Incluye 2 llaves (los 2 candados abren con la misma llave)



CODIGO	REF	MEDIDA/TIPO	UN.	PRECIO + IVA
17-26-025	43321	38 mm	Set 6	

CANDADOS DE HIERRO



Set de 4 piezas

- Cilindro de latón sólido
- Antirrobo: grillete de acero templado para resistir cortes de segueta, cortapernos y perforaciones
- Incluye 4 llaves (los 4 candados abren con la misma llave)



CODIGO	REF	MEDIDA/TIPO	UN.	PRECIO + IVA
17-26-030	43333	38 mm	Set 3	

CANDADO DE CABLE

Acero trenzado, incluye 2 llaves



Incluye 2 llaves y portacandado para cuadro de bicicleta



Llave tipo automotriz

ESPECIFICACIONES:
Diámetro cable: 10 mm
Largo cable: 1 metro



CODIGO	REF	MEDIDA/TIPO	UN.	PRECIO + IVA
17-26-001	43922	1 m	Pza. 3	

CANDADO DE CABLE

Acero trenzado, combinación de 4 dígitos



- Combinación fija de 4 dígitos
- Incluye portacandado para cuadro de bicicleta

ESPECIFICACIONES:
Diámetro cable: 8 mm
Largo cable: 1 metro



CODIGO	REF	MEDIDA/TIPO	UN.	PRECIO + IVA
17-26-003	43924	1 m	Pza. 6	

CAJA SEGURIDAD

Fabricada en acero



INCLUYE:
2 llaves
Bandeja con 5 compartimientos



CODIGO	REF	MEDIDA/TIPO	UN.	PRECIO + IVA
17-26-076	46798	15 cm / 6 comp.	Pza. 1	
17-26-070	43074	20 cm / 3 comp.	Pza. 1	
17-26-072	43076	30 cm / 5 comp.	Pza. 1	

CAJA SEGURIDAD ELECTRÓNICA

Capacidad 20 litros



- Combinación de 3 a 8 dígitos que no requiere cambiarse con cada apertura
- Para programar 1 código de usuario
- Entrada de llave oculta, para poderla abrir en caso de olvidar la combinación
- Fabricadas en acero
- Empotrable a la pared o piso
- Peso 7 kg



- 2 Pernos para mayor seguridad
- Utiliza 4 pilas AA, no incluidas
- Incluye 2 llaves tubulares
- Incluye tornillería

CODIGO	REF	MEDIDA/TIPO	UN.	PRECIO + IVA
17-26-074	43081	35 x 25 x 25 cm	Pza. -	

CAJA PARA 36 LLAVES

Fabricada en acero



INCLUYE:
2 llaves
Etiquetas numéricas
Tornillería para instalación



CODIGO	REF	MEDIDA/TIPO	UN.	PRECIO + IVA
17-26-120	43068	18 x 25 x 8 cm	Pza. 1	

CAJA GUARDALLAVES DE PARED

Combinación de 4 dígitos personalizable



- Cuerpo fabricado en aluminio
- Resistente a la intemperie
- Almacena hasta 5 llaves
- Empotrable en pared



CODIGO	REF	MEDIDA/TIPO	UN.	PRECIO + IVA
17-26-069	45328	12 x 4 x 10 cm	Pza. 2	

CERRADURA CAJONERA

Incluye 2 llaves



- Cilindro con sistema de pernos
- Acción vertical

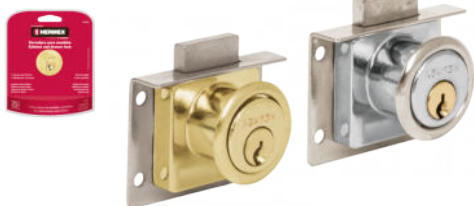

CODIGO	REF	MEDIDA/TIPO	UN.	Pza.	PRECIO + IVA
17-26-050	43565	Latón	6		
17-26-052	43557	Cromo	6		

CERRADURA PARA MUEBLE

Incluye 2 llaves

- Cilindro con sistema de pernos



CODIGO	REF	MEDIDA/TIPO	UN.	Pza.	PRECIO + IVA
17-26-112	43569	Latón	6		
17-26-114	43561	Cromo	6		

CERRADURA VITRINA

Incluye 2 llaves



- Cilindro de latón sólido



CODIGO	REF	MEDIDA/TIPO	UN.	Pza.	PRECIO + IVA
17-26-060	43535	11.9 x 3.2 cm	6		

PASADOR CON CADENA

Incluye tornillería



CODIGO	REF	MEDIDA/TIPO	UN.	Pza.	PRECIO + IVA
17-26-094	43707	Latón	6		
17-26-092	43709	Cromo	6		

CERROJO LLAVE MARIPOSA

Incluye 2 llaves

- Para puertas derechas o izquierdas de 1-1/4" a 1-3/4" (32 a 45 mm)



CODIGO	REF	MEDIDA/TIPO	UN.	Pza.	PRECIO + IVA
17-26-062	23613	Latón	4		
17-26-064	23614	Cromo	4		

CERRADURA SOBREPONER

Modelo 750 instalación fácil



CODIGO	REF	MEDIDA/TIPO	UN.	Pza.	PRECIO + IVA
17-26-011	43576	Derecha	3		

TOPE PUERTA



CODIGO	REF	MEDIDA/TIPO	UN.	Pza.	PRECIO + IVA
17-26-096	43641	Latón	6		
17-26-098	43642	Cromo	6		

TOPE PUERTA TIPO CODO



CODIGO	REF	MEDIDA/TIPO	UN.	Pza.	PRECIO + IVA
17-26-100	43771	Latón	6		
17-26-102	43772	Cromo	6		

CERRADURAS POMO

Incluye 2 llaves, excepto baño



- Cilindro metálico
- Perilla y escudo de acero
- vida útil 200.000 ciclos
- Para colocación en puertas con espesor de 1-1/4" a 1-3/4" (32 a 45 mm)



Acabado latón brillante

CODIGO	REF	MEDIDA/TIPO	UN.	Pza.	PRECIO + IVA
17-26-080	23560	Entrada	3		
17-26-082	23563	Dormitorio	3		
17-26-084	23566	Baño	3		



Acabado cromo mate

CODIGO	REF	MEDIDA/TIPO	UN.	Pza.	PRECIO + IVA
17-26-086	23562	Entrada	3		
17-26-088	23565	Dormitorio	3		
17-26-090	23568	Baño	3		



Acabado negro (calidad superior)

Cilindro de latón sólido, 400.000 ciclos.

CODIGO	REF	MEDIDA/TIPO	UN.	Pza.	PRECIO + IVA
17-26-130	47909	Entrada	3		
17-26-132	47910	Dormitorio	3		
17-26-134	47911	Baño	3		

GRATA DE COPA TRENZADA

Alambre grueso

- Para desbaste rápido
- Fabricadas en acero al carbono



ESPECIFICACIONES:			
Medida:	3"	4"	5"
Calibre:	0.5 mm	0.5 mm	0.5 mm
Vel.:	12000 rpm	8500 rpm	6500 rpm
Trenza:	18 mm	26 mm	24 mm

CODIGO	REF	MEDIDA/TIPO	UN.	PRECIO + IVA
17-27-033	17530	3"	Pza. 4	
17-27-034	17532	4"	Pza. 4	
17-27-035	11543	5"	Pza. 4	

GRATA COPA TRENZADA

Alambre fino

Fabricadas en acero al carbono



ESPECIFICACIONES:			
Medida:	3"	4"	
Calibre:	0.35 mm	0.35 mm	
Vel.:	12000 rpm	8500 rpm	
Trenza:	18 mm	26 mm	

CODIGO	REF	MEDIDA/TIPO	UN.	PRECIO + IVA
17-27-060	14184	3"	Pza. 4	
17-27-062	14185	4"	Pza. 4	

SET DE GRATAS

4 piezas

INCLUYE:

- Grata de lija diámetro 3"
- Grata de alambre diámetro 3"
- 2 gratas de copa diámetro 2" y 3/4"



CODIGO	REF	MEDIDA/TIPO	UN.	PRECIO + IVA
17-27-030	11577	-	Set 6	

GRATA DE COPA ONDULADA

Alambre fino

- Para desbaste rápido
- Fabricadas en acero al carbono



ESPECIFICACIONES:			
Medida:	3"	4"	5"
Calibre:	0.30 mm	0.35 mm	0.35 mm
Vel.:	12500 rpm	10000 rpm	6000 rpm
Alambre:	23 mm	27 mm	31 mm

CODIGO	REF	MEDIDA/TIPO	UN.	PRECIO + IVA
17-27-038	14180	3"	Pza. 4	
17-27-039	11532	4"	Pza. 4	
17-27-040	11538	5"	Pza. 4	

GRATA COPA TRENZADA TIPO CÓNICA

Alambre fino

Fabricadas en acero al carbono



ESPECIFICACIONES:			
Medida:	4"	5"	
Calibre:	0.35 mm	0.35 mm	
Vel.:	12500 rpm	10000 rpm	
Trenza:	22 mm	25 mm	

CODIGO	REF	MEDIDA/TIPO	UN.	PRECIO + IVA
17-27-042	14188	4"	Pza. 4	
17-27-044	14189	5"	Pza. 4	

GRATA PARA ESMERIL

Incluye adaptadores

Alambre ondulado para limpieza de superficies

ESPECIFICACIONES:
Calibre: 0.35 mm
Ancho: 1.1/8"
Vel. máx. 6.000 rpm



CODIGO	REF	MEDIDA/TIPO	UN.	PRECIO + IVA
17-27-031	11526	6"	Pza. 4	

GRATA CIRCULAR

Alambre fino

Acero latonado

ESPECIFICACIONES:
Calibre 0.17 mm
Vel. máx. 4.500 rpm



CODIGO	REF	MEDIDA/TIPO	UN.	PRECIO + IVA
17-27-001	11573	1.1/2"	Pza. 6	
17-27-002	11574	2"	Pza. 6	
17-27-003	11575	3"	Pza. 6	
17-27-004	11576	4"	Pza. 6	

GRATA CIRCULAR

Alambre grueso

Acero latonado

ESPECIFICACIONES:
Calibre 0.3 mm
Vel. máx. 4.500 rpm



CODIGO	REF	MEDIDA/TIPO	UN.	PRECIO + IVA
17-27-010	11569	2"	Pza. 6	
17-27-011	11570	3"	Pza. 6	
17-27-012	11590	4"	Pza. 6	

GRATA DE COPA

Alambre fino

Acero latonado

ESPECIFICACIONES:
Calibre 0.17 mm
Vel. máx. 4.500 rpm



CODIGO	REF	MEDIDA/TIPO	UN.	PRECIO + IVA
17-27-018	11591	1.3/4"	Pza. 6	
17-27-019	11592	2.3/4"	Pza. 6	

GRATA DE COPA

Alambre grueso

Acero latonado

ESPECIFICACIONES:
Calibre 0.3 mm
Vel. máx. 4.500 rpm



CODIGO	REF	MEDIDA/TIPO	UN.	PRECIO + IVA
17-27-021	11593	3/4"	Pza. 6	
17-27-022	11595	1"	Pza. 6	
17-27-023	11596	1.1/8"	Pza. 6	
17-27-025	11571	1.3/4"	Pza. 6	
17-27-027	11572	2.3/4"	Pza. 6	

MANDRIL CON LLAVE

Acabado niquelado

Compatible con adaptadores SDS plus y ADAP-PLUS



CODIGO	REF	MEDIDA/TIPO	UN.		PRECIO + IVA
17-27-102	16477	3/8"	Pza.	6	
17-27-103	16478	1/2"	Pza.	6	

LLAVE PARA MANDRIL



CODIGO	REF	MEDIDA/TIPO	UN.		PRECIO + IVA
17-27-098	16559	3/8"	Pza.	6	
17-27-099	16560	1/2"	Pza.	6	

CORTACÍRCULOS BIMETÁLICO

Dientes de acero alta velocidad



Para cortar láminas o placa de acero inoxidable, fundición, aluminio, madera y plásticos



- Aluminio
- Madera
- Plásticos
- Acero

CODIGO	REF	MEDIDA/TIPO	UN.		PRECIO + IVA
17-27-080	18084	9/16"	Pza.	3	
17-27-081	18085	5/8"	Pza.	3	
17-27-082	18086	3/4"	Pza.	3	
17-27-083	18087	7/8"	Pza.	3	
17-27-084	18088	1"	Pza.	3	
17-27-085	18090	1.1/8"	Pza.	3	
17-27-086	18091	1.3/16"	Pza.	3	
17-27-087	18092	1.1/4"	Pza.	3	
17-27-088	18093	1.3/8"	Pza.	3	
17-27-089	18094	1.1/2"	Pza.	3	
17-27-090	18095	1.9/16"	Pza.	3	
17-27-091	18096	1.3/4"	Pza.	3	
17-27-092	18097	2"	Pza.	3	
17-27-093	18098	2.1/8"	Pza.	3	
17-27-094	18099	2.1/4"	Pza.	3	
17-27-095	18118	2.3/8"	Pza.	3	
17-27-096	18119	2.1/2"	Pza.	3	
17-27-097	18120	2.3/4"	Pza.	3	

MANDRIL P/CORTACÍRCULOS BIM.

Acero inoxidable



CODIGO	REF	MEDIDA/TIPO	UN.		PRECIO + IVA
17-27-100	18122	3/8"	Pza.	6	
17-27-101	18123	7/16"	Pza.	6	

CORTACÍRCULOS DIAMANTADO

Borde continuo, para corte en humedo

Para cortes más rápidos y finos sin despostillar



- Loseta y azulejo
- Vidrio
- Mármol
- Porcelanato

CODIGO	REF	MEDIDA/TIPO	UN.		PRECIO + IVA
17-27-120	17124	3/4"	Pza.	4	
17-27-122	17126	1"	Pza.	4	

MANDRIL P/CORTACÍRCULOS DIAMANTADO

Carburo tungsteno



CODIGO	REF	MEDIDA/TIPO	UN.		PRECIO + IVA
17-27-055	18143	1/4"	Pza.	6	
17-27-056	18144	3/8"	Pza.	6	

SET DE PIEDRAS ABRASIVAS

5 piezas, para herramienta multipropósito

Fabricadas en óxido de aluminio
Para acabados y
desbaste de metal

ESPECIFICACIONES
Grano mediano: 60



CODIGO	REF	MEDIDA/TIPO	UN.	PRECIO + IVA
17-27-050	11680	1/4"	Jgo. 6	
17-27-053	102632	1/4" y 1/8"	Jgo. 6	

KIT INSTALACIÓN DE CERRADURAS

3 piezas, para madera y aluminio

Fabricación en acero
de alto carbono

PRETUL



CODIGO	REF	MEDIDA/TIPO	UN.	PRECIO + IVA
17-27-070	23549	3 piezas	Jgo. 6	

JUEGO DE ACCESORIOS MULTIUSOS

11 Piezas, para taladro

PRETUL

- Para limpieza, pulido y
abrillantado de baños,
alfombras, cocinas, rines,
parrillas y tapicería
- Cerdas de polipropileno
- Zanco de 1/4" cambio rápido



Caja máster: 3 Juegos

CODIGO	REF	MEDIDA/TIPO	UN.	PRECIO + IVA
17-27-210	27190	-	Jgo. 1	

SET DE PIEDRAS ALTO RENDIMIENTO

5 piezas, para herramienta multipropósito

Fabricadas en óxido de aluminio
Para desbaste rápido y
rectificado de acero al
carbono y aleados

ESPECIFICACIONES
Grano mediano: 60



CODIGO	REF	MEDIDA/TIPO	UN.	PRECIO + IVA
17-27-052	12444	1/4"	Jgo. 6	

SET DE SIERRAS COPA

5 piezas para madera y aluminio

Fabricación en acero
de alto carbono

PRETUL



CODIGO	REF	MEDIDA/TIPO	UN.	PRECIO + IVA
17-27-075	23550	5 piezas	Set 6	

JUEGO DE ACCESORIOS P/LIMPIEZA

12 Piezas, para taladro

PRETUL

- Para limpieza profunda de baños,
alfombras, cocinas, rines,
parrillas y tapicería
- Cerdas de polipropileno
- Zanco de 1/4" cambio rápido



Caja máster: 3 Juegos

CODIGO	REF	MEDIDA/TIPO	UN.	PRECIO + IVA
17-27-212	27191	-	Jgo. 1	

KIT INSTALACIÓN DE CERRADURAS

4 piezas, para madera y aluminio

- Brocasieras de acero al carbono
- Distancia de perforación: 2 3/8" - 2 3/4"



CODIGO	REF	MEDIDA/TIPO	UN.	PRECIO + IVA
17-27-072	26038	4 piezas	Jgo. 4	

SOPORTE PARA ESMERILADORA ANGULAR

Base de hierro fundido

- Para la mayoría de las esmeriladoras de 4 1/2"
- Cortes angulares de 0 - 45°
- Brazo basculante de fácil ensamble

ESPECIFICACIONES

- Apertura máxima
de prensa: 93 mm
- Cortes angulares: 0 - 45°



(Esmeriladora no incluida)

CODIGO	REF	MEDIDA/TIPO	UN.	PRECIO + IVA
17-27-200	102273	4.1/2"	Pza. 1	

CINTA DE EMPAQUE CAFÉ

Adhesivo acrílico a base de agua

Ideal para polietilenos

ESPECIFICACIONES:
Ancho: 48 mm
Espesor: 0.050 mm



CODIGO	REF	MEDIDA/TIPO	UN.	PRECIO + IVA
17-28-001	12550	40 m	Pza.	12/72

CINTA DE EMPAQUE TRANSPARENTE

Adhesivo acrílico a base de agua

Ideal para polietilenos

ESPECIFICACIONES:
Ancho: 48 mm
Espesor: 0.050 mm



CODIGO	REF	MEDIDA/TIPO	UN.	PRECIO + IVA
17-28-004	12551	40 m	Pza.	12/72
17-28-006	12557	150 m	Pza.	6/60

DISPENSADOR DE CINTA

Incluye 2 rollos de cinta transparente

Para cintas de 48 mm de ancho y máximo 117 mm de diámetro



CODIGO	REF	MEDIDA/TIPO	UN.	PRECIO + IVA
17-28-008	12559	-	Pza.	3

FILM PLÁSTICO PARA EMBALAR

Polietileno de alta elongación y adhesividad

Diámetro interno 3", para uso manual o en máquina



Para empaque y protección de cajas, muebles y artículos generales

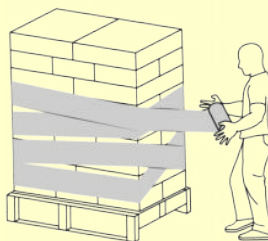

CODIGO	REF	MEDIDA/TIPO	UN.	PRECIO + IVA
17-28-160	101689	45 cm x 244 m	Pza.	4

CINTA PARA DUCTO RESISTENTE

Alta temperatura

- Polietileno reforzado con malla de algodón
- Adhesivo hot melt

ESPECIFICACIONES:
Ancho: 48 mm
Espesor: 0.19 mm
Elongación mín.: 10 %
Temp. máx.: 60° C



CODIGO	REF	MEDIDA/TIPO	UN.	PRECIO + IVA
17-28-012	12586	10 m	Pza.	6/60
17-28-013	12587	30 m	Pza.	4/40
17-28-014	12588	50 m	Pza.	4/40

CINTA PARA DUCTO

Alta temperatura

PRETUL

Adhesivo hot melt

ESPECIFICACIONES:
Ancho: 48 mm
Espesor: 0.16 mm
Elongación mín.: 10 %
Temp. máx.: 60° C



CODIGO	REF	MEDIDA/TIPO	UN.	PRECIO + IVA
17-28-015	20528	10 m	Pza.	6/60
17-28-016	20529	30 m	Pza.	4/40
17-28-017	20530	50 m	Pza.	4/40

CINTA DE ALUMINIO

Protege ductos contra daño por calor

- Adherencia en partes irregulares
- Adhesivo hot melt

ESPECIFICACIONES:
Longitud: 9 m
Ancho: 48 mm
Espesor: 0.085 mm



CODIGO	REF	MEDIDA/TIPO	UN.	PRECIO + IVA
17-28-019	12611	9 m	Pza.	6/36

CINTA DE MONTAJE

Cinta de espuma con doble adhesivo

Se adhiere permanentemente a la mayoría de las superficies



CODIGO	REF	MEDIDA/TIPO	UN.	PRECIO + IVA
17-28-035	11724	19 mm x 1.5 m	Pza. 12	
17-28-038	11725	19 mm x 5 m	Pza. 12	
17-28-042	11727	25 mm x 5 m	Pza. 6	

CUADROS DE MONTAJE

Set 18 cuadros

- Soporta hasta 2 kg
- Para uso en interiores
- Para metal, madera, cerámica
- Se adhiere a la mayoría de las superficies limpias, secas, lisas o rugosas
- Espesor: 1 mm



CODIGO	REF	MEDIDA/TIPO	UN.	PRECIO + IVA
17-28-046	17290	24 x 24 mm	Jgo. 16	

CINTA ANTIDESLIZANTE FOTOLUMINICENTE

Para áreas con poca iluminación

Brilla hasta por 8 horas

ESPECIFICACIONES:

Ancho: 50 mm
Largo: 5 m



CODIGO	REF	MEDIDA/TIPO	UN.	PRECIO + IVA
17-28-033	101450	-	Pza. 3/36	

CINTA ADHESIVA ANTIDESLIZANTE

Rollo de 5 metros

ESPECIFICACIONES:

Ancho: 50 mm
Largo: 5 m



CODIGO	REF	MEDIDA/TIPO	UN.	PRECIO + IVA
17-28-031	12533	transparente	Pza. 6/36	
17-28-032	12532	Negro	Pza. 6/36	

CINTA ADHESIVA ANTIDESLIZANTE

Set de 6 tiras de 23 cm

ESPECIFICACIONES:

Ancho: 50 mm
Largo: 23 cm



Caja máster: 60 Set

CODIGO	REF	MEDIDA/TIPO	UN.	PRECIO + IVA
17-28-025	12531	transparente	Set 5	
17-28-026	12530	negro	Set 5	

BANDA PLÁSTICAS

“PRECAUCIÓN” y “PELIGRO”

Alta resistencia a la fricción

ESPECIFICACIONES:

Espesor: 0.04 mm
Largo: 305 m



CODIGO	REF	MEDIDA/TIPO	UN.	PRECIO + IVA
17-28-048	12583	Precaución	Pza. 3/12	
17-28-050	12585	peligro	Pza. 3/12	

CINTA ADHESIVA DE SEÑALIZACIÓN

Adhesivo acrílico base solvente

ESPECIFICACIONES:

Longitud: 18 m
Ancho: 48 mm
Espesor: 0.105 mm



CODIGO	REF	MEDIDA/TIPO	UN.	PRECIO + IVA
17-28-034	12597	18 m	Pza. 6/36	

MANGUERA TIPO RESORTE

Para compresor

Conexión macho de latón de 1/4 NPT
Longitud 15.2 m

- Presión máxima: 200 PSI



Caja máster: 20 unidades

CODIGO	REF	MEDIDA/TIPO	UN.	PRECIO + IVA
17-29-001	19075	1/4" x 15,2 m	Pza. 2	

PISTOLA METÁLICA PARA SOPLETEAR

Incluye adaptador para válvula y boquilla



CODIGO	REF	MEDIDA/TIPO	UN.	PRECIO + IVA
17-29-005	19023	1/4 NPT	Pza. 6	

JUEGO PARA COMPRESOR DE AIRE

18 piezas en estuche plástico

CONTENIDO

- 1 Pistola de aire
- 1 Adaptador para válvula (latón)
- 1 Válvula diagonal (latón)
- 2 Pivotes
- 1 Inflador punta espiga (latón)
- 1 Cepillo escobillón (base de latón)
- 1 Válvula para inflar balones
- 1 Calibrador de presión
- 1 Reparador de válvula
- 1 Niple tipo "MM" de 1/4"
- 1 Boquilla aspersiona
- 1 Boquilla cónica de latón con plástico
- 1 Conector rápido tipo "M" (macho, latón)
- 1 Conector rápido tipo "F" (hembra, latón)
- 1 Inflador cabeza doble (hembra, cuerpo de latón)
- 1 Boquilla de punta alta presión
- 1 Cople rápido tipo "F" (hembra, latón)



CODIGO	REF	MEDIDA/TIPO	UN.	PRECIO + IVA
17-29-012	19079	1/4 NPT	Jgo. 3	

CONECTOR RÁPIDO DE LATÓN

Para compresor 1/4" NPT



CODIGO	REF	MEDIDA/TIPO	UN.	PRECIO + IVA
17-29-016	19082	Hembra	Pza. 6	
17-29-017	19083	Macho	Pza. 6	

COPLA LATÓN

Para compresor de 1/4" NPT



CODIGO	REF	MEDIDA/TIPO	UN.	PRECIO + IVA
17-29-020	19084	Hembra	Pza. 6	
17-29-021	19085	Macho	Pza. 6	

MANGUERA PARA COMPRESOR

Fabricada en hule, para uso rudo

- Mayor resistencia a la abrasión
- Conector móvil
- Recomendadas para herramientas neumáticas

ESPECIFICACIONES:
Pres. máx. 300 PSI
Conector 1/4" NPT



Refuerzo para evitar rupturas y reducir desgaste

CODIGO	REF	MEDIDA/TIPO	UN.	PRECIO + IVA
17-29-100	17081	1/4"x15 m	Pza. 3	

MANGUERA COMPRESOR

PVC 100% virgen

- Conector móvil de latón
- Recomendada para herramientas neumáticas

ESPECIFICACIONES:
Pres. máx. 300 PSI
Conector 1/4" NPT



CODIGO	REF	MEDIDA/TIPO	UN.	PRECIO + IVA
17-29-104	19014	1/4" x 10 m	Pza. 3	

CLAVADORA NEUMÁTICA

Para clavos hasta 2"

Uso en mueblería y carpintería en general
En maleta plástica resistente

ESPECIFICACIONES:

Capacidad de 100 clavos
Clavos: calibre 18 de 3/8" a 2" (10 – 50 mm)
Presión de trabajo: 75-110 PSI
Peso: 1.5 kg
Ciclo de trabajo: continuo (lubrique constantemente)

Incluye: aceite lubricante, conector 1/4 NPT y 2 llaves allen

No incluye clavos



Caja máster: 5 unidades

CODIGO	REF	MEDIDA/TIPO	UN.	PRECIO + IVA
17-29-110	13180	-	Pza. 1	

CLAVOS PARA CLAVADORA NEUMÁTICA

Calibre 18, caja 5000 unidades

Este artículo también lo puede encontrar en la sección de Quincallería y fijaciones

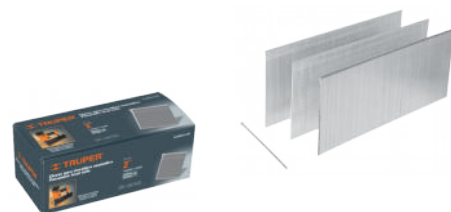

CODIGO	REF	MEDIDA/TIPO	UN.	PRECIO + IVA
17-29-111	18261	5/8"	Cja. 1	
17-29-113	18263	1"	Cja. 1	
17-29-116	18267	1.5/8"	Cja. 1	

LIMA PLANA

Con mango

- Mango de doble inyección
- Para limado y acabados de metales



CODIGO	REF	MEDIDA/TIPO	UN.	PRECIO + IVA
17-30-053	15311	8"	Pza. 6	

LIMA TRIANGULAR, BASTARDA

- Dureza y geometría homogénea en el corte
- Para limar sierras con dientes de 60°



CODIGO	REF	MEDIDA/TIPO	UN.	PRECIO + IVA
17-30-070	15125	8"	Pza. 6	

ESCOFINA PARA HERRAR

- Para herrar cascos de caballo
- Gran capacidad de desbaste
- Cantos picados

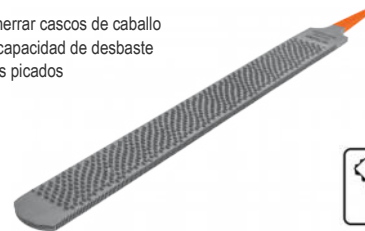

CODIGO	REF	MEDIDA/TIPO	UN.	PRECIO + IVA
17-30-110	15208	14"	Pza. 6	

LIMA REDONDA

Con mango

- Mango de doble inyección
- Para dar forma a orificios o curvas



CODIGO	REF	MEDIDA/TIPO	UN.	PRECIO + IVA
17-30-056	15316	8"	Pza. 6	

LIMA PLANA, BASTARDA

Para limado y acabados de metales

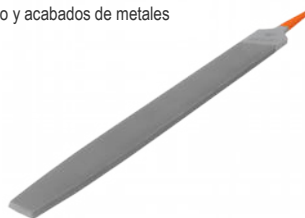

CODIGO	REF	MEDIDA/TIPO	UN.	PRECIO + IVA
17-30-080	15142	8"	Pza. 6	
17-30-081	15144	10"	Pza. 6	

LIMA PLANA MUZA

- Corte doble para desbaste rápido
- Para acabados finos

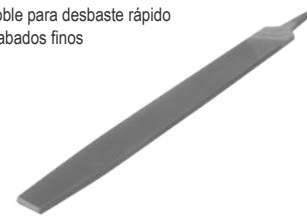

CODIGO	REF	MEDIDA/TIPO	UN.	PRECIO + IVA
17-30-120	15155	8"	Pza. 6	
17-30-122	15157	10"	Pza. 6	

ESCOFINA

Con mango

- Mango de doble inyección
- Para desbastar madera



CODIGO	REF	MEDIDA/TIPO	UN.	PRECIO + IVA
17-30-060	15321	8"	Pza. 6	

LIMA REDONDA, BASTARDA

Para dar forma a orificios o curvas

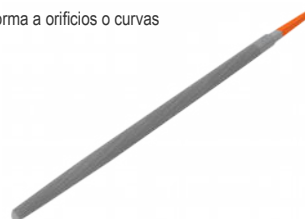

CODIGO	REF	MEDIDA/TIPO	UN.	PRECIO + IVA
17-30-090	15189	8"	Pza. 6	
17-30-091	15191	10"	Pza. 6	

LIMA REDONDA MUZA

Para dar forma a orificios o curvas



CODIGO	REF	MEDIDA/TIPO	UN.	PRECIO + IVA
17-30-130	15197	8"	Pza. 6	
17-30-132	15199	10"	Pza. 6	

ESCOFINA, BASTARDA

Para dar forma a orificios o curvas



CODIGO	REF	MEDIDA/TIPO	UN.	PRECIO + IVA
17-30-100	15205	8"	Pza. 6	
17-30-101	15207	10"	Pza. 6	

LIMA PARA MOTOSIERRA

Largo de 8"

Para afilar y mantener la forma de los dientes de las cadenas para motosierras

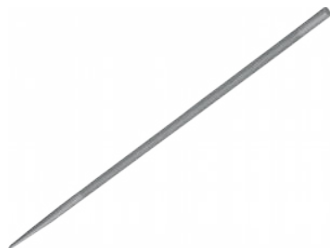

CODIGO	REF	MEDIDA/TIPO	UN.	PRECIO + IVA
17-30-003	15166	3/16"	Pza. 12	
17-30-005	15168	7/32"	Pza. 12	

SET DE LIMAS PARA JOYERO

10 piezas

CONTENIDO

- Plana cuadrada
- Plana en punta
- Media caña
- Triangular
- Tipo espada
- Ovalada
- Redonda
- Cuadrada
- Tipo almendra
- Tipo cuchillo



CODIGO	REF	MEDIDA/TIPO	UN.	PRECIO + IVA
17-30-031	15239	6.1/4"	Jgo. 6	

PIEDRA PARA GUADAÑA

Carburo de silicio

- Para afilado y biselado de machetes, hachas, guadañas, etc.
- grano grueso para afilar y remover imperfecciones

ESPECIFICACIONES:

Granos: 150
Espesor: 5/8"



CODIGO	REF	MEDIDA/TIPO	UN.	PRECIO + IVA
17-30-206	11669	230 x 35 mm	Pza. 6	

PIEDRA PARA ASENTAR

Carburo de silicio, doble grano

- Grano fino para asentar
- Grano grueso para afilar y remover imperfecciones

ESPECIFICACIONES:

Granos: 150 / 240
Espesor: 1"

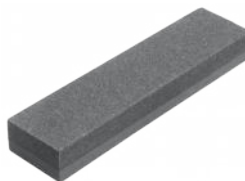

CODIGO	REF	MEDIDA/TIPO	UN.	PRECIO + IVA
17-30-200	11667	150 mm	Pza. 6	
17-30-202	11668	200 mm	Pza. 6	

LIJAS PARA MADERA

Cajas de 25 unidades

- Papel kraft
- Para usarse a mano o en máquina
- Para madera, lacas y pintura
- Fabricada en oxido de aluminio



CODIGO	REF	MEDIDA/TIPO	UN.	PRECIO + IVA
17-30-250	11615	9" x 11" / G60	Pza. 25	
17-30-252	11616	9" x 11" / G100	Pza. 25	
17-30-254	11617	9" x 11" / G150	Pza. 25	

LIJAS AL AGUA

Cajas de 25 unidades

- Papel impermeable
- Para usarse a mano o en máquina
- Para plástico, lacas y pintura, vidrio y metal ferroso y no ferroso
- Fabricada en carburo de silicio



CODIGO	REF	MEDIDA/TIPO	UN.	PRECIO + IVA
17-30-260	11646	9" x 11" / G60	Pza. 25	
17-30-262	11618	9" x 11" / G80	Pza. 25	
17-30-264	11619	9" x 11" / G100	Pza. 25	
17-30-266	11620	9" x 11" / G120	Pza. 25	
17-30-268	11621	9" x 11" / G150	Pza. 25	
17-30-270	11622	9" x 11" / G180	Pza. 25	
17-30-272	11623	9" x 11" / G220	Pza. 25	
17-30-274	11624	9" x 11" / G240	Pza. 25	

LIJAS DE TELA PARA METAL

Cajas de 25 unidades

- Para usarse a mano o en máquina
- Para lacas, pintura, metal ferroso y no ferroso
- Fabricada en oxido de aluminio



CODIGO	REF	MEDIDA/TIPO	UN.	PRECIO + IVA
17-30-282	11602	9" x 11" / G80	Pza. 25	
17-30-286	11603	9" x 11" / G120	Pza. 25	

PALA REDONDA CON MANGO
19.1/2" x 8.1/4"



CODIGO	REF	LARGO	UN.	PRECIO + IVA
17-31-025	17160	Fig.1 40.1/2"	Pza. 3	
17-31-028	17175	Fig.2 56"	Pza. 3	

PALA RECTA CON MANGO
21" x 7"



CODIGO	REF	LARGO	UN.	PRECIO + IVA
17-31-014	17162	Fig.1 41.1/2"	Pza. 3	
17-31-018	17226	Fig.2 59.1/4"	Pza. 3	

PALA REDONDA MANGO FIBRA VIDRIO
20" x 8.3/4"

TRU PRO



CODIGO	REF	LARGO	UN.	PRECIO + IVA
17-31-024	17150	40"	Pza. 3	

PALA CARBONERA CON MANGO
22.7/8" x 12.1/4"



CODIGO	REF	LARGO	UN.	PRECIO + IVA
17-31-010	17164	43.1/2"	Pza. 3	

PALA CUADRADA CON MANGO
19.3/4" x 9.5/8"



CODIGO	REF	LARGO	UN.	PRECIO + IVA
17-31-050	17161	Fig.1 40.3/4"	Pza. 3	
17-31-051	17176	Fig.2 56.1/4"	Pza. 3	

PALA CARBONERA MANGO FIBRA VIDRIO
22.7/8 X 12.1/4"

TRU PRO



CODIGO	REF	LARGO	UN.	PRECIO + IVA
17-31-011	17153	41.3/4"	Pza. 3	

PALA ALARGADA CON MANGO
24" x 5.1/2"

Mango "Y"



CODIGO	REF	LARGO	UN.	PRECIO + IVA
17-31-030	17163	44.1/4"	Pza. 3	

PALA PUNTA HUEVO CON MANGO
20.3/8" x 11.1/2"

Mango "Y"



CODIGO	REF	LARGO	UN.	PRECIO + IVA
17-31-026	17165	42"	Pza. 3	

PALA CAJUELERA REDONDA
14.3/4" x 5.3/4"

Mango "Y"



CODIGO	REF	LARGO	UN.	PRECIO + IVA
17-31-033	17193	27"	Pza. 3	

PALA REDONDA CLASSIC M/MADERA
19.3/8 x 8.1/4"

Mango largo



CODIGO	REF	LARGO	UN.	PRECIO + IVA
17-31-027	17169	57.1/2"	Pza. 3	

PALA SANITARIA CAB/ALUMINIO
23.1/2" x 13"

Mango "Y"



CODIGO	REF	LARGO	UN.	PRECIO + IVA
17-31-040	17181	44.1/2"	Pza. 3	

PALA REDONDA #4 SIN MANGO
13.1/4" x 8"



CODIGO	REF	LARGO	UN.	PRECIO + IVA
17-31-043	19666	-	Pza. 3	

ALICATE ELECTRICISTA PRO
Acero CrV, mangos comfort grip



CODIGO	REF	MEDIDA/TIPO	UN.	PRECIO + IVA
17-32-014	17338	7"	Pza. 3	
17-32-016	12350	8"	Pza. 3	

ALICATE ELECTRICISTA
Acero CrV, mangos comfort grip



CODIGO	REF	MEDIDA/TIPO	UN.	PRECIO + IVA
17-32-018	17329	7"	Pza. 6	
17-32-020	17330	8"	Pza. 6	

ALICATE PUNTA Y CORTE
Acero CrV, mangos comfort grip



CODIGO	REF	MEDIDA/TIPO	UN.	PRECIO + IVA
17-32-022	17334	6"	Pza. 6	
17-32-024	17336	8"	Pza. 6	

ALICATE PUNTA CURVA
Acero CrV, mangos comfort grip



CODIGO	REF	MEDIDA/TIPO	UN.	PRECIO + IVA
17-32-026	17337	6"	Pza. 6	

ALICATE CORTE DIAGONAL
Acero CrV, mangos comfort grip



CODIGO	REF	MEDIDA/TIPO	UN.	PRECIO + IVA
17-32-028	17331	6"	Pza. 6	

ALICATE ELECTRICISTA PROFESIONAL
Acero CrV, mangos vinil



CODIGO	REF	MEDIDA/TIPO	UN.	PRECIO + IVA
17-32-011	17303	7"	Pza. 3	
17-32-012	17304	8"	Pza. 3	
17-32-010	17305	9"	Pza. 3	

ALICATE CORTE DIAGONAL
Acero CrV, mangos vinil



CODIGO	REF	MEDIDA/TIPO	UN.	PRECIO + IVA
17-32-030	17312	6"	Pza. 6	

ALICATE PUNTA
Acero CrV, mangos vinil



CODIGO	REF	MEDIDA/TIPO	UN.	PRECIO + IVA
17-32-040	17309	6"	Pza. 3	
17-32-042	17310	8"	Pza. 3	

ALICATE ELECTRICISTA PRETUL®
Acero al carbono, mangos comfort grip



CODIGO	REF	MEDIDA/TIPO	UN.	PRECIO + IVA
17-32-202	22676	7"	Pza. 6	
17-32-203	22674	8"	Pza. 6	

ALICATE DE PUNTA PRETUL®
Acero al carbono, mangos comfort grip



CODIGO	REF	MEDIDA/TIPO	UN.	PRECIO + IVA
17-32-205	22670	6"	Pza. 6	

ALICATE CORTE DIAGONAL PRETUL®
Acero al carbono, mangos comfort grip



CODIGO	REF	MEDIDA/TIPO	UN.	PRECIO + IVA
17-32-209	22675	6"	Pza. 6	
17-32-210	22678	7"	Pza. 6	

SET DE ALICATES Y LLAVE PRETUL®
5 Piezas, en display

- INCLUYE:
- Alicate mecánico 8"
 - Alicate electricista 8"
 - Alicate punta 6"
 - Caimán 10"
 - Llave francesa 8"



Caja máster: 4 juegos

CODIGO	REF	MEDIDA/TIPO	UN.	PRECIO + IVA
17-32-215	22971	-	Set 1	

ALICATE BOMBA DE AGUA

Acero al carbono, mangos de PVC



CODIGO	REF	MEDIDA/TIPO	UN.		PRECIO + IVA
17-32-007	17350	8"	Pza.	3	
17-32-008	17351	10"	Pza.	3	
17-32-009	17352	12"	Pza.	3	

TENAZA

Acero al carbono, mangos de PVC

Para amarre y corte de alambre en estructuras metálicas



CODIGO	REF	MEDIDA/TIPO	UN.		PRECIO + IVA
17-32-120	17381	8"	Pza.	3	

TENAZA PARA AZULEJOS

Dientes de carburo de tungsteno

- Ideal para cortes difíciles y eliminar sobrante de azulejo
- Resorte de auto-apertura



CODIGO	REF	MEDIDA/TIPO	UN.		PRECIO + IVA
17-32-002	17382	8"	Pza.	3	

CORTA PERNOS

Cuchilla de acero CrMo

Mecanismo que permite realizar mas palanca con menor esfuerzo



Caja máster: 2 un.

CODIGO	REF	MEDIDA/TIPO	UN.		PRECIO + IVA
17-32-140	12830	12"	Pza.	1	
17-32-142	12831	14"	Pza.	1	
17-32-144	12832	18"	Pza.	1	
17-32-146	12833	24"	Pza.	1	

CAIMÁN RECTO

Mordazas de acero CrMo, mangos vinil



Entrada para llave allen



CODIGO	REF	MEDIDA/TIPO	UN.		PRECIO + IVA
17-32-050	17437	10"	Pza.	3	

CAIMÁN CURVO

Mordazas de acero CrMo, mangos vinil



Entrada para llave allen



CODIGO	REF	MEDIDA/TIPO	UN.		PRECIO + IVA
17-32-052	17436	10"	Pza.	3	

CAIMÁN RECTO

Mordazas de acero CrMo



Entrada para llave allen



CODIGO	REF	MEDIDA/TIPO	UN.		PRECIO + IVA
17-32-066	17424	10"	Pza.	3	

CAIMÁN CURVO

Mordazas de acero CrMo



Entrada para llave allen



CODIGO	REF	MEDIDA/TIPO	UN.		PRECIO + IVA
17-32-060	17423	10"	Pza.	3	

CAIMÁN CADENA

Longitud cadena 50 cm

Cadena fabricada en acero carbono



CODIGO	REF	MEDIDA/TIPO	UN.		PRECIO + IVA
17-32-070	17438	8"	Pza.	3	

CAIMÁN HOJALATERO

Acero al carbono

Para soldadura de tubos y placas de lámina, materiales tirados y angulados
Entrada para llave allen



CODIGO	REF	MEDIDA/TIPO	UN.		PRECIO + IVA
17-32-062	17425	PPP-8"	Pza.	3	

CAIMÁN SOLDADOR

Acero al carbono

Para soldadura de vigas, perfiles en "T", barras, tubos, etc.
Entrada para llave allen



CODIGO	REF	MEDIDA/TIPO	UN.		PRECIO + IVA
17-32-064	17426	PPS-9"	Pza.	3	

MULTIHERRAMIENTA
13 funciones, con estuche

- Acero inoxidable
- En display con estuche al reverso



Caja máster: 4 unidades



CODIGO	REF	MEDIDA/TIPO	UN.	PRECIO + IVA
17-32-130	24105	-	Pza. 1	

PRETUL® PELACABLES AUTOMÁTICO

Capacidad para cables de 22 a 10 AWG

- Cuchillas para corte de cable
- Mordazas para crimpar
- Tope medidor de longitud



CODIGO	REF	MEDIDA/TIPO	UN.	PRECIO + IVA
17-32-090	17360	8"	Pza. 3	

ALICATE PARA ANILLOS

Con 4 cabezas intercambiables

- Fabricada en acero al carbono, con mango confort grip
- Puntas de 180°- 180°- 45°- 90° con diámetro de 1.22 mm
- Para anillos de retención internos o externos



CODIGO	REF	MEDIDA/TIPO	UN.	PRECIO + IVA
17-32-089	17355	6"	Pza. 6	

PELACABLES

Acabado niquelado resistente a la corrosión

- Calibres 20 a 10 AWG
- 6 medidas distintas con 10 mordazas para crimpar



CODIGO	REF	MEDIDA/TIPO	UN.	PRECIO + IVA
17-32-093	17358	10"	Pza. 6	

ALICATE DE PUNTA 90°

Para abrir anillos



CODIGO	REF	MEDIDA/TIPO	UN.	PRECIO + IVA
17-32-086	17364	170 mm	Pza. 6	

ALICATE DE PUNTA 90°

Para cerrar anillos



CODIGO	REF	MEDIDA/TIPO	UN.	PRECIO + IVA
17-32-088	17362	170 mm	Pza. 6	

ALICATE SACABOCADOS

Para perforación en cuero, lona, plástico y cartón.

Diámetros de perforación:
2, 2.5, 3, 3.5, 4, 4.5 mm



CODIGO	REF	MEDIDA/TIPO	UN.	PRECIO + IVA
17-32-076	17340	9"	Pza. 3	

MARTILLO CARPINTERO

Mango fibra de vidrio

- Mango antivibraciones
- Cabeza totalmente pulida con alojamiento imantado para clavos



CODIGO	REF	MEDIDA/TIPO	UN.		PRECIO + IVA
17-33-009	19710	16 oz / 13"	Pza.	4	

MARTILLO CARPINTERO DE UNA PIEZA

Revestido de neopreno

- Mango revestido de neopreno que reduce las vibraciones del golpe
- Cabeza y mango totalmente pulidos con alojamiento imantado para clavos



CODIGO	REF	MEDIDA/TIPO	UN.		PRECIO + IVA
17-33-056	16820	20 oz / 14"	Pza.	4	

MARTILLO TAPICERO

Mango madera hickory americano

- Extremo imantado para sostener clavos y tachuelas.
- Mango con grabado láser antiderrapante



CODIGO	REF	MEDIDA/TIPO	UN.		PRECIO + IVA
17-33-039	16860	7 oz	Pza.	4	

MARTILLO CARPINTERO

Mango madera hickory americano

Mango con grabado láser antiderrapante



CODIGO	REF	MEDIDA/TIPO	UN.		PRECIO + IVA
17-33-001	16650	7 oz / 11"	Pza.	4	
17-33-003	16654	16 oz / 13"	Pza.	4	
17-33-005	16656	20 oz / 13"	Pza.	4	

MARTILLO MECÁNICO

Mango madera hickory americano

Mango con grip antiderrapante



CODIGO	REF	MEDIDA/TIPO	UN.		PRECIO + IVA
17-33-025	16900	8 oz / 12"	Pza.	4	
17-33-027	16901	12 oz / 14"	Pza.	4	
17-33-029	16902	16 oz / 14"	Pza.	4	
17-33-031	16903	24 oz / 15"	Pza.	4	

MARTILLO DESABOLLADOR

Punta larga

Mango con grabado láser antiderrapante



CODIGO	REF	MEDIDA/TIPO	UN.		PRECIO + IVA
17-33-041	16872	11 oz	Pza.	4	

MARTILLO CARPINTERO CABEZA CÓNICA

Mango madera hickory americano

Mango con grabado láser antiderrapante



CODIGO	REF	MEDIDA/TIPO	UN.		PRECIO + IVA
17-33-013	10558	25 mm - 14 oz	Pza.	6	
17-33-014	10560	27 mm - 16 oz	Pza.	6	
17-33-015	10561	29 mm - 20 oz	Pza.	6	

MAZO DE HULE

Mango madera hickory americano

- Cabeza blanca 100% hule virgen, no ensucia ni daña las superficies de trabajo
- Mango con grabado láser antiderrapante



CODIGO	REF	MEDIDA/TIPO	UN.		PRECIO + IVA
17-33-066	16931	16 oz	Pza.	4	
17-33-068	16932	24 oz	Pza.	4	

MARTILLO DESABOLLADOR

Punta fina de bola

Mango con grabado láser antiderrapante



CODIGO	REF	MEDIDA/TIPO	UN.		PRECIO + IVA
17-33-043	16865	11 oz	Pza.	4	

ATORNILLADOR PLANO
Mango comfort grip

- Acero cromo vanadio
- Puntas magnetizadas
- Barra hexagonal



Planos



CODIGO	REF	MEDIDA/TIPO	UN.		PRECIO + IVA
17-34-040	13992	3/16" x 4"	Pza.	6	
17-34-042	13998	1/4" x 4"	Pza.	6	
17-34-046	14000	1/4" x 6"	Pza.	6	
17-34-048	14006	5/16" x 6"	Pza.	6	

ATORNILLADOR CRUZ
Mango comfort grip

- Acero cromo vanadio
- Puntas magnetizadas
- Barra hexagonal



De Cruz



CODIGO	REF	MEDIDA/TIPO	UN.		PRECIO + IVA
17-34-050	14055	PH0 x 4"	Pza.	6	
17-34-052	14067	PH1 x 6"	Pza.	6	
17-34-054	14079	PH2 x 6"	Pza.	6	

SET DE 7 ATORNILLADORES DIELECTRICOS
Incluye probador de voltaje

- Acero cromo vanadio
- Puntas magnetizadas
- 1000 V



CONTENIDO:
4 Atornilladores planos:
1/8" x 4"
5/32" x 4"
7/32" x 5"
1/4" x 6"
2 atornilladores philips:
PH1 x 3"
PH2 x 4"
1 probador de corriente



CODIGO	REF	MEDIDA/TIPO	UN.		PRECIO + IVA
17-34-003	14196	-	Set	1	

SET DE 5 ATORNILLADORES
Mango comfort grip

- Acero cromo vanadio
- Puntas magnetizadas

1/4" x 6"	3/16" x 4"	3/16" x 3"
3/16" x 4"	-	1/4" x 4"

CONTENIDO:
3 punta plana
2 punta phillip



CODIGO	REF	MEDIDA/TIPO	UN.		PRECIO + IVA
17-34-001	14138	-	Set	6	

SET DE 4 ATORNILLADORES
Mango comfort grip

PRETUL

Puntas magnetizadas

CONTENIDO:
2 punta plana
2 punta phillip

3/16" x 4"	3/16" x 4"
1/4" x 4"	1/4" x 4"



CODIGO	REF	MEDIDA/TIPO	UN.		PRECIO + IVA
17-34-005	20218	-	Set	6	

ATORNILLADOR CON MATRACA
12 puntas

- Puntas de acero cromo vanadio
- Compartimiento giratorio

CONTENIDO:

- 2 Planas de 3/16" a 1/4"
- 4 Phillips de PH0 a PH3
- 6 Torx de T10 a T40









CODIGO	REF	MEDIDA/TIPO	UN.		PRECIO + IVA
17-34-023	18193	-	Pza.	12	

JUEGO ATORNILLADOR DE JOYERO
30 puntas y extensión

- Puntas de acero cromo vanadio
- Mango aluminio con cabeza giratoria

PUNTAS







	9 Planas 0.7 a 4 mm		5 Torx con seguro T7 a T15
	4 Phillips PH000 a PH1		8 Hexagonales 0.7 a 4 mm
	3 Torx T4 a T6		1 Estrella 0.8 mm



CODIGO	REF	MEDIDA/TIPO	UN.	PRECIO + IVA
17-34-013	14162	-	Jgo. 3	

JUEGO DADOS 39 PZAS.
En estuche plástico

CONTENIDO

	Dados 6 puntas (13) 4 a 13 mm (13) 5/32" a 17/32" (4) 14 a 17 mm (2) 9/16" y 5/8"	32		Extensión 3/8" x 3"	1
	Dados 8 puntas 1/4" a 3/8"	3		Matraca	1
				Disco giratorio	1
				Adaptador 3/8" x 1/4"	1



CODIGO	REF	MEDIDA/TIPO	UN.	PRECIO + IVA
17-34-032	23969	-	Jgo. 2	

PRETUL® JUEGO ATORNILLADOR 81 PZAS.
En estuche plástico

CONTENIDO

	Dados (10) 4 a 13 mm, (10) 5/32" a 1/2"	20
	Adaptador	1
	Puntas phillips PH0 a PH3	17
	Puntas hexagonales 1/8" a 1/4"	10
	Puntas planas 1/8" a 9/32"	18
	Puntas torx T10 a T40	14
	Desarmador tipo matraca	1



CODIGO	REF	MEDIDA/TIPO	UN.	PRECIO + IVA
17-34-009	23972	-	Jgo. 2	

SET ATORNILLADORES JOYERO
6 puntas

- Puntas de acero cromo vanadio
- Cabeza giratoria

	1,4mm a 3mm
	#000 a #1



CODIGO	REF	MEDIDA/TIPO	UN.	PRECIO + IVA
17-34-021	21381	-	Set 4	

JUEGO ATORNILLADOR 39 PZAS.
En estuche plástico

Incluye 4 organizadores para puntas

CONTENIDO

	Dados 4 a 14 mm	14		Puntas hexagonales H3 a H6	5
	Puntas planas 3 a 7 mm	6		Adaptador	1
	Puntas phillips PH0 a PH3	6		Desarmador tipo matraca	1
	Puntas torx T10 a T30	6			



CODIGO	REF	MEDIDA/TIPO	UN.	PRECIO + IVA
17-34-030	23971	-	Jgo. 2	

JUEGO DE PUNTAS PHILLIPS
5 piezas, estuche reutilizable

Fabricadas en acero S2, 2X más resistentes al desgaste que las de acero al cromo vanadio

MEDIDAS
1/4" x 50 mm



CODIGO	REF	MEDIDA/TIPO	UN.	PRECIO + IVA
17-34-070	12144	PH0	Jgo. 6	
17-34-075	12146	PH1	Jgo. 6	
17-34-080	12147	PH2	Jgo. 6	
17-34-085	12149	PH3	Jgo. 6	

BANDOLA DESTORCEDORA
Cuerpo metálico

FIERO



CODIGO	REF	MEDIDA / CARGA	UN.	PRECIO + IVA
17-35-001	44029	2" - 7/16" / 70 Kg	Pza	12
17-35-003	44030	3" - 7/16" / 100 Kg	Pza	12
17-35-005	44031	3.1/2" - 5/8" / 100 Kg	Pza	12
17-35-007	44032	4" - 7/8" / 110 Kg	Pza	12
17-35-009	44033	4.1/4" - 3/4" / 190 Kg	Pza	12

BANDOLA CON SEGURO
Fabricada en acero

FIERO



CODIGO	REF	MEDIDA / CARGA	UN.	PRECIO + IVA
17-35-015	44020	1.1/2" - 1/8" / 100kg	Pza	12
17-35-017	44021	2" - 3/16" / 300 kg	Pza	12
17-35-019	44022	2.1/2" - 1/4" / 400 kg	Pza	12
17-35-021	44023	3" - 5/16" / 800 kg	Pza	12
17-35-023	44024	3.1/2" - 3/8" / 1200 kg	Pza	12
17-35-025	44025	4" - 1/2" / 1500 kg	Pza	12

BANDOLA MOSQUETÓN
Fabricada en acero

FIERO



CODIGO	REF	MEDIDA / CARGA	UN.	PRECIO + IVA
17-35-031	44037	2" - 3/16" / 100 kg	Pza	12
17-35-032	44038	2.1/2" - 1/4" / 120 kg	Pza	12
17-35-033	44039	3" - 5/16" / 230 kg	Pza	12
17-35-034	44040	4" - 3/8" / 350 kg	Pza	12
17-35-035	44041	5.1/2" - 1/2" / 540 kg	Pza	12

POLEA
Acabado niquelado

FIERO



CODIGO	REF	MEDIDA / CARGA	UN.	PRECIO + IVA
17-35-050	44113	3/4" / 50 kg	Pza	12
17-35-051	44114	1" / 50 kg	Pza	12
17-35-052	44115	1.1/2" / 75 kg	Pza	12
17-35-053	44116	2" / 90 kg	Pza	12

NUDO PARA CABLE
Hierro maleable, acabado galvanizado

FIERO



CODIGO	REF	MEDIDA	UN.	PRECIO + IVA
SET 2 PIEZAS				
17-35-040	44082	1/8"	Set 2	12
17-35-041	44083	3/16"	Set 2	12
17-35-042	44084	1/4"	Set 2	12
17-35-043	44085	5/16"	Set 2	12
UNIDAD				
17-35-044	44086	3/8"	Pza.	6
17-35-045	44087	1/2"	Pza.	6

GANCHO "S" PARA CABLE
Fabricado en acero, acabado galvanizado

FIERO



CODIGO	REF	MEDIDA / CARGA	UN.	PRECIO + IVA
17-35-098	44091	3/16" / 13 kg	Pza	12
17-35-099	44092	1/4" / 38 kg	Pza	12
17-35-100	44093	5/16" / 75 kg	Pza	12

TENSOR GANCHO-GANCHO
Ganchos de acero, acabado galvanizado

FIERO



CODIGO	REF	MEDIDA / CARGA	UN.	PRECIO + IVA
17-35-064	44060	3/16" / 41 kg	Pza.	6

TENSOR GANCHO-ARGOLLA
Argolla y gancho de acero, acabado galvanizado

FIERO



CODIGO	REF	MEDIDA / CARGA	UN.	PRECIO + IVA
17-35-058	44053	3/16" / 41 kg	Pza	6
17-35-059	44054	1/4" / 50 kg	Pza	6
17-35-060	44055	5/16" / 100 kg	Pza	6
17-35-061	44056	3/8" / 204 kg	Pza	6
Cuerpo de acero al carbono, acabado galvanizado				
17-35-250	44067	1/2" / 680 kg	Pza.	2
17-35-252	44068	5/8" / 1.000 kg	Pza.	2
17-35-254	44069	3/4" / 1.300 kg	Pza.	2
17-35-256	44070	7/8" / 1800 kg	Pza.	2
17-35-258	44071	1" / 2.250 kg	Pza.	1

GANCHO ESLINGA FORJADO
Fabricado en acero, acabado galvanizado

FIERO



CODIGO	REF	MEDIDA / CARGA	UN.	PRECIO + IVA
17-35-080	44075	3/4" / 500 kg	Pza	4
17-35-081	44076	5/8" / 1000 kg	Pza	4
17-35-082	44077	5/8" / 1500 kg	Pza	4
17-35-083	44078	5/8" / 2000 kg	Pza	4

DESTORCEDOR PARA CABLE

Cuerpo metálico



CODIGO	REF	MEDIDA / CARGA	UN.	PRECIO + IVA
17-35-070	44097	1/8" / 27 kg	Pza	12
17-35-071	44098	5/32" / 40 kg	Pza	12
17-35-072	44099	3/16" / 68 kg	Pza	12
17-35-073	44100	1/4" / 68 kg	Pza	12
17-35-074	44101	5/16" / 68 kg	Pza	12

GRILLETES FORJADOS

Acabado galvanizado



CODIGO	REF	MEDIDA / CARGA	UN.	PRECIO + IVA
17-35-142	44967	1/4" / 500 kg	Pza	4
17-35-146	44969	3/8" / 910 kg	Pza	4
17-35-150	44971	1/2" / 1810 kg	Pza	4

DESTORCEDOR FORJADO

Fabricado en acero, acabado galvanizado



CODIGO	REF	MEDIDA / CARGA	UN.	PRECIO + IVA
17-35-088	44105	3/16" / 350 kg	Pza	4
17-35-089	44106	1/4" / 390 kg	Pza	4
17-35-090	44107	5/16" / 570 kg	Pza	4
17-35-091	44108	3/8" / 1020 kg	Pza	4
17-35-092	44109	1/2" / 1630 kg	Pza	4

GUARDACABO PARA CABLE

Fabricado en acero, acabado galvanizado



Protegen contra el desgaste y deformación del cable, alargando su vida útil



CODIGO	REF	MEDIDAS A, B, Ø	UN.	PRECIO + IVA
17-35-220	49908	35 x 22mm / Ø1/8"	Bolsa 10	10
17-35-222	49909	35 x 22mm / Ø3/16"	Bolsa 10	10
17-35-224	49911	38 x 22mm / Ø1/4"	Bolsa 10	10
17-35-226	49912	40 x 25mm / Ø5/16"	Bolsa 5	10
17-35-228	49913	45 x 28mm / Ø3/8"	Bolsa 5	10
17-35-230	49918	49 x 33mm / Ø1/2"	Bolsa 5	10

ESLINGA DE CARGA

Bandas planas 100% poliéster

Para levantar y mover cargas pesadas



Empaque original: 6 unidades

CODIGO	REF	MEDIDA / CARGA	UN.	PRECIO + IVA
17-35-240	17872	8 cm x 4 m / 3 t	Pza.	1
17-35-242	17873	8 cm x 6 m / 3 t	Pza.	1
17-35-244	17874	8 cm x 8 m / 3 t	Pza.	1

CUERDA CON GANCHOS PARA REMOLQUE

En estuche individual

- Carga de trabajo 1000 kg
- Tensión máxima 2000 kg
- Gran elasticidad para absorber los estiramientos
- Fabricada en polipropileno con ganchos de acero al carbono



Empaque original: 12 unidades

CODIGO	REF	MEDIDA/TIPO	UN.	PRECIO + IVA
17-35-130	18345	22 mm x 3,5 m	Pza.	1

SUJETADORES CON MATRACA

Juego 2 piezas

Para automóviles y motocicletas

675 kg

1.125 kg

1000 kg



CODIGO	REF	MEDIDA / CARGA	UN.	PRECIO + IVA
17-35-112	19281	3 m x 1" / 675 kg	Jgo.	3
17-35-110	19282	4 m x 1" / 1125 kg	Jgo.	3
17-35-109	19285	4,8 m x 1.1/4" / 1000 kg	Jgo.	2

Para trailers y camiones

3000 kg

5000 kg



CODIGO	REF	MEDIDA / CARGA	UN.	PRECIO + IVA
17-35-108	19286	9 m x 2" / 3000 kg	Jgo.	2
17-35-106	19287	9 m x 2" / 5000 kg	Jgo.	2

BANDOLA TIPO LLAVERO
Pecera con 30 piezas

Colores surtidos



PRETUL®

CODIGO	REF	MEDIDA / CARGA	UN.	PRECIO + IVA
17-35-160	65002	8 cm / carga ligera	Pza. 30	

TENSORES ELÁSTICOS
Set de 8 piezas

CONTENIDO:	
2 Pzas	45 cm
2 Pzas	60 cm
2 Pzas	90 cm
2 Pzas	122 cm



PRETUL®

CODIGO	REF	MEDIDA/TIPO	UN.	PRECIO + IVA
17-35-118	22021	-	Set 4	

Caja máster: 12 unidades

CADENA PLÁSTICA
Carrete de 8 mm x 25 m



Empaque original 8 carretes

CODIGO	REF	MEDIDA/TIPO	UN.	PRECIO + IVA
17-35-120	44181	Blanco	25 m 1	
17-35-122	44180	Negro	25 m 1	

PITILLA RAFIA BLANCA
Polipropileno 100% virgen

Calibre: 2.2g/m



CODIGO	REF	MEDIDA/TIPO	UN.	PRECIO + IVA
17-35-180	44492	410 m / 900 g	Rollo 6	

CUERDA DE POLIPROPILENO
Rollos de 20 kg

Desde 6 mm con filástica azul

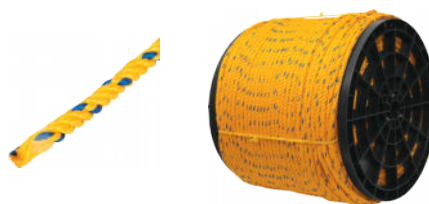

CODIGO	REF	MEDIDA/TIPO	UN.	PRECIO + IVA
17-35-190	44472	4 mm x 2600 m	Rollo 1	
17-35-192	44485	6 mm x 1100 m	Rollo 1	
17-35-194	44486	8 mm x 680 m	Rollo 1	
17-35-196	44487	10 mm x 480 m	Rollo 1	

FIERO®

CABLE DE ACERO RECUBIERTO DE PVC
Carrete de 75 metros

Recubrimiento que evita maltratos a productos que se fijan o aseguran con el cable

FIERO®



Aceros rígidos
7 x 7 hilos, recubierto

CODIGO	REF	MEDIDA/CARGA	UN.	PRECIO + IVA
17-35-171	44220	1/16" / 170 kg	Rollo 1	
17-35-176	44221	3/32" / 330 kg	Rollo 1	
17-35-170	44219	1/8" / 560 kg	Rollo 1	
17-35-172	44217	3/16" / 1.360 kg	Rollo 1	
17-35-174	44218	1/4" / 2.240 kg	Rollo 1	

CABLE DE ACERO
Carrete de 75 metros

FIERO®



Aceros rígidos
7 x 7 hilos

CODIGO	REF	MEDIDA/CARGA	UN.	PRECIO + IVA
17-35-212	44208	1/16" / 170 kg	Rollo 1	
17-35-214	44209	3/32" / 330 kg	Rollo 1	
17-35-210	44205	1/8" / 560 kg	Rollo 1	
17-35-216	44206	3/16" / 1.320 kg	Rollo 1	
17-35-218	44207	1/4" / 2.240 kg	Rollo 1	

MACHETE ESTÁNDAR
Mango plástico naranja



Caja máster: 24 unidades

CODIGO	REF	MEDIDA/TIPO	UN.	PRECIO + IVA
17-37-075	15885	18"	Pza. 4	
17-37-076	15886	20"	Pza. 4	
17-37-077	15887	22"	Pza. 4	

MACHETE DOBLE FILO
En display

Mango confort grip



CODIGO	REF	MEDIDA/TIPO	UN.	PRECIO + IVA
17-37-080	15893	18"	Pza. 6	

GUADAÑA TIPO AUSTRIACA
Forjada en una sola pieza de acero templado



Caja máster: 6 guadañas

CODIGO	REF	MEDIDA/TIPO	UN.	PRECIO + IVA
17-37-050	14900	26" x 4.1/4"	Pza. 1	

Mango con abrazadera



Empaque: atados 2 unidades.

17-37-054	15939	58"	Pza. 1	
-----------	-------	-----	--------	--

HACHA CAZADORA
Mango madera hickory americano

Cabeza forjada en acero al carbono con doble tratamiento térmico



CODIGO	REF	MEDIDA/TIPO	UN.	PRECIO + IVA
17-37-058	14950	14" - 1.1/4 lb	Pza. 4	

HACHA MEDIA LABOR
Mango fibra de vidrio

Cabeza forjada en acero 1045 con doble tratamiento térmico



CODIGO	REF	MEDIDA/TIPO	UN.	PRECIO + IVA
17-37-062	14972	36" - 4 lb	Pza. 2	
17-37-064	14974	36" - 4.1/2 lb	Pza. 2	

HACHA TAJADERA
Mango fibra de vidrio

- Cabeza de acero al carbono con doble tratamiento térmico para mayor resistencia y durabilidad de filo
- Grip antiderrapante con doble inyección que reduce vibraciones
- Ojo elíptico



CODIGO	REF	MEDIDA/TIPO	UN.	PRECIO + IVA
17-37-028	102085	4.1/2 lb	Pza. 2	

HACHA TAJADERA
Mango de nylon

Mango prácticamente indestructible, fabricado en resina de nylon



CODIGO	REF	MEDIDA/TIPO	UN.	PRECIO + IVA
17-37-027	100176	36" - 4 lb	Pza. 2	

MANGO PARA HACHA
Para hachas de 4 y 4.1/2 lb

Madera de encino



CODIGO	REF	MEDIDA/TIPO	UN.	PRECIO + IVA
17-37-066	15953	36"	Pza. 6	

HOZ DENTADA
Para corte de hierba y maleza



CODIGO	REF	MEDIDA/TIPO	UN.	PRECIO + IVA
17-37-056	15122	20" - 18 dpp	Pza. 1	

AZADÓN FORJADO

Sin mango



CODIGO	REF	MEDIDA/TIPO	UN.		PRECIO + IVA
17-37-004	10600	6.1/2" x 1.6 lb	Pza.	6	
17-37-003	10603	7.1/2" x 1.8 lb	Pza.	6	
17-37-005	10606	8" x 2 lb	Pza.	6	

AZADÓN FORJADO

Con mango fibra de vidrio 54"

- Forjado de una sola pieza en acero alto carbono



CODIGO	REF	MEDIDA/TIPO	UN.		PRECIO + IVA
17-37-002	10612	6.1/2" x 1.6 lb	Pza.	4	
17-37-001	10618	8" x 2 lb	Pza.	4	

DESHIERBADOR

Mango de fresno americano 54"

Cuchillas de doble filo



CODIGO	REF	MEDIDA/TIPO	UN.		PRECIO + IVA
17-37-022	15127	-	Pza.	3	

RASPADOR

Mango madera fresno

Mango de fresno americano



Mango largo

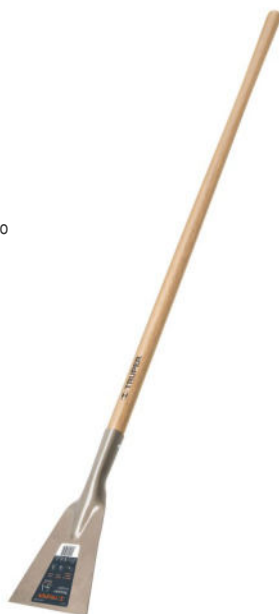

CODIGO	REF	MEDIDA/TIPO	UN.		PRECIO + IVA
17-37-018	18652	54" x 7"	Pza.	3	

CAVADOR ATLAS

Mango madera 48"

Acero templado



CODIGO	REF	MEDIDA/TIPO	UN.		PRECIO + IVA
17-37-020	11973	Apertura máx 6"	Pza.	2	

HORQUETA PARA PAJA

Mango madera

dientes	Cabeza
4	8.1/2" x 13"
5	9" x 13"
6	13" x 13"



Mango largo



CODIGO	REF	MEDIDA/TIPO	UN.		PRECIO + IVA
17-37-010	11003	48" - 4 dts	Pza.	3	
17-37-011	11006	48" - 5 dts	Pza.	3	
17-37-012	11009	48" - 6 dts	Pza.	3	

HORQUETA JARDÍN

Mango madera 27.1/2"

Puño de polipropileno



CODIGO	REF	MEDIDA/TIPO	UN.		PRECIO + IVA
17-37-014	11018	6.1/2" - 4 dts	Pza.	3	

FUMIGADOR DE MOCHILA

Lanza de acero inoxidable

- Pipeta de fibra de vidrio
- Boquilla polipropileno

ESPECIFICACIONES
 Presión de trabajo: 60 PSI
 Diámetro manguera: 1/2"
 Largo manguera: 135 cm
 Largo lanza: 61 cm
 Peso: 3.2 kg



CODIGO	REF	MEDIDA/TIPO	UN.	PRECIO + IVA
17-37-037	14695	12 L	Pza. 1	

FUMIGADOR

Lanza y boquilla ajustable de latón

ESPECIFICACIONES
 Presión de trabajo: 38 PSI
 Diámetro manguera: 7/32"
 Largo manguera: 125 cm
 Largo lanza: 36 cm



CODIGO	REF	MEDIDA/TIPO	UN.	PRECIO + IVA
17-37-044	10835	3 L	Pza. 1	
17-37-042	10836	5 L	Pza. 1	
17-37-040	10837	7 L	Pza. 1	

CORTADOR DE RAMAS ALTAS

Sin mango

- Hojas acero SK5, templada
- Cuchilla de paso templada
- Capacidad ramas de 1.1/4"
- Dientes triple filo



CODIGO	REF	MEDIDA/TIPO	UN.	PRECIO + IVA
17-37-026	18401	14"	Pza. 3	

RECOLECTOR DE FRUTA

Sin mango



CODIGO	REF	MEDIDA/TIPO	UN.	PRECIO + IVA
17-37-030	14338	13" x 6"	Pza. 6	

MANGO TELESCÓPICO

Fibra de vidrio

Este artículo también lo puede encontrar en la sección de jardinería

- Par cortador de ramas altas, recolector de fruta y serrucho de podar mango grip
- Extensión de 1.91 a 3.62 m

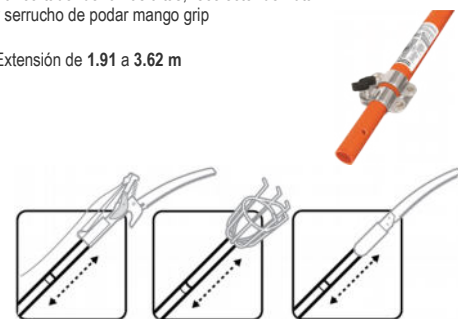

CODIGO	REF	MEDIDA/TIPO	UN.	PRECIO + IVA
17-37-025	16012	-	Pza. 3	

ASPERSOR AGRÍCOLA

Latón fundido

ESPECIFICACIONES:
Área de riego: 360°
Alcance máximo: 15 m



Caja máster: 3 piezas

CODIGO	REF	MEDIDA/TIPO	UN.	PRECIO + IVA
17-38-001	10317	1"	Pza. 1	

ASPERSOR METÁLICO

Conexiones de latón, estaca de 20 cm

- Funcionamiento óptimo con presión de 40 a 50 PSI
- Se puede conectar en serie

ESPECIFICACIONES:
Área de riego: 360°
Alcance máximo: 10,4 m



CODIGO	REF	MEDIDA/TIPO	UN.	PRECIO + IVA
17-38-006	10330	-	Pza. 6	

ASPERSOR PLÁSTICO REGULABLE

Con estaca de 21 cm

- Funcionamiento óptimo con presión de 40 a 50 PSI
- Se puede conectar en serie
- Clip de límite de riego

ESPECIFICACIONES:
Área de riego: 360° (regulable con clip)
Alcance máximo: 8,5 m



CODIGO	REF	MEDIDA/TIPO	UN.	PRECIO + IVA
17-38-005	10339	21 cm	Pza. 6	

ESTACA UNIVERSAL PARA ASPERSOR

Metálica



CODIGO	REF	MEDIDA/TIPO	UN.	PRECIO + IVA
17-38-060	10366	8"	Pza. 6	

ASPERSOR GIRATORIO

Brazos de aluminio

- Funcionamiento óptimo con presión de 40 a 50 PSI

ESPECIFICACIONES:
Área de riego: 360°
Alcance máximo: 6,3 m



Caja máster: 6 piezas

CODIGO	REF	MEDIDA/TIPO	UN.	PRECIO + IVA
17-38-008	10303	-	Pza. 1	

ASPERSOR OSCILATORIO

17 boquillas, metal-plástico

- Perilla de selección de patrones
- 17 boquillas de precisión
- Alcance a presión máxima: 8 m



Caja máster: 4 piezas

CODIGO	REF	MEDIDA/TIPO	UN.	PRECIO + IVA
17-38-010	10363	-	Pza. 1	

MANGUERA DE SUCCIÓN P/MOTOBOMBA

Para agua sucia y limpia

- Para la conducción de grandes flujos de agua limpia y sucia
- Fabricadas con PVC de alta resistencia a la intemperie
- Presión máxima de trabajo: 85 psi
- Fácil manejo, no incluye conexiones
- Flexible aún en climas extremos (frío / calor)

Conducción de grandes flujos

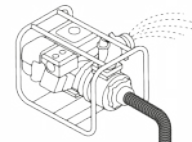

CODIGO	REF	MEDIDA/TIPO	UN.	PRECIO + IVA
17-38-200	100959	2" x 30 m	Pza. -	

LLAVE DE BOLA
Fabricada en Zinc

- Maneral de acero 1/4 de vuelta
- Conector metálico para manguera de 1/2"



CODIGO	REF	MEDIDA/TIPO	UN.	PZA.	PRECIO + IVA
17-38-070	23146	1/2" x 3/4"	Pza.	12	

PITÓN METÁLICO TIPO PISTOLA
8 funciones

- Cuerpo metálico recubierto
- Resorte de acero inoxidable
- Clip para flujo continuo

- FUNCIONES**
- ☉ Completo
 - ☉ Ángulo
 - ☉ Niebla
 - ☉ Plano
 - ☉ Jet
 - ☉ Centro
 - ☉ Regadera
 - ☉ Cono



CODIGO	REF	MEDIDA/TIPO	UN.	PZA.	PRECIO + IVA
17-38-014	18477	3/4 - 11.5 NH	Pza.	6	

MANGUERA JARDÍN CON PISTOLA
Tecnología anti-torceduras

- Manguera de 3 capas
- Espesor de 1.7 mm
- Conexiones plásticas

FUNCIONES

- ☉ Jet
- ☉ Cono



CODIGO	REF	MEDIDA/TIPO	UN.	PZA.	PRECIO + IVA
17-38-100	19750	1/2" - 15 m	Pza.	1	

CONECTOR DE RIEGO
Latón sólido



CODIGO	REF	MEDIDA/TIPO	UN.	PZA.	PRECIO + IVA
17-38-041	12286	3/4" Hembra	Pza.	6	
17-38-043	12287	3/4" Macho	Pza.	6	

CODIGO	REF	MEDIDA/TIPO	UN.	PZA.	PRECIO + IVA
17-38-040	12700	1/2" Hembra	Pza.	6	
17-38-042	12702	1/2" Macho	Pza.	6	

PITÓN METÁLICO TIPO PISTOLA
2 funciones

- Cuerpo metálico recubierto
- Boquilla regulable
- Resorte de acero inoxidable
- Clip para flujo continuo

FUNCIONES

- ☉ Jet
- ☉ Cono



CODIGO	REF	MEDIDA/TIPO	UN.	PZA.	PRECIO + IVA
17-38-016	18476	3/4 - 11.5 NH	Pza.	6	

PORTAMANGUERAS PLÁSTICO
Para mangueras hasta 25 metros

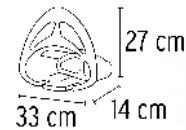

CODIGO	REF	MEDIDA/TIPO	UN.	PZA.	PRECIO + IVA
17-38-140	10638	-	Pza.	6	

SET DE CONECTORES
Sistema click

INCLUYE:
3 conectores machos y
1 conector hembra



Conexión
rápidas



CODIGO	REF	MEDIDA/TIPO	UN.	PZA.	PRECIO + IVA
17-38-050	12730	3/4"	Set	6	

PITÓN DE LATÓN



Sistema regulador
para rocío fino o
riego a chorro

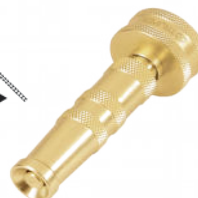
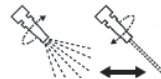

CODIGO	REF	MEDIDA/TIPO	UN.	PZA.	PRECIO + IVA
17-38-027	13130	HI 3/4" x 3"	Pza.	6	
17-38-029	13136	HI 3/4" x 4"	Pza.	6	

COLGADOR DE MANGUERAS
Para mangueras de 1/2" - 25 m

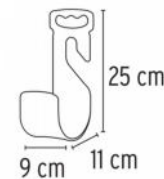

CODIGO	REF	MEDIDA/TIPO	UN.	PZA.	PRECIO + IVA
17-38-300	100173	9 x 25 cm	Pza.	6	

SELLADORES BAÑO Y COCINA

Formula anti hongos

- Para superficies lisas como : **cerámica, porcelana, vidrio, azulejo, formaica, aluminio, acero inoxidable, madera, etc.**
- Evita la formación de hongos
- Para uso **interior y exterior**
- Secado rápido

85 g



Caja máster: 36 un.

CODIGO	REF	MEDIDA/TIPO	UN.	PRECIO + IVA
17-39-001	18567	Transparente	Pza. 12	
17-39-003	18568	Blanco	Pza. 12	

280 g



Caja máster: 24 un.

CODIGO	REF	MEDIDA/TIPO	UN.	PRECIO + IVA
17-39-005	18565	Transparente	Pza. 6	
17-39-007	18566	Blanco	Pza. 6	

SELLADORES SILICONA

Uso general en interiores y exteriores

- Sellador 100% de silicon que proporciona un sellado duradero
- Para superficies lisas como: **vidrio, aluminio, cerámica, porcelana, madera, hierro**
- Buena adherencia en superficies lisas
- No cambia de color
- No se despeg a o reseca

85 g



Caja máster: 36 un.

CODIGO	REF	MEDIDA/TIPO	UN.	PRECIO + IVA
17-39-030	17562	Transparente	Pza. 12	

280 g



Caja máster: 24 un.

CODIGO	REF	MEDIDA/TIPO	UN.	PRECIO + IVA
17-39-032	17559	Transparente	Pza. 6	
17-39-034	17560	Blanco	Pza. 6	

SELLADORES ACRÍLICO

Pintable

- Sellador acrílico de fácil aplicación
- Una vez curado puede usar pintura (base agua, acrílica y vinílica)
- No usar en aplicaciones donde se encuentra sumergido en agua
- Para superficies lisas y porosas como: **tabique, fibrocemento, panel de yeso, ladrillo, madera, concreto y aluminio**

280 g



Caja máster: 24 un.

CODIGO	REF	MEDIDA/TIPO	UN.	PRECIO + IVA
17-39-010	18569	Transparente	Pza. 6	
17-39-012	18570	Blanco	Pza. 6	

SELLADOR POLIURETANO

Pintable

- Sella juntas entre materiales lisos y porosos, aún con **movimiento severo**
- Una vez curado puede usar pintura (base agua, acrílica y vinílica)
- Resistente a la humedad
- No mancha la piedra natural
- Para superficies lisas y porosas como **estructuras metálicas, muros y techos de concreto**

280 g



Caja máster: 24 un.

CODIGO	REF	MEDIDA/TIPO	UN.	PRECIO + IVA
17-39-020	12905	Gris	Pza. 6	

SILICONA ALTA TEMPERATURA Resistente hasta 250°

- Vulcanizan a temperatura ambiental
- Resisten temperaturas de -50° C a 250° C
- Se mantienen flexibles aun después de su aplicación
- No flamable
- No presentan grietas después del secado

85 g



Caja máster: 36 un.

CODIGO	REF	MEDIDA/TIPO	UN.	PRECIO + IVA
17-39-014	17566	Rojo	Pza. 6	
17-39-016	17567	Negro	Pza. 6	

BARRAS DE SILICONA Para pistola eléctrica

Blister con 12 barras



CODIGO	REF	MEDIDA/TIPO	UN.	PRECIO + IVA
17-39-044	17537	5/16" x 4"	Doc. 6	
17-39-040	17538	1/2" x 4"	Doc. 6	

Bolsa 1 Kg



CODIGO	REF	MEDIDA/TIPO	UN.	PRECIO + IVA
17-39-046	100081	5/16" x 12"	1 Kg 2	
17-39-042	100080	1/2" x 12"	1 Kg 2	

PALA CORTA

Fabricada en polipropileno



- Ranuras limpia cerdas de escoba
- Borde engomado adherente al piso
- Mango adaptable para almacenamiento con escoba



CODIGO	REF	MEDIDA/TIPO	UN.	PRECIO + IVA
17-41-001	57023	31 x 27 x 8 cm	Pza. 12	

PALA CON MANGO

Mango metálico con colgador



- Ranuras limpia cerdas de escoba
- Borde engomado adherente al piso
- Mango metálico 82 cm



CODIGO	REF	MEDIDA/TIPO	UN.	PRECIO + IVA
17-41-005	57024	23 x 27 x 8 cm	Pza. 12	

CEPILLO

Cerdas de PVC



Base de sujeción antideslizante



CODIGO	REF	MEDIDA/TIPO	UN.	PRECIO + IVA
17-41-021	57006	12 x 5 x 4 cm	Pza. 12	
17-41-020	57007	16 x 5 x 4 cm	Pza. 12	

CEPILLO GRANDE

Cerdas de PVC



Mango madera 120 cm



CODIGO	REF	MEDIDA/TIPO	UN.	PRECIO + IVA
17-41-022	57034	30 x 6 x 5 cm	Pza. 6	
17-41-015	57035	40 x 6 x 5 cm	Pza. 6	

ESCOBA MEDIANA

Cerdas de PVC



Mango madera 120 cm



CODIGO	REF	MEDIDA/TIPO	UN.	PRECIO + IVA
17-41-016	57053	26 x 14 cm	Pza. 12	
17-41-010	57054	26 x 17 cm	Pza. 12	
17-41-018	57055	30 x 17 cm	Pza. 12	

ESCOBA GRANDE

Cerdas de PVC



Mango madera 120 cm



CODIGO	REF	MEDIDA/TIPO	UN.	PRECIO + IVA
17-41-008	57051	23 x 21 cm	Pza. 12	
17-41-014	57052	24 x 27 cm	Pza. 12	

BARRE AGUAS

Cuerpo de polipropileno y hule suave



Mango madera 120 cm



CODIGO	REF	MEDIDA/TIPO	UN.	PRECIO + IVA
17-41-038	57017	40 x 5 cm	Pza. 12	

BARRE AGUAS

Cuerpo metálico y hule suave



Mango madera 120 cm



CODIGO	REF	MEDIDA/TIPO	UN.	PRECIO + IVA
17-41-039	57016	50 x 4 cm	Pza. 12	

TRAPEADOR MICROFIBRA

55% poliéster 45% rayón



- Tiras de rayón y poliéster
- Capuchón de polipropileno para cambio de bastón
- Mango madera 120 cm



No suelta pelusa

CODIGO	REF	MEDIDA/TIPO	UN.	PRECIO + IVA
17-41-036	57075	43 x 15 cm / 185g	Pza. 6	

TRAPEADOR

Pabilos 100% algodón



- Gran absorción y retención de líquidos
- Mango madera 120 cm



CODIGO	REF	MEDIDA/TIPO	UN.	PRECIO + IVA
17-41-029	57060	38 x 22 cm / 225g	Pza. 6	
17-41-030	57056	40 x 22 cm / 324g	Pza. 6	
17-41-028	57061	42 x 22 cm / 410g	Pza. 6	

BALDE EXPRIMIDOR



Exprima el trapeador fácilmente sin mojarse las manos



CODIGO	REF	MEDIDA/TIPO	UN.	PRECIO + IVA
17-41-032	55961	8 L	Pza. 4	

TOALLA MICROFIBRA

80% poliéster, 20% poliamida



- No raya las superficies
- Libre de pelusa
- No absorbe olores



CODIGO	REF	MEDIDA/TIPO	UN.	PRECIO + IVA
17-41-040	57065	40 x 40 cm	Pza. 6	

CREMA DESENGRASANTE

Para manos



- Eficaz para limpiar grasa, suciedad, tinta, pegamento, aceites y pintura de las manos



Caja máster: 2 unidades

CODIGO	REF	MEDIDA/TIPO	UN.	PRECIO + IVA
17-41-050	56032	1 gal (3.8 L)	Pza. 1	

ACEITE ROJO PARA MUEBLES



Para muebles, pisos de madera laminados y vinil



CODIGO	REF	MEDIDA/TIPO	UN.	PRECIO + IVA
17-41-060	57070	240 ml	Pza. 6	

BROCAS HSS RECTIFICADA – SPLIT POINT DIN 338

Material N° 1.3343 = DM 05 Rectificada Total

Tolerancia de diámetro h8, punta especial "Split Point" a partir de 2,5 mm

Perfora directo sin necesidad de marcar un punto en el material

Perfora seguro en superficies no planas, tuberías y soldaduras

La fuerza de empuje se reduce en un 50%

Perfora más rápido: hasta un 45 %

Alta seguridad contra quebrazón y larga vida útil

Rotación 100% exacta - orificios 100% circulares

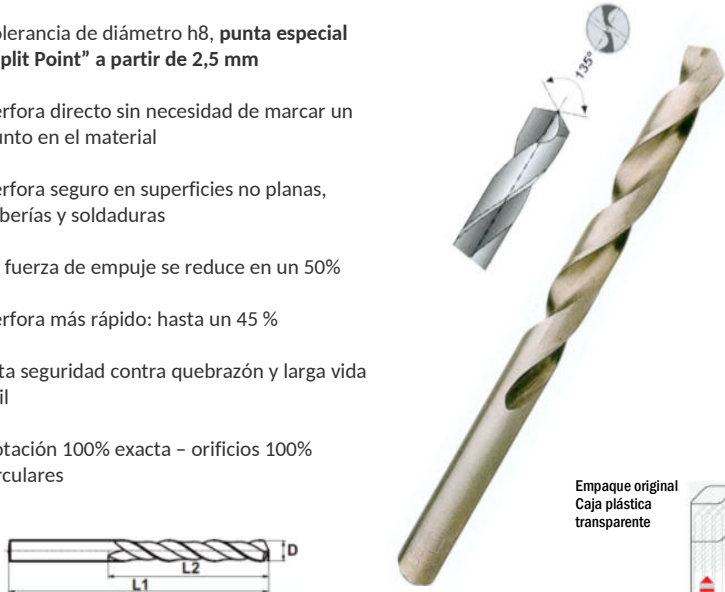

Empaque original
Caja plástica
transparente



CODIGO	DIAMETRO	L1 - L2	UN.		PRECIO + IVA
51-01-410	1,0 mm	34 - 12 mm	Pza.	10	
51-01-412	1,5 mm	40 - 18 mm	Pza.	10	
51-01-414	2,0 mm	49 - 24 mm	Pza.	10	
51-01-416	2,5 mm	57 - 30 mm	Pza.	10	
51-01-418	3,0 mm	61 - 33 mm	Pza.	10	
51-01-425	3,5 mm	70 - 39 mm	Pza.	10	
51-01-428	4,0 mm	75 - 43 mm	Pza.	10	
51-01-432	4,5 mm	80 - 47 mm	Pza.	10	
51-01-436	5,0 mm	86 - 52 mm	Pza.	10	
51-01-440	5,5 mm	93 - 57 mm	Pza.	10	
51-01-442	6,0 mm	93 - 57 mm	Pza.	10	
51-01-444	6,5 mm	101 - 63 mm	Pza.	10	
51-01-448	7,0 mm	109 - 69 mm	Pza.	10	
51-01-450	7,5 mm	109 - 69 mm	Pza.	10	
51-01-452	8,0 mm	117 - 75 mm	Pza.	10	
51-01-454	8,5 mm	117 - 75 mm	Pza.	10	
51-01-456	9,0 mm	125 - 81 mm	Pza.	10	
51-01-458	9,5 mm	125 - 81 mm	Pza.	10	
51-01-460	10,0 mm	133 - 87 mm	Pza.	10	
51-01-461	10,5 mm	133 - 87 mm	Pza.	5	
51-01-462	11,0 mm	142 - 94 mm	Pza.	5	
51-01-463	11,5 mm	142 - 94 mm	Pza.	5	
51-01-464	12,0 mm	151 - 101 mm	Pza.	5	
51-01-465	12,5 mm	151 - 101 mm	Pza.	5	
51-01-466	13,0 mm	151 - 101 mm	Pza.	5	

Vástago rebajado a 13 mm

51-01-468	14,0 mm	160 - 108 mm	Pza.	5	
51-01-470	15,0 mm	169 - 114 mm	Pza.	5	
51-01-472	16,0 mm	178 - 120 mm	Pza.	5	

BROCAS COBALTO

HSS-E Rectificada – Split Point DIN 338

Aleación con Cobalto 5%, según normas internacionales.

Material N° 1.3243 = Emo5Co5

Para aceros de alta dureza sobre 800 N/mm², aleaciones especiales, acero inoxidable V2A-V4A

Tolerancia de diámetro h8, punta especial "Split Point" a partir de 2,5 mm

Perfora directo sin necesidad de marcar un punto en el material

Perfora seguro en superficies no planas, tuberías y soldaduras

La fuerza de empuje se reduce en un 50%

Perfora más rápido: hasta un 45 %

Alta seguridad contra quebrazón y larga vida útil

Rotación 100% exacta - orificios 100% circulares

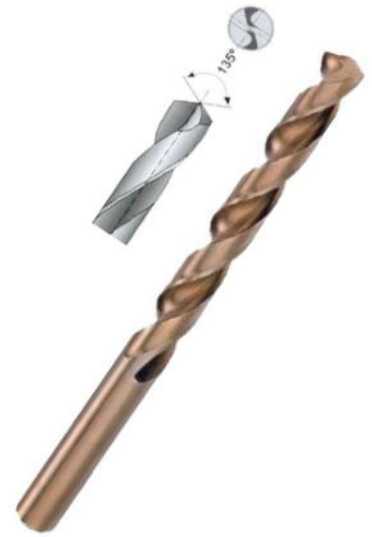

Empaque original
Caja plástica
transparente



CODIGO	DIAMETRO	L1 - L2	UN.		PRECIO + IVA
51-01-480	1,0 mm	34 - 12 mm	Pza.	10	
51-01-482	2,0 mm	40 - 24 mm	Pza.	10	
51-01-484	2,5 mm	57 - 30 mm	Pza.	10	
51-01-486	3,0 mm	61 - 33 mm	Pza.	10	
51-01-488	3,5 mm	70 - 39 mm	Pza.	10	
51-01-490	4,0 mm	75 - 43 mm	Pza.	10	
51-01-492	4,5 mm	80 - 47 mm	Pza.	10	
51-01-494	5,0 mm	86 - 52 mm	Pza.	10	
51-01-496	5,5 mm	93 - 57 mm	Pza.	10	
51-01-498	6,0 mm	93 - 57 mm	Pza.	10	
51-01-500	6,5 mm	101 - 63 mm	Pza.	10	
51-01-502	7,0 mm	109 - 69 mm	Pza.	10	
51-01-503	7,5 mm	109 - 69 mm	Pza.	10	
51-01-504	8,0 mm	117 - 75 mm	Pza.	10	
51-01-506	8,5 mm	117 - 75 mm	Pza.	10	
51-01-507	9,0 mm	125 - 81 mm	Pza.	10	
51-01-508	9,5 mm	125 - 81 mm	Pza.	10	
51-01-510	10,0 mm	133 - 87 mm	Pza.	10	

BROCAS HSS

Fabricadas en Alemania, según normas internacionales, DIN 338

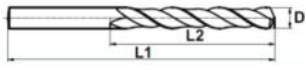

CODIGO	DIAMETRO	L1 - L2	UN.		PRECIO + IVA
51-01-105	1,0 mm	34 - 12 mm	Pza.	10	
51-01-110	1,5 mm	40 - 18 mm	Pza.	10	
51-01-115	2,0 mm	49 - 24 mm	Pza.	10	
51-01-120	2,5 mm	57 - 30 mm	Pza.	10	
51-01-125	3,0 mm	61 - 33 mm	Pza.	10	
51-01-128	3,2 mm	65 - 36 mm	Pza.	10	
51-01-131	3,5 mm	70 - 39 mm	Pza.	10	
51-01-136	4,0 mm	75 - 43 mm	Pza.	10	
51-01-139	4,2 mm	75 - 43 mm	Pza.	10	
51-01-142	4,5 mm	80 - 47 mm	Pza.	10	
51-01-147	5,0 mm	86 - 52 mm	Pza.	10	
51-01-150	5,2 mm	86 - 52 mm	Pza.	10	
51-01-153	5,5 mm	93 - 57 mm	Pza.	10	
51-01-158	6,0 mm	93 - 57 mm	Pza.	10	
51-01-163	6,5 mm	101 - 63 mm	Pza.	10	
51-01-168	7,0 mm	109 - 69 mm	Pza.	10	
51-01-173	7,5 mm	109 - 69 mm	Pza.	10	
51-01-178	8,0 mm	117 - 75 mm	Pza.	10	
51-01-183	8,5 mm	117 - 75 mm	Pza.	10	
51-01-188	9,0 mm	125 - 81 mm	Pza.	10	
51-01-193	9,5 mm	125 - 81 mm	Pza.	10	
51-01-198	10,0 mm	133 - 87 mm	Pza.	10	
51-01-203	10,5 mm	133 - 87 mm	Pza.	5	
51-01-208	11,0 mm	142 - 94 mm	Pza.	5	
51-01-213	11,5 mm	142 - 94 mm	Pza.	5	
51-01-218	12,0 mm	151 - 101 mm	Pza.	5	
51-01-223	12,5 mm	151 - 101 mm	Pza.	5	
51-01-228	13,0 mm	151 - 101 mm	Pza.	5	

Vástago rebajado a 13 mm

51-01-238	14,0 mm	160 - 108 mm	Pza.	5	
51-01-248	15,0 mm	169 - 114 mm	Pza.	5	
51-01-258	16,0 mm	178 - 120 mm	Pza.	5	
51-01-268	17,0 mm	184 - 125 mm	Pza.	5	
51-01-278	18,0 mm	191 - 130 mm	Pza.	5	
51-01-282	19,0 mm	198 - 135 mm	Pza.	5	
51-01-286	20,0 mm	205 - 140 mm	Pza.	5	

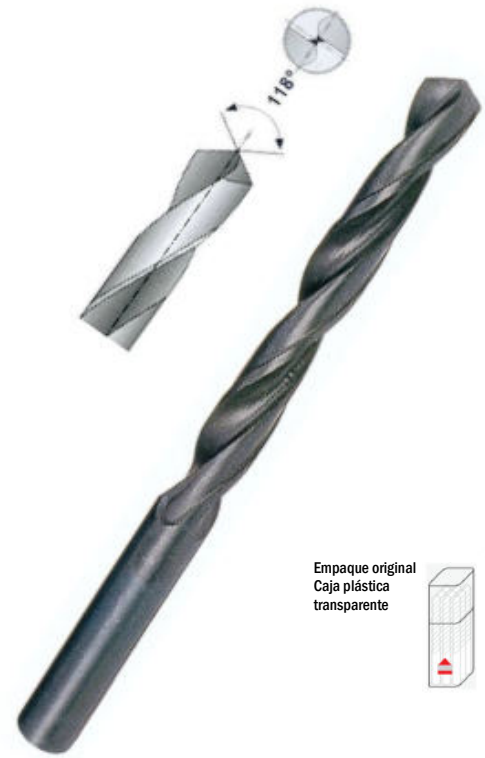

Empaque original
Caja plástica
transparente



BROCA HSS

vástago sin rebaje

CODIGO	DIAMETRO	L1 - L2	UN.		PRECIO + IVA
51-01-259	16,0 mm	-	Pza.	5	

BROCAS HSS

En pulgadas

CODIGO	DIAMETRO	L1 - L2	UN.		PRECIO + IVA
51-01-020	1/8"	-	Pza.	10	
51-01-026	5/32"	-	Pza.	10	
51-01-029	3/16"	-	Pza.	10	
51-01-032	1/4"	-	Pza.	10	
51-01-035	5/16"	-	Pza.	10	
51-01-038	3/8"	-	Pza.	5	
51-01-044	1/2"	-	Pza.	5	

BROCAS PARA VIDRIO Y CERÁMICA

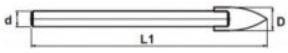

En estuche plástico individual



CODIGO	DIAMETRO	L1 - L2	UN.		PRECIO + IVA
51-03-280	3,0 mm	58 - 3,0 mm	Pza.	5	
51-03-281	4,0 mm	58 - 3,5 mm	Pza.	5	
51-03-282	5,0 mm	58 - 4,0 mm	Pza.	5	
51-03-283	6,0 mm	58 - 5,0 mm	Pza.	5	
51-03-285	8,0 mm	78 - 6,0 mm	Pza.	5	
51-03-287	10,0 mm	98 - 6,0 mm	Pza.	5	

BROCAS HSS RECTIFICADA - PARA CARROCERÍA

Fabricadas en Alemania, según norma DIN 338

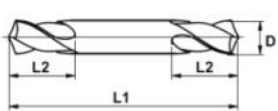

Empaque original
Caja plástica transparente



CODIGO	DIAMETRO	L1 - L2	UN.		PRECIO + IVA
51-01-005	3,2 mm	49 - 10 mm	Pza.	10	
51-01-008	4,2 mm	55 - 13 mm	Pza.	10	
51-01-012	5,2 mm	62 - 16 mm	Pza.	10	

BROCAS PARA MADERA

Fabricadas en Alemania, según normas internacionales, DIN 7487



En estuche plástico individual



CODIGO	DIAMETRO	L1 - L2	UN.		PRECIO + IVA
51-02-130	3,0 mm	61 - 33 mm	Pza.	5	
51-02-140	4,0 mm	75 - 43 mm	Pza.	5	
51-02-150	5,0 mm	86 - 52 mm	Pza.	5	
51-02-160	6,0 mm	93 - 57 mm	Pza.	5	
51-02-170	7,0 mm	109 - 69 mm	Pza.	5	
51-02-180	8,0 mm	117 - 75 mm	Pza.	5	
51-02-190	9,0 mm	120 - 81 mm	Pza.	5	
51-02-200	10,0 mm	120 - 81 mm	Pza.	5	

Vástago rebajado a 10 mm

51-02-210	11,0 mm	142 - 89 mm	Pza.	5	
51-02-220	12,0 mm	151 - 96 mm	Pza.	5	
51-02-230	13,0 mm	151 - 96 mm	Pza.	5	

BROCAS PARA PIEDRA

Fabricadas en Alemania, según norma DIN 8039/ISO 5468

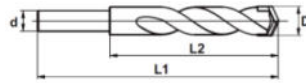

CODIGO	DIAMETRO	L1 - L2	UN.		PRECIO + IVA
51-03-110	4,0 mm	75 - 40 mm	Pza.	5	
51-03-115	5,0 mm	85 - 50 mm	Pza.	5	
51-03-120	6,0 mm	100 - 60 mm	Pza.	5	
51-03-122	6,5 mm	100 - 60 mm	Pza.	5	
51-03-125	7,0 mm	100 - 60 mm	Pza.	5	
51-03-130	8,0 mm	120 - 80 mm	Pza.	5	
51-03-135	10,0 mm	120 - 80 mm	Pza.	5	
51-03-140	12,0 mm	150 - 90 mm	Pza.	5	
51-03-145	13,0 mm	150 - 90 mm	Pza.	5	
51-03-146	14,0 mm	150 - 90 mm	Pza.	5	
51-03-148	16,0 mm	150 - 90 mm	Pza.	5	



En estuche
plástico
individual



BROCAS LARGAS PARA PIEDRA

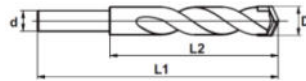

CODIGO	DIAMETRO	L1 - L2	UN.		PRECIO + IVA
51-03-200	6,0 mm	150 - 110 mm	Pza.	10	
51-03-205	8,0 mm	200 - 135 mm	Pza.	10	
51-03-210	10,0 mm	200 - 135 mm	Pza.	10	
51-03-215	12,0 mm	200 - 135 mm	Pza.	10	

BROCAS SÚPER LARGAS PARA PIEDRA

Calidad profesional, con vástago hexagonal



CODIGO	DIAMETRO	L1 - L2	UN.		PRECIO + IVA
51-03-220	8,0 mm	400 - 350 mm	Pza.	-	
51-03-225	10,0 mm	400 - 350 mm	Pza.	-	

BROCA PARA PIEDRA “TURBO HEAD XPRO”

Cabezal carburo / cuerpo acero Cromo Níquel Molibdeno

Poderoso cabezal de carburo con diseño innovador tipo “X” con punta que reduce vibraciones y aumenta velocidad de perforado

Cuerpo delimitado para facilitar la rápida eliminación de polvo

Para taladrar agujeros ciegos y hormigón armado



En estuche plástico individual



CODIGO	DIAMETRO	L1 - L2	UN.		PRECIO + IVA
51-03-251	6,0 mm	100 - 60 mm	Pza.	5	
51-03-252	8,0 mm	120 - 75 mm	Pza.	5	
51-03-253	10,0 mm	120 - 75 mm	Pza.	5	

BROCAS PARA PIEDRA “MS5 TURBOKEIL”

Acero Cromo Níquel Molibdeno, “endurecido y fresado”

Placa de Vidia de forma especial y calidad superior, con punta, que permite perforar más rápidamente, con menor esfuerzo y mayor precisión

Materiales y características garantizan una larga vida útil de la broca

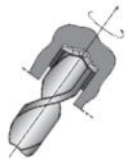

En estuche plástico individual



CODIGO	DIAMETRO	L1 - L2	UN.		PRECIO + IVA
51-03-231	5,0 mm	85 - 50 mm	Pza.	5	
51-03-233	6,0 mm	100 - 60 mm	Pza.	5	
51-03-236	8,0 mm	120 - 75 mm	Pza.	5	
51-03-239	10,0 mm	120 - 75 mm	Pza.	5	
51-03-240	12,0 mm	150 - 100 mm	Pza.	5	

Vástago rebajado a 13 mm

51-03-241	14,0	150 - 100 mm	Pza.	5	
-----------	------	--------------	------	---	--

BROCAS SDS-PLUS PARA CONCRETO

Acero Cromo Níquel Molibdeno

Elaboradas en Alemania, según licencia Bosch, para todo tipo de taladros martillo con mandril SDS-PLUS o Hilti



En estuche plástico individual

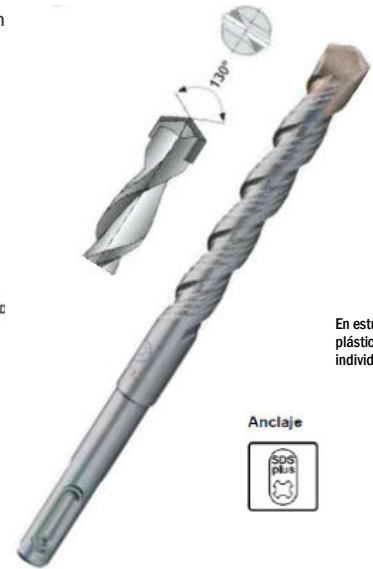

CODIGO	DIAMETRO	L1 - L2	UN.		PRECIO + IVA
51-03-315	6,0 mm	160 - 100 mm	Pza.	5	
51-03-316	6,0 mm	210 - 150 mm	Pza.	5	
51-03-317	6,0 mm	260 - 200 mm	Pza.	5	
51-03-325	8,0 mm	160 - 100 mm	Pza.	5	
51-03-330	8,0 mm	210 - 150 mm	Pza.	5	
51-03-331	8,0 mm	260 - 200 mm	Pza.	5	
51-03-345	10,0 mm	260 - 200 mm	Pza.	5	
51-03-347	10,0 mm	360 - 300 mm	Pza.	5	
51-03-353	12,0 mm	160 - 100 mm	Pza.	5	
51-03-355	12,0 mm	260 - 200 mm	Pza.	5	
51-03-358	12,0 mm	450 - 400 mm	Pza.	5	

BROCAS PARA GRANITO "PRIMUS"

Se adapta a toda perforación rotatoria y de percusión

Similar calidad a la broca "TurboKeil", pero gracias a su geometría distinta de traslado de viruta permite adicionalmente perforar madera, plástico, y acrílico



En estuche plástico individual

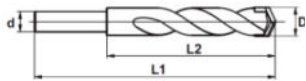

CODIGO	DIAMETRO	L1 - L2	UN.	PRECIO + IVA
51-03-430	4,0 mm	75 - 40 mm	Pza. 5	

BROCAS PARA CERÁMICA DURA

Punta de carburo de Tungsteno-Titanio TSM

Forma espiral asimétrica, canal fresado para un óptimo desalojo de residuos
Con mango ROTASTOP

Recomendado: * 600 a 1200 rpm (enfriamiento con agua, prolonga vida útil)
IMPORTANTE: * sólo ROTACION, no usar en "percusión"



En estuche plástico individual

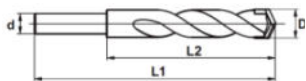

CODIGO	DIAMETRO	L1 - L2	UN.	PRECIO + IVA
51-03-242	4,0 mm	75 - 40 mm	Pza. 5	
51-03-246	6,0 mm	100 - 60 mm	Pza. 5	
51-03-248	8,0 mm	120 - 80 mm	Pza. 5	

BROCA PARA PORCELANATO

Cabeza de diamantes electrodepositados

CARACTERÍSTICAS

Diamantes electrodepositados

Superficie bruñida

Interior relleno con líquido refrigerante

APLICACIÓN

Para baldosas de gres, azulejos, vidrio, mármol, granito y piedra

En todos los equipos de perforación rotatoria

RECOMENDACIONES

Tiempo recomendado de enfriamiento 10 segundos

Se puede utilizar sin agua

Al añadir agua se prolonga su vida útil

Recomendado: *1600 a 2000 rpm

IMPORTANTE: *sólo ROTACION, no usar en "percusión"

En estuche plástico individual



CODIGO	DIAMETRO	L1 - L2 - SW	UN.	PRECIO + IVA
51-03-256	6.0 mm	67- 32 - 9,0 mm	Pza. -	
51-03-258	8.0 mm	80- 40 - 9,0 mm	Pza. -	
51-03-260	10.0 mm	80 - 40 - 9,0 mm	Pza. -	

JUEGO DE BROCAS HSS
En Caja Plástica



CODIGO	DIAMETRO	L1 - L2	UN.		PRECIO + IVA
51-01-350	4, 5, 6, 8, 10 mm	-	Jgo.	10	

JUEGO DE BROCAS HSS RECTIFICADA – SPLIT POINT
25 Piezas en Caja Plástica



CODIGO	DIAMETRO	L1 - L2	UN.		PRECIO + IVA
51-01-476	De 1,0 a 13 mm	-	Jgo.	10	

JUEGO DE BROCAS HSS-RECTIFICADA
5 Piezas

Para conexión directa a atornillador/taladro para puntas de 1/4" (Brocas aptas para taladrar metal, madera y PVC)

NOTA: Los atornilladores recargables modernos sirven perfectamente para taladrar. Por este motivo Keil desarrolló estas brocas que permiten trabajar más rápido sin cambio de máquina



CODIGO	DIAMETRO	L1 - L2	UN.		PRECIO + IVA
51-01-405	3, 4, 5, 6, 8 mm	-	Jgo.	10	

JUEGO DE BROCAS HSS
En caja metálica



CODIGO	DIAMETRO	L1 - L2	UN.		PRECIO + IVA
19 piezas (de 1.0 a 10 mm)					
51-01-355	-	-	Jgo.	-	

CODIGO	DIAMETRO	L1 - L2	UN.		PRECIO + IVA
25 Piezas (de 1.0 a 13 mm)					
51-01-360	-	-	Jgo.	-	

BROCAS HSS



CODIGO	DIAMETRO	UN.		MIN,	PRECIO + IVA
01-01-394	0.6 mm	Pza.	10	-	
01-01-398	0.8 mm	Pza.	10	-	
01-01-400	0.9 mm	Pza.	10	-	
01-01-401	1,0 mm	Pza.	10	-	
01-01-405	1,5 mm	Pza.	10	-	
01-01-410	2,0 mm	Pza.	10	-	
01-01-415	2,5 mm	Pza.	10	-	
01-01-423	3,0 mm	Pza.	10	-	
01-01-431	3,5 mm	Pza.	10	-	
01-01-436	4,0 mm	Pza.	10	-	
01-01-438	4,2 mm	Pza.	10	-	
01-01-444	4,5 mm	Pza.	10	-	
01-01-449	5,0 mm	Pza.	10	-	
01-01-453	5,2 mm	Pza.	10	-	
01-01-457	5,5 mm	Pza.	10	-	
01-01-462	6,0 mm	Pza.	10	-	
01-01-467	6,5 mm	Pza.	10	-	
01-01-472	7,0 mm	Pza.	5	-	
01-01-477	7,5 mm	Pza.	5	-	
01-01-482	8,0 mm	Pza.	5	-	
01-01-487	8,5 mm	Pza.	5	-	
01-01-492	9,0 mm	Pza.	5	-	
01-01-497	9,5 mm	Pza.	5	-	
01-01-502	10,0 mm	Pza.	5	-	
01-01-507	10,5 mm	Pza.	5	-	
01-01-512	11,0 mm	Pza.	5	-	
01-01-522	12,0 mm	Pza.	5	-	
01-01-532	13,0 mm	Pza.	5	-	
01-01-542	14,0 mm	Pza.	5	-	
01-01-552	15,0 mm	Pza.	5	-	
01-01-562	16,0 mm	Pza.	5	-	
01-01-572	17,0 mm	Pza.	5	-	
01-01-582	18,0 mm	Pza.	5	-	
01-01-592	19,0 mm	Pza.	5	-	
01-01-594	20,0 mm	Pza.	5	-	

BROCAS HSS/TITANIUM

Excelente calidad y presentación

Brocas HSS con cubierta de "Titanio", que multiplica el tiempo de duración del filo y la vida útil



CODIGO	DIAMETRO	UN.		MIN,	PRECIO + IVA
01-01-105	1.0 mm	Pza.	10	-	
01-01-111	1.5 mm	Pza.	10	-	
01-01-117	2.0 mm	Pza.	10	-	
01-01-123	2.5 mm	Pza.	10	-	
01-01-129	3.0 mm	Pza.	10	-	
01-01-136	3.5 mm	Pza.	10	-	
01-01-142	4.0 mm	Pza.	10	-	
01-01-149	4.5 mm	Pza.	10	-	
01-01-155	5.0 mm	Pza.	10	-	
01-01-162	5.5 mm	Pza.	10	-	
01-01-168	6.0 mm	Pza.	10	-	
01-01-174	6.5 mm	Pza.	10	-	
01-01-180	7.0 mm	Pza.	5	-	
01-01-186	7.5 mm	Pza.	5	-	
01-01-192	8.0 mm	Pza.	5	-	
01-01-198	8.5 mm	Pza.	5	-	
01-01-204	9.0 mm	Pza.	5	-	
01-01-210	9.5 mm	Pza.	5	-	
01-01-216	10.0 mm	Pza.	5	-	
01-01-220	10.5 mm	Pza.	5	-	
01-01-225	11.0 mm	Pza.	5	-	
01-01-230	11.5 mm	Pza.	5	-	
01-01-235	12.0 mm	Pza.	5	-	
01-01-240	12.5 mm	Pza.	5	-	
01-01-245	13.0 mm	Pza.	5	-	

En pulgadas

01-01-275	3/32"	Pza.	10	-	
01-01-280	1/8"	Pza.	10	-	
01-01-285	5/32"	Pza.	10	-	
01-01-290	3/16"	Pza.	10	-	
01-01-295	1/4"	Pza.	10	-	
01-01-300	5/16"	Pza.	5	-	
01-01-305	3/8"	Pza.	5	-	

BROCAS PARA MADERA

En estuche plástico individual



CODIGO	DIAMETRO / LARGO	UN.		MIN,	PRECIO + IVA
01-02-200	3 x 60 mm	Pza.	5	-	
01-02-202	4 x 75 mm	Pza.	5	-	
01-02-204	5 x 85 mm	Pza.	5	-	
01-02-206	6 x 100 mm	Pza.	5	-	
01-02-208	7 x 100 mm	Pza.	5	-	
01-02-210	8 x 120 mm	Pza.	5	-	
01-02-212	9 x 120 mm	Pza.	5	-	
01-02-214	10 x 120 mm	Pza.	5	-	
01-02-216	11 x 150 mm	Pza.	5	-	
01-02-218	12 x 150 mm	Pza.	5	-	
01-02-220	13 x 150 mm	Pza.	5	-	

BROCAS SDS-PLUS "ULM" PARA CONCRETO

En estuche plástico individual

Fabricadas según licencia Bosch, para todo tipo de taladros martillo con mandril SDS-PLUS o Hilti



CODIGO	DIAMETRO / LARGO	UN.		MIN,	PRECIO + IVA
01-03-105	6 x 150 mm	Pza.	5	-	
01-03-110	8 x 150 mm	Pza.	5	-	
01-03-115	10 x 200 mm	Pza.	3	-	
01-03-125	12 x 200 mm	Pza.	3	-	
01-03-130	13 x 200 mm	Pza.	3	-	
01-03-135	14 x 200 mm	Pza.	2	-	
01-03-140	16 x 300 mm	Pza.	2	-	
01-03-145	18 x 300 mm	Pza.	2	-	

BROCAS PARA PIEDRA

En estuche plástico individual



CODIGO	DIAMETRO	UN.		MIN,	PRECIO + IVA
01-02-100	3 mm	Pza.	5	-	
01-02-102	4 mm	Pza.	5	-	
01-02-104	5 mm	Pza.	5	-	
01-02-106	6 mm	Pza.	5	-	
01-02-110	8 mm	Pza.	5	-	
01-02-114	10 mm	Pza.	5	-	
01-02-118	12 mm	Pza.	5	-	

BROCAS HSS - CONO MORSE DIN 345

En caja individual litografiada

- Acero rápido de alto rendimiento.
- Corte Derecho, tipo N.
- 118° Sección Cónica.
- Tolerancia Diámetro h8.
- Espiral rectificada.
- Para uso en Metal/Acero solamente rotatorio.

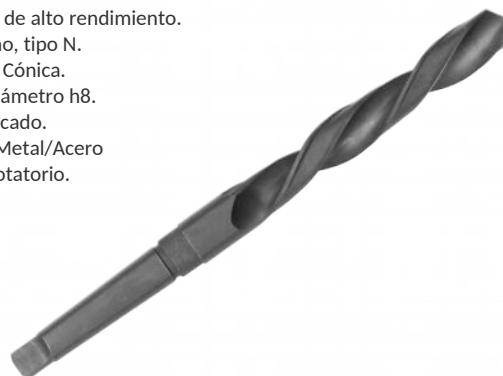

CODIGO	DIAMETRO	UN.		MIN,	PRECIO + IVA
01-01-610	18 mm	Pza.	-	-	
01-01-613	19 mm	Pza.	-	-	
01-01-616	20 mm	Pza.	-	-	
01-01-619	21 mm	Pza.	-	-	
01-01-622	22 mm	Pza.	-	-	
01-01-625	23 mm	Pza.	-	-	
01-01-628	24 mm	Pza.	-	-	
01-01-631	25 mm	Pza.	-	-	
01-01-634	26 mm	Pza.	-	-	
01-01-637	27 mm	Pza.	-	-	
01-01-640	28 mm	Pza.	-	-	
01-01-643	30 mm	Pza.	-	-	
01-01-646	31 mm	Pza.	-	-	
01-01-649	32 mm	Pza.	-	-	

DISCO DE CORTE METAL PLANO

Para corte de metales y materiales ferrosos

Fabricación en óxido de aluminio y aglomerante de resina sintética reforzado con malla fibrosa



CODIGO	REF.	MEDIDA/TIPO	UN.	MIN.	PRECIO + IVA
35-03-020	-	4.1/2" x 3 mm	Pza.	10	
35-03-032	-	7" x 3 mm	Pza.	10	
35-03-038	-	9" x 3 mm	Pza.	10	
35-03-040	-	14" x 2.4 mm	Pza.	10	

DISCO DE CORTE PIEDRA PLANO

Para corte de baldosas y pétreos

Fabricación en carburo de silicio y aglomerante de resina sintética reforzado con malla fibrosa



CODIGO	REF.	MEDIDA/TIPO	UN.	MIN.	PRECIO + IVA
35-03-072	-	4.1/2" x 3 mm	Pza.	10	
35-03-081	-	7" x 3 mm	Pza.	10	

DISCO DE CORTE METAL PLANO INOXIDABLE

Para corte de acero inoxidable

Fabricación en corindón y aglomerante de resina sintética reforzado con malla fibrosa



CODIGO	REF.	MEDIDA/TIPO	UN.	MIN.	PRECIO + IVA
35-03-044	-	4.1/2" x 1 mm	Pza.	10	
35-03-046	-	7" x 1.6 mm	Pza.	10	

DISCO DE DESBASTE METAL ABOVEDADO

Para desbaste de metal

Fabricación en óxido de aluminio y aglomerante de resina sintética reforzado con malla fibrosa



CODIGO	REF.	MEDIDA/TIPO	UN.	MIN.	PRECIO + IVA
35-03-108	-	4.1/2" x 6 mm	Pza.	10	
35-03-114	-	7" x 6 mm	Pza.	10	

PERFECT

Discos perfectos para artesanos y profesionales. Buena duración y tronzado rápido a precios ventajosos.

Discos de corte para metal

A-60 R "PLANO"

1mm
GROSOR



CODIGO	MEDIDAS	UN.	PRECIO + IVA
42-03-010	4,1/2" 115 x 1 x 22,2 mm	Pza. 25	

A-30 T "ABOVEDADO"

Disco de desbaste para metal



CODIGO	MEDIDAS	UN.	PRECIO + IVA
42-03-108	4,1/2" 115 x 6 x 22,2 mm	Pza. 25	
42-03-114	7" 180 x 6 x 22,2 mm	Pza. 25	

Discos de corte para concreto

A-24 R



CODIGO	MEDIDAS	UN.	PRECIO + IVA
42-03-020	4,1/2" 115 x 3 x 22,2 mm	Pza. 25	
42-03-032	7" 180 x 3 x 22,2 mm	Pza. 25	
42-03-038	9" 230 x 3 x 22,2 mm	Pza. 25	
42-03-039	12" 300 x 3,5 x 22,2 mm	Pza. 25	

C-24 R "PLANO"



CODIGO	MEDIDAS	UN.	PRECIO + IVA
42-03-072	4,1/2" 115 x 3 x 22,2 mm	Pza. 25	
42-03-081	7" 180 x 3 x 22,2 mm	Pza. 25	
42-03-090	9" 230 x 3 x 22,2 mm	Pza. 25	

SUPERIOR

Gama de discos especialmente diseñados para aplicaciones y materiales específicos, logrando un máximo de rendimiento y calidad de corte y desbaste.

Discos de corte para acero inoxidable

AS-60 T-INOX "PLANO"

Precisión milimétrica

Permite excelente pulcritud en el corte, en un tiempo y con un esfuerzo mínimo. Trabajo sin vibraciones, exento de descoloramiento azul y sin formar rebabas.

Campo de aplicación: chapas finas (carrocerías, estanques y depósitos), cables de acero, tubos de acero afinado y de metales no férricos, perfiles de pared delgada.

1mm
GROSOR



CODIGO	MEDIDAS	UN.	PRECIO + IVA
42-03-044	4,1/2" 115 x 1 x 22,2 mm	Pza. 25	

Discos de corte universal

ACS-60 T-MULTI

Combina características de un disco para metal y uno de piedra

Por ello, permite el corte de metal, acero inoxidable y baldosas "sin cambiar de disco"

1.2 mm
GROSOR



CODIGO	MEDIDAS	UN.	PRECIO + IVA
42-03-005	4,1/2" 115 x 1,2 x 22,2 mm	Pza. 25	

AS-30-INOX "PLANO"

Fórmula abrasiva sin hierro, azufre y cloro, no forma corrosión

Campo de aplicación: disco especial para cortar acero inoxidable, buena duración también en acero normal.

2.2 mm
GROSOR



CODIGO	MEDIDAS	UN.	PRECIO + IVA
42-03-046	7" 180 x 2,2 x 22,2 mm	Pza. 25	

DIAMANTADOS

Discos de alta calidad en sus versiones mas comercializadas: desbaste, segmentado, turbo y lisos.

Discos de corte

QUALITY ST-7 "SEGMENTADO"

Corte en seco

Disco de diamante segmentado, sinterizado.

Campo de aplicación: uso universal para materiales de obras.



CODIGO	MEDIDAS	UN.	PRECIO + IVA
42-03-510	4,1/2" 115 x 2 x 22,2 mm / 9 seg.	Pza. 20	
42-03-520	7" 180 x 2,2 x 22,2 mm / 14 seg.	Pza. 20	

Discos para desbaste

DST BLUE SPEED "DESBASTE"

Disco de copa diamantado de alta velocidad



Ofrece la más alta tasa de remoción. El bajo peso y la geometría especial de sus segmentos permiten un cómodo y suave funcionamiento.

Campo de aplicación: para desbaste de hormigón y piedra, para eliminación de residuos de adhesivo en superficies.



CODIGO	MEDIDAS	UN.	PRECIO + IVA
42-03-560	4,1/2" 115 x 22,2 mm	Pza. -	

PERFECT TURBO F "TURBO"

Corte en seco

Disco sinterizado, para uso en material de obra. Su borde continuo genera cantos de corte limpios.

Campo de aplicación: hormigón, tejas de hormigón, granito, ladrillos.



CODIGO	MEDIDAS	UN.	PRECIO + IVA
42-03-530	4,1/2" 115 X 2,2 X 22,2 mm	Pza. 20	

LIJADORES

Discos de alta calidad diseñados para facilitar operaciones de lijado en materiales como acero, vidrio, plástico, madera, etc.

ALOX POWER

Para acero y madera

Disco lijador con soporte de fibra de vidrio



CODIGO	MEDIDAS	UN.	PRECIO + IVA
42-03-598	4,1/2"	Grano 40	Pza. 10
42-03-620	4,1/2"	Grano 60	Pza. 10
42-03-640	7"	Grano 60	Pza. 10
42-03-630	4,1/2"	Grano 80	Pza. 10
42-03-650	7"	Grano 80	Pza. 10
42-03-632	4,1/2"	Grano 120	Pza. 10

PERFECT G-C

Para vidrio, cerámica y piedra

Disco lijador con soporte de fibra de vidrio



CODIGO	MEDIDAS	UN.	PRECIO + IVA
42-03-670	4,1/2"	Grano 60	Pza. 10

SPECIAL J-AZA PARA ACERO Y ACERO INOX

Disco lijador con soporte plástico y ranuras de ventilación

Rápida instalación con hilo integrado M14 para esmeriladora.



CODIGO	MEDIDAS	UN.	PRECIO + IVA
42-03-679	4,1/2"	Grano - 40	Pza. 10
42-03-680	4,1/2"	Grano - 60	Pza. 10
42-03-682	4,1/2"	Grano - 80	Pza. 10

FIBRA-LIJA

Desoxidan, desbastan, alisan, excelentes para cualquier tipo de pulido. Se caracterizan por su alto rendimiento de desbaste y su larga duración. La gama se complementa con bases para discos de fibra.

Discos lija

DISCO LIJA

Para metal y madera



CODIGO	MEDIDAS	UN.	PRECIO + IVA
42-03-695	4,1/2"	Grano - 50	Pza. 25
42-03-702	4,1/2"	Grano - 80	Pza. 25
42-03-706	7"	Grano - 80	Pza. 25
42-03-710	4,1/2"	Grano - 120	Pza. 25
42-03-714	7"	Grano - 120	Pza. 25

DISCO LIJA CON VELCRO

Para metal y madera



CODIGO	MEDIDAS	UN.	PRECIO + IVA
42-03-721	4,1/2"	Grano - 80	Pza. 25
42-03-723	4,1/2"	Grano - 100	Pza. 25
42-03-725	4,1/2"	Grano - 120	Pza. 25

Soportes de goma

SOPORTES DE GOMA PARA ESMERILADORES



CODIGO	MEDIDAS	UN.	PRECIO + IVA
Para disco lija			
42-03-744	4,1/2"	Pza.	10
42-03-747	7"	Pza.	10
Para disco lija con velcro			
42-03-740	4,1/2"	Pza.	10
42-03-746	7"	Pza.	10

SOPORTES DE GOMA PARA TALADROS

Con vástago de 8 mm



CODIGO	MEDIDAS	UN.	PRECIO + IVA
Para disco lija			
42-03-743	5"	Pza.	10
Para disco lija con velcro			
42-03-742	5"	Pza.	10

RESPALDOS DE GOMA Y DISCOS LIJA PARA ESMERILADORA

En bolsa plástica, cantidad según medida



RESPALDO DE GOMA

Para esmeril



CODIGO	REF.	MEDIDA/TIPO	UN.		PRECIO + IVA
30-03-005	-	4.1/2"	Pza.	-	
30-03-010	-	5"	Pza.	-	

DISCO LIJA



CODIGO	REF.	MEDIDA/TIPO	UN.	MIN.	PRECIO + IVA
30-03-020	-	4.1/2" - #50	Pza.	25	
30-03-022	-	4.1/2" - #80	Pza.	25	
30-03-024	-	4.1/2" - #100	Pza.	25	
30-03-026	-	4.1/2" - #120	Pza.	25	

RESPALDO DE GOMA C/VELCRO

Para esmeril



CODIGO	REF.	MEDIDA/TIPO	UN.		PRECIO + IVA
30-03-000	-	4.1/2"	Pza.	-	

DISCO LIJA C/VELCRO



CODIGO	REF.	MEDIDA/TIPO	UN.	MIN.	PRECIO + IVA
30-03-050	-	4.1/2" - #60	Pza.	25	
30-03-052	-	4.1/2" - #80	Pza.	25	
30-03-054	-	4.1/2" - #100	Pza.	25	
30-03-056	-	4.1/2" - #120	Pza.	25	

PUNTAS IMANTADAS PARA TALADRO O ATORNILLADOR ELÉCTRICO

En caja individual



PUNTA POZIDRIVE

Caja 20 piezas

6.35 x 25 mm



CODIGO	MEDIDA/TIPO	UN.		MIN.	PRECIO + IVA
46-08-150	PZ2	Decena	20 dec.	-	

PUNTA PHILLIPS

6.35 x 25 mm

6.35 x 25 mm



CODIGO	MEDIDA/TIPO	UN.		MIN.	PRECIO + IVA
46-08-141	PH1	Decena	20 dec.	-	
46-08-144	PH2	Decena	20 dec.	-	

PUNTA PHILLIPS DOBLE

6.35 x 50 mm



CODIGO	MEDIDA/TIPO	UN.		MIN.	PRECIO + IVA
46-08-166	PH1	Decena	10 dec.	-	
46-08-168	PH2	Decena	10 dec.	-	

PUNTA PLANA

Caja 20 piezas

6.35 x 25 mm



CODIGO	MEDIDA/TIPO	UN.		MIN.	PRECIO + IVA
46-08-156	SL5	Decena	20 dec.	-	
46-08-154	SL6	Decena	20 dec.	-	

PUNTA COMBINADA PHILLIPS/PLANA

6.35 x 50 mm



CODIGO	MEDIDA/TIPO	UN.		MIN.	PRECIO + IVA
46-08-176	PH2 / SL6	Decena	10 dec.	-	

ADAPTADOR MAGNÉTICO, PARA TORNILLO CAB. HEXAGONAL

Display con 5 piezas

6.35 x 65 mm



CODIGO	MEDIDA/TIPO	UN.		MIN.	PRECIO + IVA
46-08-182	1/4"	Pza.	50	5	
46-08-184	5/16"	Pza.	50	5	
46-08-186	3/8"	Pza.	40	5	

SIERRA CIRCULAR PARA MADERA “GOLDCRAFT”

Dientes de carburo de tungsteno, con biselado alterno.

Capacidad máxima: 7000 rpm

CODIGO	MEDIDA/TIPO	DIENTES	UN.		PRECIO + IVA
46-02-164	7.1/4"	16	Pza.	25	
46-02-168	7.1/4"	24	Pza.	25	
46-02-172	7.1/4"	40	Pza.	25	



SIERRA CIRCULAR PARA MADERA “UYUSTOOLS”

Dientes de carburo de tungsteno, con biselado alterno.

Capacidad máxima: 9000 rpm

CODIGO	MEDIDA/TIPO	DIENTES	UN.		PRECIO + IVA
77-02-200	4.1/2"	18	Pza.	100	
77-02-201	4.1/2"	24	Pza.	100	
77-02-202	4.1/2"	40	Pza.	100	



CINTA PTFE, CARRETE AZUL

Rollo 5 m

CODIGO	MEDIDA/TIPO	UN.		MIN.	PRECIO + IVA
04-06-080	1/2"	Pza.	100	-	



CINTA PTFE ECOSA

Rollo 10 m

CODIGO	MEDIDA/TIPO	UN.		MIN.	PRECIO + IVA
04-06-101	1/2"	Pza.	100	-	
04-06-106	3/4"	Pza.	100	-	
04-06-112	1"	Pza.	100	-	



CINTA PTFE-GAS

Rollo 10 m

CODIGO	MEDIDA/TIPO	UN.		MIN.	PRECIO + IVA
04-06-198	1/2"	Pza.	100	-	



CINTA PTFE-GAS, CALIDAD PREMIUM

Rollo 10 m

CODIGO	MEDIDA/TIPO	UN.		MIN.	PRECIO + IVA
04-06-200	1/2"	Pza.	100	-	
04-06-203	3/4"	Pza.	100	-	



FLEXIBLES DE ACERO INOXIDABLE PARA GAS

CODIGO REF MEDIDA/TIPO UN. PRECIO + IVA

1/2" x 1/2" HI HI

1/2 HI cocina 1/2 HI llave de paso

08-06-040	EAG-N60	60 cm	Pza.	20
08-06-044	EAG-N100	100 cm	Pza.	20

1/2" x 7/8" HI HI

1/2 HI cocina 7/8 HI llave de paso

08-06-003	EAG-C60	60 cm	Pza.	20
08-06-006	EAG-C100	100 cm	Pza.	20

7/16" x 7/8" HE HE / para balón de 45 Kg.

Flexible con certificación para alta presión, únicos con norma en el mercado chileno
7/16 HE conexión a regulador - 7/8 HE conexión a llave de paso

08-06-021	EAG-D60	60 cm	Pza.	10
-----------	---------	-------	------	----

1/2" x 3/8" HI HI / para gas licuado

1/2 HI cocina - 3/8 HI hilo izq. regulador

08-06-050	EAG-O60	60 cm	Pza.	10
08-06-052	EAG-O100	100 cm	Pza.	10



FLEXIBLES DE ACERO INOXIDABLE PARA AGUA

CODIGO REF MEDIDA/TIPO UN. PRECIO + IVA

1/2" x 1/2" HI HI

08-06-190	AL-A25	25 cm	Pza.	25
08-06-155	AL-A30	30 cm	Pza.	50
08-06-157	AL-A40	40 cm	Pza.	50
08-06-159	AL-A55	55 cm	Pza.	50

1/2" x 1/2" HI HE

08-06-165	EAL-D25	25 cm	Pza.	25
08-06-167	EAL-D30	30 cm	Pza.	50
08-06-169	EAL-D40	40 cm	Pza.	50

1/2" x 7/8" HI HI / para WC / con tuerca plástica

08-06-176	AS-E30	30 cm	Pza.	50
-----------	--------	-------	------	----



Empresa mexicana con certificación ISO-9001:2000. Flexibles para gas, manguera de hule nitrilo, certificaciones UL Americana, CESMEC.

FLEXIBLES ACERO INOXIDABLE PARA CALEFONT Y TERMO

1/2" x 1/2" HI HI / para calefont

Diámetro interior de 1/2" para mayor flujo

08-06-154	EAB-P20	20 cm	Pza.	20	
08-06-156	EAB-P30	30 cm	Pza.	20	
08-06-182	EAB-P40	40 cm	Pza.	20	



1/2" x 1/2", HI HI, para termo

Diámetro interior de 11.4 mm para mayor flujo

CODIGO	REF	MEDIDA/TIPO	UN.		PRECIO + IVA
08-06-202	AB-C60	60 cm	Pza.	10	

FLEXIBLES VINÍLCOS PARA AGUA

CODIGO	REF	MEDIDA/TIPO	UN.		PRECIO + IVA
--------	-----	-------------	-----	--	--------------

1/2" x 7/8" HI HI / vinilo platino / para WC

08-06-184	VS-E30	30 cm	Pza.	25	
-----------	--------	-------	------	----	--

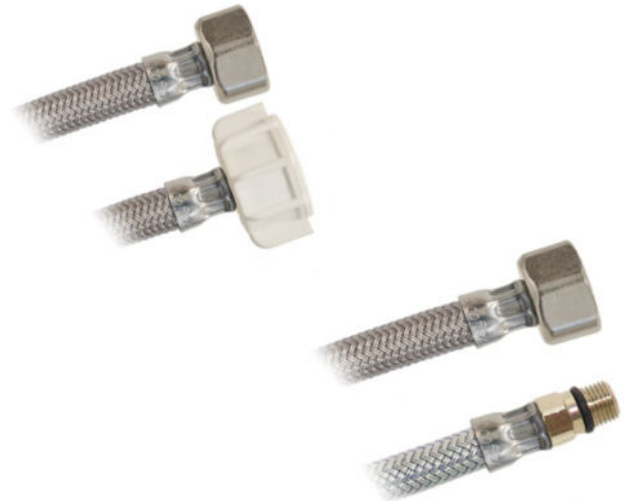

1/2" x M10 HI HE / vinilo platino / para lavaplatos

08-06-186	VL-M40	40 cm	Pza.	25	
-----------	--------	-------	------	----	--

3/4 x 3/4 HI HI / trenzado reforzado / para lavadora

CODIGO	MEDIDA/TIPO	UN.		MIN.	PRECIO + IVA
08-06-180	EVWB-B48	120 cm	Pza.	20	



REJILLA/DESAGÜE

Incluye **válvula antiolores VAO** que evita el retorno de malos olores e insectos en ausencia de agua

Instalación de la rejilla **a presión**

Cuerpo **resistente a la oxidación**

Fabricada con **materiales de alta calidad**

Fácil de remover y limpiar

Uso en duchas, desagües de piso, Lavanderías, etc

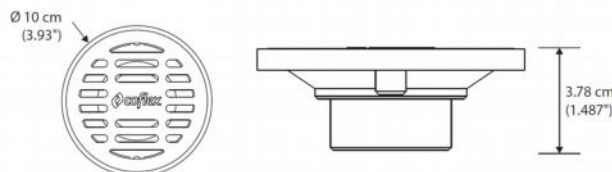
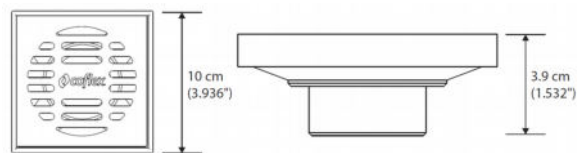

Rejilla gris de ABS

Para tubería de 50 mm (2")

CODIGO	MEDIDA/TIPO	UN.		MIN.	PRECIO + IVA
08-06-400	PC-150 / redondo	Pza.	-	-	
08-06-402	PC-160 / cuadrado	Pza.	-	-	



Rejilla cromada

Para tubería de 50 mm (2")

CODIGO	MEDIDA/TIPO	UN.		MIN.	PRECIO + IVA
08-06-404	PC-151 / redondo	Pza.	-	-	
08-06-406	PC-161 / cuadrado	Pza.	-	-	



Rejilla de acero inoxidable

Para tubería de 50 mm (2")

CODIGO	MEDIDA/TIPO	UN.		MIN.	PRECIO + IVA
08-06-408	PC-152 / redondo	Pza.	-	-	
08-06-410	PC-162 / cuadrado	Pza.	-	-	



CAPUCHÓN

Universal

Fabricado en PVC flexible gris

4 opciones:

- 1 Para trampas de lavabo
- 2 Para trampas de fregadero
- 3 Para conectar a tubo de PVC de 2"
- 4 Para conectar a tubo de PVC de 2" de campana

CODIGO	REF.	UN.		MIN.	PRECIO + IVA
08-06-412	P-B9030	Pza.	50	-	



Diagrama de Instalación

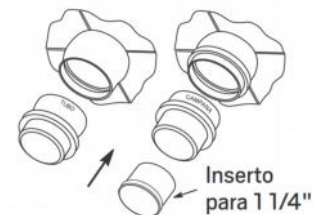

SELLO DE GOMA FLEXIBLE PARA WC

Con tacones de ajuste

Para tubería de 110 mm
(Tubería de 4"- diámetro interior 100 mm)

Manga de PVC Flexible
Sustituye al sello de cera
Vida útil igual a la del sanitario
Para tubería de PVC
No reduce el flujo
Sello hermético

CODIGO	REF.	UN.		MIN.	PRECIO + IVA
08-06-302	PB-201	Pza.	20	-	



Tacones para ajuste de altura



Uso Sin Tacones



Quando la descarga del sanitario está al mismo nivel del piso

SELLO DE GOMA FLEXIBLE PARA WC

Sustituye al anillo de cera

Para tubería de 110 mm
(Tubería de 4"- diámetro interior 100 mm)

Fabricado con PVC flexible
Sello hermético que evita filtraciones y el retorno de malos olores
Para tubos de PVC y hierro fundido

CODIGO	REF.	UN.		MIN.	PRECIO + IVA
08-06-300	PB-115	Pza.	24	-	



FLAPPER TRANSPARENTE

Cuerpo de PVC flexible con cadena acero inoxidable

Resistente al **agua dura** o con **exceso de cloro**
 Para válvulas de descarga **con o sin soportes laterales**
 Sello obturador
 Cuerpo **transparente**

Medidas:

Cuerpo 2"
 Cadena 15 cm



CODIGO	REF.	UN.		MIN.	PRECIO + IVA
08-06-602	P-B6025T	Pza.	25	-	

VÁLVULA DE LLENADO W.C. AJUSTABLE

Incluye flapper de PVC

Válvula de **fácil y preciso ajuste del nivel del agua** (ahorra agua)
 Pera **resistente al agua dura** o con **exceso de cloro**
 Ajustable a cualquier tipo de tanque

Funciona para:

Baja presión: Tinaco a 2 m de alto.
 Alta presión: Equipo hidroneumático.

Sistema Anti-sifón: En caso de falla en el suministro de agua, evita que el agua del tanque del sanitario se regrese a la edificación con el posible riesgo de contaminarla.

CODIGO	REF.	UN.		MIN.	PRECIO + IVA
08-06-600	PS-A002	Pza.	5	-	



PS-A002
 1 Válvula de admisión
 1 Pera de descarga

DESAGUE MULTIPOSICIÓN PARA LAVADO Y FREGADERO

Fabricado en polipropileno

Corrige hasta **13cm de desfaseamiento**
 Máximo ahorro de espacio debajo del lavabo o fregadero
 Ideal para condiciones de **drenaje desalineado** sin usar tramos corrugados
 Empaques cónicos de alta ingeniería que garantizan un mejor sello

Características:

Tuercas Ergonómicas para rosca de 1 1/2"
 Empaques 1 1/4" y 1 1/2"
 Césped 1 1/2"
 Bastón de Descarga Largo de 18 cm
 Brazo ajustable largo de 22 cm
 Chapetón Diámetro de 6.3 cm
 Extensión 1 1/2" y 1/4"
 Temperatura de Trabajo de 0°C a 90°C
 Presión Máxima hasta 5 PSI

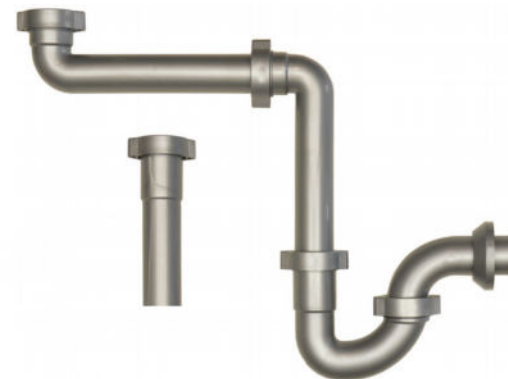
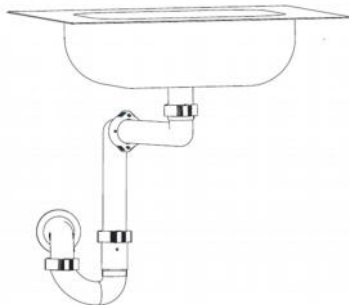

CODIGO	REF.	UN.		MIN.	PRECIO + IVA
08-06-604	P-B9029P	Pza.	10	-	

CABEZAL DUCHA BASIC



CODIGO	MEDIDA/TIPO	UN.		MIN.	PRECIO + IVA
33-06-036	Cabezal blanco	Pza.	100	-	
33-06-037	Cabezal cromado	Pza.	100	-	

DUCHA "PUNTOS VERDES"



CODIGO	MEDIDA/TIPO	UN.		MIN.	PRECIO + IVA
--------	-------------	-----	--	------	--------------

Cabezal cromado

33-06-034	-	Pza.	100	-	
-----------	---	------	-----	---	--

Cabezal cromado + flexible Acero inox. (en display)

33-06-022	-	Jgo.	20	-	
-----------	---	------	----	---	--

SOPORTE DUCHA



CODIGO	MEDIDA/TIPO	UN.		MIN.	PRECIO + IVA
33-06-038	Cromado	Pza.	-	-	
33-06-039	Blanco	Pza.	-	-	

LLAVE DE BOLA PARA JARDÍN

Manilla azul



CODIGO	MEDIDA/TIPO	UN.		MIN.	PRECIO + IVA
33-06-067	1/2" x 3/4"	Pza.	12	-	

LLAVE JARDÍN BRONCE, HE

Liviana



CODIGO	MEDIDA/TIPO	UN.		MIN.	PRECIO + IVA
33-06-059	1/2"	Pza.	10	-	

LLAVE PASO SOLDAR BRONCE



CODIGO	MEDIDA/TIPO	UN.		MIN.	PRECIO + IVA
33-06-044	1/2", liviana	Pza.	10	-	

FLEXIBLES DE ACERO INOX. A.P.

Diseño de alta flexibilidad, máxima resistencia para instalaciones sanitarias

HI/HI, 1/2" x 1/2"



CODIGO	MEDIDA/TIPO	UN.		MIN.	PRECIO + IVA
33-06-233	25 cm	Pza.	10	-	
33-06-234	30 cm	Pza.	10	-	
33-06-235	35 cm	Pza.	10	-	
33-06-236	40 cm	Pza.	10	-	
33-06-237	50 cm	Pza.	10	-	

HI/HE, 1/2" x 1/2"



CODIGO	MEDIDA/TIPO	UN.		MIN.	PRECIO + IVA
33-06-248	25 cm	Pza.	10	-	
33-06-249	30 cm	Pza.	10	-	
33-06-250	35 cm	Pza.	10	-	
33-06-251	40 cm	Pza.	10	-	
33-06-252	50 cm	Pza.	10	-	

HI/HI, 1/2" x 15/16" para "Fluidmaster"



CODIGO	MEDIDA/TIPO	UN.		MIN.	PRECIO + IVA
33-06-280	30 cm	Pza.	10	-	
33-06-281	30 cm tuerca plástica	Pza.	10	-	

Flexible para Monomandos



CODIGO	MEDIDA/TIPO	UN.		MIN.	PRECIO + IVA
33-06-283	30 cm	Pza.	10	-	
33-06-285	40 cm	Pza.	10	-	

Flexible para ducha



CODIGO	MEDIDA/TIPO	UN.		MIN.	PRECIO + IVA
33-06-220	150 cm	Pza.	50	-	
33-06-222	175 cm	Pza.	50	-	
33-06-224	200 cm	Pza.	50	-	

FLEXIBLES DE ALUMINIO A.P.

Diseño de alta flexibilidad, máxima resistencia para instalaciones sanitarias

HI/HI, 1/2" x 1/2"



CODIGO	MEDIDA/TIPO	UN.		MIN.	PRECIO + IVA
33-06-330	25 cm	Pza.	10	-	



DESAGÜE METÁLICO

Con rebalse



CODIGO	MEDIDA/TIPO	UN.		MIN.	PRECIO + IVA
33-06-155	1.1/4"	Pza.	60	-	

LLAVE PARA LAVAMANOS



CODIGO	MEDIDA/TIPO	UN.		MIN.	PRECIO + IVA
33-06-130	-	Pza.	2	-	

FLAPPER

Con cadena plástica



CODIGO	MEDIDA/TIPO	UN.		MIN.	PRECIO + IVA
33-06-005	-	Pza.	20	-	

COMBINACIÓN LAVAPLATOS "UNIVERSAL"

Incluye kit de instalación



CODIGO	MEDIDA/TIPO	UN.		MIN.	PRECIO + IVA
33-06-138	-	Pza.	-	-	

LLAVE DE BOLA ANGULAR CROMADA

Incluye kit de instalación



CODIGO	MEDIDA/TIPO	UN.		MIN.	PRECIO + IVA
33-06-058	1/2" x 1/2" sin flexible	Pza.	2	-	

FITTINGS PARA GASFITERÍA

Gran resistencia a la corrosión

Nº1

Boquilla recta latón HI



CODIGO	MEDIDA/TIPO	UN.		MIN.	PRECIO + IVA
33-06-140	1/2"	Pza.	100	10	
33-06-141	7/8"	Pza.	40	10	

Nº3

Adaptador latón HI hilo izquierdo



CODIGO	MEDIDA/TIPO	UN.		MIN.	PRECIO + IVA
33-06-142	3/8"	Pza.	100	10	

Nº5

Tee de bronce boquilla de 1/2"



CODIGO	MEDIDA/TIPO	UN.		MIN.	PRECIO + IVA
33-06-148	1/2"	Pza.	50	10	

Nº7

Boquilla recta latón HE



CODIGO	MEDIDA/TIPO	UN.		MIN.	PRECIO + IVA
33-06-144	1/2"	Pza.	50	10	

Nº8

Codo para boquilla de latón HI



CODIGO	MEDIDA/TIPO	UN.		MIN.	PRECIO + IVA
33-06-145	1/2"	Pza.	40	10	
33-06-146	7/8"	Pza.	50	10	

Nº9

Niple de bronce HE



CODIGO	MEDIDA/TIPO	UN.		MIN.	PRECIO + IVA
33-06-147	1/2" x 1/2"	Pza.	50	10	

**Conexión manguera HI de bronce
Con golilla**



CODIGO	MEDIDA/TIPO	UN.		MIN.	PRECIO + IVA
33-06-150	1/2" x 1/2"	Pza.	133	10	
33-06-151	3/4" x 3/4"	Pza.	100	10	

MONOMANDO LAVAMANOS

Incluye kit de instalación y flexibles



CODIGO	MEDIDA/TIPO	UN.		MIN.	PRECIO + IVA
33-06-160	-	Pza.	-	-	

MONOMANDO LAVAPLATOS CURVO

Incluye kit de instalación y flexibles.



CODIGO	MEDIDA/TIPO	UN.		MIN.	PRECIO + IVA
33-06-166	-	Pza.	-	-	

MONOMANDO DUCHA

Con ducha blanca y flex. Ac. Inox. 1,5 m

Incluye kit de instalación con adaptadores excéntricos para diferentes distancias entre las cañerías de alimentación pre-existentes.



CODIGO	MEDIDA/TIPO	UN.		MIN.	PRECIO + IVA
33-06-163	-	Pza.			

REPUESTO CARTUCHO CERÁMICO PARA MONOMANDOS



CODIGO	MEDIDA/TIPO	UN.		MIN.	PRECIO + IVA
33-06-210	35 mm	Pza.	-	-	

MONOMANDO TINA / DUCHA

Con ducha blanca y flex. Ac. Inox. 1,5 m

Incluye kit de instalación con adaptadores excéntricos para diferentes distancias entre las cañerías de alimentación pre-existentes.



CODIGO	MEDIDA/TIPO	UN.		MIN.	PRECIO + IVA
33-06-162	-	Pza.	-	-	

AIREADORES PARA MONOMANDOS



CODIGO	MEDIDA/TIPO	UN.		MIN.	PRECIO + IVA
33-06-207	3/4" HE	Pza.	10	-	
33-06-208	7/8" HE	Pza.	10	-	
33-06-209	7/8" HI	Pza.	10	-	

SELLO DE GOMA PARA WC

Con base adhesiva

Sello hermético que evita filtraciones y el retorno de malos olores

Fácil y limpia instalación

Para tubos de PVC y hierro fundido

Fabricado con PVC flexible



CODIGO	REF.	MEDIDA/TIPO	UN.		PRECIO + IVA
09-06-012	M31011G	110 mm - 4"	Pza.	60	

SELLO FLEXIBLE DE GOMA PARA WC

Corrige desfaseamientos

Evita filtraciones y malos olores

Para tubos de PVC y hierro fundido

Fabricado con PVC flexible

Base rígida con 4 tornillos de acero inoxidable

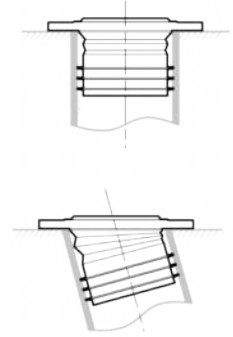

CODIGO	REF.	MEDIDA/TIPO	UN.		PRECIO + IVA
09-06-011	S10018	110 mm - 4"	Pza.	-	

ANILLO DE CERA PARA W.C.

Evita fugas líquidas y gaseosas

Con protección plástica para evitar daños al sello

Cera de duración extra larga, no se seca ni produce hongos

Guía para extender descarga del W.C. aumenta seguridad del sello

Caja litografiada con instrucciones al reverso



CODIGO	REF.	MEDIDA/TIPO	UN.		PRECIO + IVA
09-06-010	M60009	-	Pza.	54	

FLAPPER

Con cadena plástica



CODIGO	REF.	MEDIDA/TIPO	UN.		PRECIO + IVA
33-06-005	-	-	Pza.	20	

ASIENTO WC ECO, REDONDO

Incluye pernos de anclaje



CODIGO	REF.	MEDIDA/TIPO	UN.		PRECIO + IVA
09-06-046	D20024	Blanco	Pza.	10	

ASIENTO WC, ELONGADO

Incluye pernos de anclaje

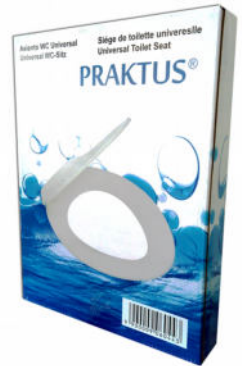

CODIGO	REF.	MEDIDA/TIPO	UN.		PRECIO + IVA
09-06-044	D20002	19"/ blanco	Pza.	10	

ASIENTO WC, REDONDO

Incluye pernos de anclaje



CODIGO	REF.	MEDIDA/TIPO	UN.		PRECIO + IVA
09-06-040	D20001	17"/ blanco	Pza.	10	

MANILLA ABS CON VARA METÁLICA PARA W.C.

Incluye colgador



CODIGO	REF.	MEDIDA/TIPO	UN.		PRECIO + IVA
09-06-015	B40006	-	Pza.	200	

MANILLA PLÁSTICA CROMADA PARA W.C.



CODIGO	REF.	MEDIDA/TIPO	UN.		PRECIO + IVA
09-06-020	B40004	-	Pza.	200	

KIT DE INSTALACIÓN WC

Para descarga al piso

Incluye:

1 Sello de cera antifugas y antihongos

1 Llave angular 100% metálica de 1/2" x 15/16"

1 manguera flexible de 12" HI HI 1/2" x 15/16" con flange

1 Juego de pernos de anclaje

1 adaptador 15/16" HE x 1/2" HI



CODIGO	REF.	MEDIDA/TIPO	UN.		PRECIO + IVA
09-06-013	Z0001	-	Jgo.	40	

SET DE ANCLAJE PARA WC

Incluye:

2 Tornillos de anclaje de 5 x 75

2 Tarugos

2 Golillas inferiores y 2 superiores

2 Gorros para tornillos



CODIGO	REF.	MEDIDA/TIPO	UN.		PRECIO + IVA
09-06-030	T40009	-	Jgo.	200	

BURLETE, CORDÓN DE CALAFATEO

Sello de 6 tiras para interior/exterior

Para usar en madera, plástico, metal, mampostería, vidrio y concreto

Gris pintable



CODIGO	REF.	MEDIDA/TIPO	UN.		PRECIO + IVA
09-06-300	601300343	3.2 mm x 9.1 m	Pza.	72	
09-06-302	601300341	3.2 mm x 27.4 m	Pza.	30	

CINTA SELLADORA AUTOADHESIVA

Con ribete decorativo

Para uso entre bañera y pared



CODIGO	REF.	MEDIDA/TIPO	UN.		PRECIO + IVA
09-06-400	0150	2.22 cm x 3.35 m	Pza.	60	

LLAVE TEMPORIZADORA PARA URINARIO

Tubo de 15 cm

Gran resistencia y durabilidad
Cartucho temporizado con cierre automático
Terminaciones cromadas decorativas



CODIGO	REF.	MEDIDA/TIPO	UN.		PRECIO + IVA
09-06-070	B30001	1/2"	Pza.	70	

JUEGO DUCHA 1 FUNCIÓN

Con flexible y soporte



CODIGO	REF.	MEDIDA/TIPO	UN.		PRECIO + IVA
09-06-054	ST70029B	1.8 m	Jgo.	40	

LLAVE TEMPORIZADORA PARA LAVAMANOS



CODIGO	REF.	MEDIDA/TIPO	UN.		PRECIO + IVA
09-06-072	T10001	1/2"	Pza.	40	

JUEGO DUCHA 3 FUNCIONES

Con flexible y soporte

30% de ahorro de agua
Con efecto de presurización
Diseño aerodinámico
Resistente a la corrosión y óxido
Flexible de acero inoxidable de 1.8 metros



CODIGO	REF.	MEDIDA/TIPO	UN.		PRECIO + IVA
09-06-050	S70020	3"	Jgo.	15	
09-06-052	S70001	4"	Jgo.	15	

MONOMANDO DUCHA

Con flexible y ducha

Fabricado en latón robusto
En caja individual
Incluye tornillería de anclaje



CODIGO	REF.	MEDIDA/TIPO	UN.		PRECIO + IVA
09-06-084	TB0033	-	Pza.	24	

MONOMANDO LAVAMANOS

Con flexibles y aireador

Fabricado en latón robusto
En caja individual
Incluye tornillería de anclaje



CODIGO	REF.	MEDIDA/TIPO	UN.		PRECIO + IVA
09-06-080	TB0034	-	Pza.	30	

MONOMANDO DUCHA/TINA

Con flexible y ducha

Fabricado en latón robusto
En caja individual
Incluye tornillería de anclaje



CODIGO	REF.	MEDIDA/TIPO	UN.		PRECIO + IVA
09-06-082	TB0032	-	Pza.	18	

MONOMANDO LAVAPLATOS

Con flexibles y aireador

Fabricado en latón robusto
En caja individual
Incluye tornillería de anclaje



CODIGO	REF.	MEDIDA/TIPO	UN.		PRECIO + IVA
09-06-086	TB0035	-	Pza.	20	

REJILLA DESAGÜE CUADRADA

Cuerpo ABS, rejilla acero inoxidable

Resistente a la corrosión
Ideal para desagües interiores y exteriores
Sello hidráulico que impide el retorno de olores

ESPECIFICACIONES:

Diámetros de salida: 1.3/4" (45mm) y 3" (78 mm)
Fondo: 57 mm



CODIGO	REF.	MEDIDA/TIPO	UN.		PRECIO + IVA
09-06-500	DL302	10 cm	Pza.	60	

REJILLA DESAGÜE CUADRADA

Acero inoxidable

Resistente a la corrosión
Ideal para desagües interiores y exteriores
Sello hidráulico que impide el retorno de olores

ESPECIFICACIONES:

Diámetros de salida: 1.3/4" (45mm) y 3" (78 mm)
Fondo: 51 mm

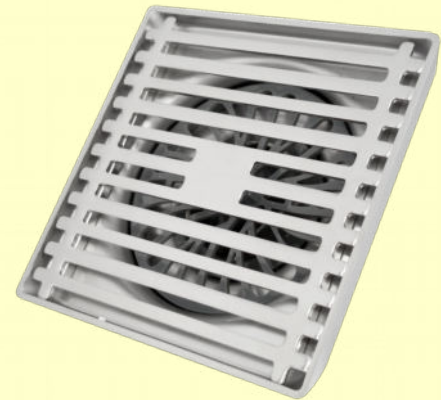

CODIGO	REF.	MEDIDA/TIPO	UN.		PRECIO + IVA
09-06-502	DL303	10 cm	Pza.	60	

REJILLA DESAGÜE REDONDA

Acero inoxidable

Resistente a la corrosión
Ideal para desagües interiores y exteriores
Sello hidráulico que impide el retorno de olores

ESPECIFICACIONES:

Diámetros de salida: 1.3/4" (45mm) y 2.3/4" (70 mm)
Fondo: 57 mm



CODIGO	REF.	MEDIDA/TIPO	UN.		PRECIO + IVA
09-06-510	DL304	Ø 10 cm	Pza.	60	

SOPLETES A GAS

Sólido porta cartucho metálico



- Livianos, portátiles y seguros
- Temperatura hasta 850°C
- Empuñadura anatómica de PVC de alta resistencia

Encendido manual



INCLUYE CARTUCHO DE GAS BUTANO



ENVASE CAJA LITOGRAFIADA CON INSTRUCCIONES DE USO

CODIGO	REF.	MEDIDA/TIPO	UN.	PRECIO + IVA
90-06-001	M-879	-	Pza. 20	

Encendido automático

Mediante sistema piezo-eléctrico, con botón en el mango



INCLUYE CARTUCHO DE GAS BUTANO



ENVASE CAJA LITOGRAFIADA CON INSTRUCCIONES DE USO

CODIGO	REF.	MEDIDA/TIPO	UN.	PRECIO + IVA
90-06-003	M-878	-	Pza. 20	

CARTUCHOS DE GAS

Mezcla Premium Butano/Propano



Para cocinillas, sopletes y lámparas

190 g



CODIGO	REF.	MEDIDA/TIPO	UN.	PRECIO + IVA
90-06-100	-	190 g	Caja 36 un	

500 g

Con válvula roscada 7/16"



CODIGO	REF.	MEDIDA/TIPO	UN.	PRECIO + IVA
90-06-110	-	500 g	Caja 12 un	

ACCESORIOS PARA LAMPARA A GAS

Vidrio termo-resistente



CODIGO	REF.	MEDIDA/TIPO	UN.	PRECIO + IVA
13-10-035	SD-B	-	Pza. 72	

Camisas



CODIGO	REF.	MEDIDA/TIPO	UN.	PRECIO + IVA
13-10-005	SD-B	200 Bujías (2 amarrias)	Pza. 12	
13-10-008	SD-B	300-400 bujías	Pza. 12	
13-10-011	SD-B	500-600 bujías	Pza. 12	

ESCUADRAS PARA REPISAS

Con pilar de anclaje ranurado

SOPORTE GRADUABLE

Cajas de 20 unidades, color blanco

CODIGO	MEDIDA/TIPO	UN.		MIN.	PRECIO + IVA
40-08-002	12 cm	Pza.	360	20	
40-08-004	17 cm	Pza.	240	20	
40-08-006	22 cm	Pza.	120	20	
40-08-008	27 cm	Pza.	120	20	
40-08-010	32 cm	Pza.	80	20	
40-08-012	37 cm	Pza.	80	20	
40-08-014	47 cm	Pza.	40	20	

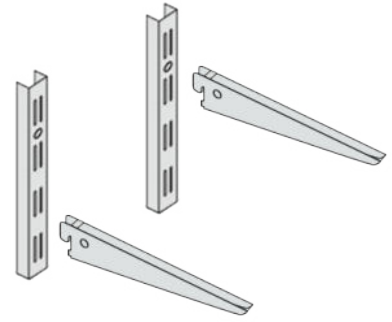

PILAR RANURADO

Atados 10 unidades, color blanco

CODIGO	MEDIDA/TIPO	UN.		MIN.	PRECIO + IVA
40-08-030	50 cm	Pza.	10	10	
40-08-032	100 cm	Pza.	10	10	
40-08-034	150 cm	Pza.	10	10	
40-08-036	200 cm	Pza.	10	10	



ESCUADRAS PARA REPISAS

Pintura epóxica, con nervatura de refuerzo de punta a punta

Color blanco

CODIGO	MEDIDA/TIPO	UN.		MIN.	PRECIO + IVA
34-20-130	3 x 4"	Pza.	24	24	
34-20-135	4 x 5"	Pza.	24	24	
34-20-140	5 x 6"	Pza.	24	24	
34-20-145	6 x 8"	Pza.	24	24	
34-20-155	8 x 10"	Pza.	24	24	
34-20-165	10 x 12"	Pza.	24	24	
34-20-175	12 x 14"	Pza.	24	24	



ESCUADRA PLANA

Acabado cincado

CODIGO	MEDIDA/TIPO	UN.		MIN.	PRECIO + IVA
46-02-220	40 x 40 x 13 x 1.5 mm	Pza.	12	12	
46-02-222	50 x 50 x 13 x 1.5 mm	Pza.	12	12	



Acabado dicromatado

CODIGO	MEDIDA/TIPO	UN.		MIN.	PRECIO + IVA
34-08-060	50 x 50 x 15 x 1,5 mm	Pza.	24	24	
34-08-062	60 x 60 x 15 x 1,5 mm	Pza.	24	24	
34-08-064	75 x 75 x 15 x 1,5 mm	Pza.	24	24	
34-08-066	100 x 100 x 15 x 1,5 mm	Pza.	24	24	



ESCUADRAS DE SILLA

Acabado dicromatado

Rectas

CODIGO	MEDIDA/TIPO	UN.		MIN.	PRECIO + IVA
34-08-040	30 x 30 x 15 x 1,5 mm	Pza.	-	12	
34-08-042	40 x 40 x 15 x 1,5 mm	Pza.	-	12	
34-08-044	50 x 50 x 15 x 1,5 mm	Pza.	-	12	
34-08-046	60 x 60 x 15 x 1,5 mm	Pza.	-	12	
34-08-048	70 x 70 x 20 x 1,5 mm	Pza.	-	12	
34-08-050	80 x 80 x 20 x 1,5 mm	Pza.	-	12	
34-08-052	100 x 100 x 20 x 1,5 mm	Pza.	-	12	



Redondeadas

CODIGO	MEDIDA/TIPO	UN.		MIN.	PRECIO + IVA
46-02-208	60 x 60 x 20 x 1.8 mm	Pza.	12	12	



PICAPORTE

Caja 12 unidades, acabado dicromatado

Incluye tornillería

CODIGO	REF.	MEDIDA/TIPO	UN.	MIN.	PRECIO + IVA
34-08-020	-	40 mm	Pza.	12	
34-08-022	-	50 mm	Pza.	12	
34-08-024	-	60 mm	Pza.	12	
34-08-026	-	80 mm	Pza.	12	
34-08-028	-	100 mm	Pza.	12	

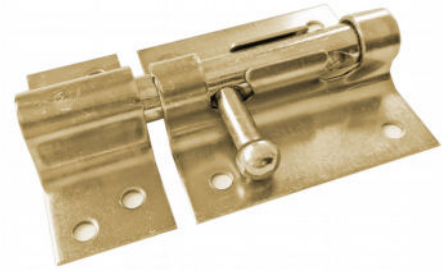

PICAPORTE PLANO

Caja 12 unidades, acabado dicromatado

Incluye tornillería

CODIGO	REF.	MEDIDA/TIPO	UN.	MIN.	PRECIO + IVA
34-08-010	-	3"	Pza.	12	
34-08-012	-	4"	Pza.	12	
34-08-014	-	5"	Pza.	12	
34-08-016	-	6"	Pza.	12	

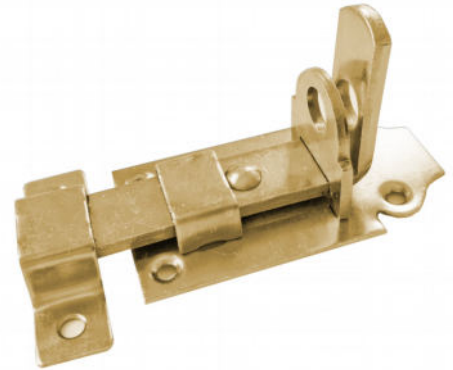

PORTACANDADO

Caja 12 unidades, acabado dicromatado

Incluye tornillería

CODIGO	REF.	MEDIDA/TIPO	UN.	MIN.	PRECIO + IVA
34-08-030	-	2"	Pza.	12	
34-08-032	-	3"	Pza.	12	
34-08-034	-	4"	Pza.	12	
34-08-036	-	5"	Pza.	12	



CADENA DE SEGURIDAD

Caja 12 unidades, acabado dicromatado

Incluye tornillería

CODIGO	REF.	MEDIDA/TIPO	UN.	MIN.	PRECIO + IVA
34-08-001	-	-	Pza.	12	



GUANTE ALGODÓN UNA CARA

Puntos de PVC



CODIGO	MEDIDA/TIPO	UN.		MIN.	PRECIO + IVA
49-22-154	Blanco, 450 g	Par	12	-	
49-22-160	Natural, 600 g	Par	12	-	

Caja de 300 pares

90-22-045	Blanco, 450 g	Caja	-	-	
90-22-050	Natural, 600 g	Caja	-	-	

GUANTE PALMA DE GOMA

Calidad superior



CODIGO	MEDIDA/TIPO	UN.		MIN.	PRECIO + IVA
49-22-165	10" / Anaranjado	Par	12	-	

Caja de 120 pares

90-22-090	10" / Anaranjado	Caja	-	-	
-----------	------------------	------	---	---	--

GUANTE LÁTEX NEGRO PARA ALBAÑIL

Con forro



CODIGO	MEDIDA/TIPO	UN.		MIN.	PRECIO + IVA
49-22-130	L	Par	12	-	

Caja de 240 pares

90-22-025	L	Caja	-	-	
-----------	---	------	---	---	--

GUANTE NITRILO VERDE



CODIGO	MEDIDA/TIPO	UN.		MIN.	PRECIO + IVA
46-22-020	12.1/2"	Par	12	-	

Caja de 120 pares

90-22-100	12.1/2"	Caja	-	-	
-----------	---------	------	---	---	--

GUANTE SOLDADOR ROJO

Forro franela

Excelente calidad y comodidad.
Lado superior de una pieza



CODIGO	MEDIDA/TIPO	UN.		MIN.	PRECIO + IVA
49-22-178	14"	Par	12	-	

Caja de 60 pares

90-22-070	14"	Caja	-	-	
-----------	-----	------	---	---	--

GUANTE DE DESCARNE SIN FORRO

Talla pequeña (niños)



CODIGO	MEDIDA/TIPO	UN.		MIN.	PRECIO + IVA
49-22-115	-	Par	12	-	

LENTE DE SEGURIDAD

Fabricados en policarbonato

Modelo 1



CODIGO	MEDIDA/TIPO	UN.	MIN	PRECIO + IVA
49-22-360	Oscuro	Pza.	100	-

Modelo 2



CODIGO	MEDIDA/TIPO	UN.	MIN	PRECIO + IVA
49-22-365	Transparente	Pza.	100	-

Modelo 3



CODIGO	MEDIDA/TIPO	UN.	MIN	PRECIO + IVA
49-22-336	Transparente	Pza.	100	-

Modelo 4



CODIGO	MEDIDA/TIPO	UN.	MIN	PRECIO + IVA
49-22-318	Transparente	Pza.	100	-
49-22-324	Amarillo	Pza.	100	-

LENTE DE SEGURIDAD ANTIRAYAS

Con protección UV y marco ajustable



CODIGO	MEDIDA/TIPO	UN.	MIN	PRECIO + IVA
49-22-370	Oscuro	Pza.	12	-

LENTE PARA SOLDADOR



CODIGO	MEDIDA/TIPO	UN.	MIN	PRECIO + IVA
49-22-350	Verde	Pza.	100	-

MÁSCARAS PARA SOLDAR

Visor alzable y arnés con ajuste

Material termoplástico de alta resistencia al calor y esquirlas incandescentes

Modelo 1



CODIGO	MEDIDA/TIPO	UN.	MIN	PRECIO + IVA
49-22-090	SG223	Pza.	-	-

Modelo 2



CODIGO	MEDIDA/TIPO	UN.	MIN	PRECIO + IVA
49-22-092	SG220	Pza.	-	-

PROTECTOR OÍDOS TIPO TAPÓN

Fabricado en espuma de poliuretano adaptable al oído

En bolsa individual



CODIGO	MEDIDA/TIPO	UN.		MIN	PRECIO + IVA
49-22-302	-	Par	25	25	

PROTECTOR OÍDOS TIPO AUDÍFONO



CODIGO	MEDIDA/TIPO	UN.		MIN	PRECIO + IVA
49-22-312	-	Pza.	100	-	

PROTECTOR OÍDOS TIPO TAPÓN

Fabricado en goma, con cordel para colgar al cuello

Cordel para colgado al cuello

Incluye bolsa con sellado hermético



CODIGO	MEDIDA/TIPO	UN.		MIN	PRECIO + IVA
49-22-300	-	Par	100	-	

MASCARILLA ANTIPOLVO DESECHABLE

Caja 50 unidades



CODIGO	MEDIDA/TIPO	UN.		MIN	PRECIO + IVA
49-22-306	-	Caja	-	-	

Revise también

CINTA DE EMPAQUE TRANSPARENTE

Paquetes de 6 unidades



CODIGO	MEDIDA/TIPO	UN.		MIN	PRECIO + IVA
49-28-010	40 m / transp.	Pza.	6	6	

ESPÁTULA MANGO MADERA

Hoja flexible de acero templado y rectificada

CODIGO	REF.	MEDIDA/TIPO	UN.		PRECIO + IVA
32-03-101	-	30 mm	Pza.	10	
32-03-103	-	40 mm	Pza.	10	
32-03-105	-	50 mm	Pza.	10	
32-03-107	-	60 mm	Pza.	10	
32-03-109	-	70 mm	Pza.	10	
32-03-111	-	80 mm	Pza.	10	
32-03-113	-	90 mm	Pza.	10	
32-03-115	-	100 mm	Pza.	10	
32-03-117	-	110 mm	Pza.	10	
32-03-119	-	120 mm	Pza.	10	
32-03-121	-	140 mm	Pza.	10	
32-03-123	-	160 mm	Pza.	10	



ESPÁTULA DENTADA “FINA”

Altura de diente 3 mm

Hojas de acero alto contenido de carbono, templados y dentados

CODIGO	REF.	MEDIDA/TIPO	UN.		PRECIO + IVA
32-03-166	-	140 mm	Pza.	5	



ESPÁTULA DENTADA “GRUESA”

Altura de diente 8 mm

Hojas de acero alto contenido de carbono, templados y dentados

CODIGO	REF.	MEDIDA/TIPO	UN.		PRECIO + IVA
32-03-160	-	140 mm	Pza.	5	



CINTA PARA JUNTURAS

CODIGO	REF.	MEDIDA/TIPO	UN.		PRECIO + IVA
46-03-210	-	48 mm x 20 m	Pza.	60	
46-03-212	-	48 mm x 45 m	Pza.	60	



SILICONA MULTIUSO

Sellador 100% silicona ácida con fungicida

Para acristalamiento, sellado de vidrio, carpintería, sellado en baños y cocinas, etc..

Excelente adherencia sobre vidrio, aluminio, cerámica, azulejos, superficies vitrificadas y otros materiales no porosos.

CODIGO	REF.	MEDIDA/TIPO	UN.		PRECIO + IVA
--------	------	-------------	-----	--	--------------

Transparente

89-03-005	-	280 ml	Pza.	Caja 24 un.	
-----------	---	--------	------	-------------	--

Blanca

89-03-007	-	280 ml	Pza.	Caja 24 un.	
-----------	---	--------	------	-------------	--

Negra

89-03-009	-	280 ml	Pza.	Caja 24 un.	
-----------	---	--------	------	-------------	--

Aluminio

89-03-012	-	280 ml	Pza.	Caja 24 un.	
-----------	---	--------	------	-------------	--



SELLADOR ACRÍLICO PINTABLE

Sellador multiuso blanco pintable

Capacidad de movimiento de 12.5% y resistente a temperaturas desde -25° a 80°.

El producto se seca completamente en 24 horas.

CODIGO	REF.	MEDIDA/TIPO	UN.		PRECIO + IVA
--------	------	-------------	-----	--	--------------

89-03-025	-	280 ml	Pza.	Caja 24 un.	
-----------	---	--------	------	-------------	--



ESPUMA DE POLIURETANO

Rellena, sella y aísla

Espuma de poliuretano, multiuso monocomponente

Para rellenos en general, detiene filtraciones de aire en marcos de ventanas y puertas, grietas en hormigón, sella y aísla térmica y acústicamente tuberías, caños, cañerías, techos y muros.

CODIGO	REF.	MEDIDA/TIPO	UN.		PRECIO + IVA
--------	------	-------------	-----	--	--------------

89-03-030	-	500 ml	Pza.	Caja 12 un.	
-----------	---	--------	------	-------------	--

MPS SÄGEN GMBH HERRAMIENTAS DE CORTE DE FABRICACIÓN ALEMANA

Productos elaborados con tecnología láser patentada.

Materias primas minuciosamente seleccionadas y traídas desde Suecia, Austria y Alemania, permiten un producto de calidad profesional para la ejecución de cortes precisos con acabados perfectos

DIN EN ISO 9001
Productos certificados



PATENT IPC B23D 65/00 NR. 10 2006 031 590
Sistema láser patentado para corte de acero endurecido de alta aleación a medida.

TODOS LOS PRODUCTOS EN EMPAQUE BLISTER, CON ORIFICIO PARA COLGAR



HOJAS SIERRA PARA CALADORA SET DE 5 UNIDADES

3103 5 unidades

PROFI-LINE

Cromo vanadio / toma tipo T / cortes rectos
Para maderas y aglomerados

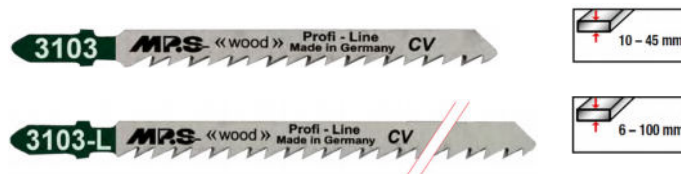

CODIGO	REF.	MEDIDA/TIPO	UN.		PRECIO + IVA
43-02-104	3103	100 x 8 mm / 6 dpp	Set 5	-	
43-02-116	3103-L	130 x 8 mm / 6 dpp	Set 5	-	

3101 / 3102 5 unidades

PROFI-LINE

Cromo vanadio / toma tipo T / cortes rectos
Para maderas, aglomerados y contrachapados



CODIGO	REF.	MEDIDA/TIPO	UN.		PRECIO + IVA
43-02-106	3101	100 x 10 mm / 10 dpp	Set 5	-	
43-02-108	3102	100 x 10 mm / 10 dpp	Set 5	-	

3401 5 unidades

PROFI-LINE

Cromo vanadio / toma tipo U / cortes rectos
Para maderas, aglomerados y contrachapados

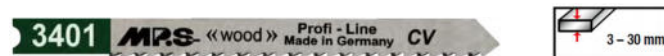

CODIGO	REF.	MEDIDA/TIPO	UN.		PRECIO + IVA
43-02-110	3401	100 x 10 mm / 10 dpp	Set 5	-	

3180

5 unidades

PROFI-LINE

Cromo vanadio / toma tipo T / cortes rectos
Dientes tipo diamante de 3 puntas
Para maderas, aglomerados y contrachapados



CODIGO	REF.	MEDIDA/TIPO	UN.	PRECIO + IVA
43-02-112	3180	115 x 8 mm / 8-10 dpp	Set 5	-

3141-F / 3101-F BIMETAL

5 unidades

PROFI-TOP-LINE

Bimetal / toma tipo T / cortes rectos
Para maderas, aglomerados y láminas



CODIGO	REF.	MEDIDA/TIPO	UN.	PRECIO + IVA
43-02-302	3141-F	80 x 8 mm / 13 dpp	Set 5	-
43-02-304	3101-F	100 x 8 mm / 10 dpp	Set 5	-

3109

5 unidades

CLASSIC-LINE

Cromo vanadio / toma tipo T / cortes curvos
Para maderas, aglomerados y contrachapados



CODIGO	REF.	MEDIDA/TIPO	UN.	PRECIO + IVA
43-02-202	3109	75 x 8 mm / 12 dpp	Set 5	-

3104 ALTA VELOCIDAD

5 unidades

PROFI-LINE

Cromo vanadio / toma tipo T / cortes rectos
Para maderas, aglomerados y contrachapados

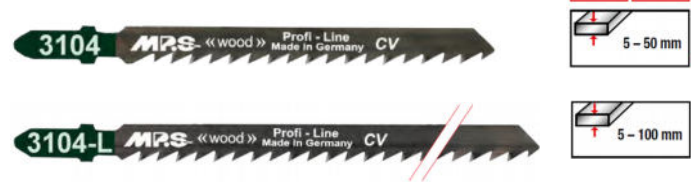

CODIGO	REF.	MEDIDA/TIPO	UN.	PRECIO + IVA
43-02-102	3104	100 x 6 mm / 6 dpp	Set 5	-
43-02-114	3104-L	130 x 6 mm / 6 dpp	Set 5	-

3106 ALTA VELOCIDAD

5 unidades

CLASSIC-LINE

Cromo vanadio / toma tipo T / cortes rectos
Para maderas y aglomerados



CODIGO	REF.	MEDIDA/TIPO	UN.	PRECIO + IVA
43-02-206	3106	100 x 8 mm / 8 dpp	Set 5	-

3406 ALTA VELOCIDAD

5 unidades

CLASSIC-LINE

Cromo vanadio / toma tipo U / cortes rectos
Para maderas y aglomerados



CODIGO	REF.	MEDIDA/TIPO	UN.	PRECIO + IVA
43-02-204	3406	100 x 8 mm / 8 dpp	Set 5	-

3411

5 unidades

CLASSIC-LINE

HSS / toma tipo U / cortes rectos
Para lámina de acero



CODIGO	REF.	MEDIDA/TIPO	UN.	PRECIO + IVA
43-20-102	3411	75 x 8 mm / 21 dpp	Set 5	-

3116

5 unidades

CLASSIC-LINE

HSS / toma tipo T / cortes rectos
Para metales no ferrosos, aluminio, plástico y acrílicos



CODIGO	REF.	MEDIDA/TIPO	UN.	PRECIO + IVA
43-20-132	3116	100 x 8 mm / 12 dpp	Set 5	-

3113

5 unidades

CLASSIC-LINE

HSS / toma tipo T / cortes rectos
Para lámina de acero

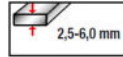

CODIGO	REF.	MEDIDA/TIPO	UN.	PRECIO + IVA
43-20-112	3113	75 x 8 mm / 12 dpp	Set 5	-

3118 ALTA VELOCIDAD

5 unidades

CLASSIC-LINE

HSS / toma tipo T / cortes rectos
Para láminas y tuberías de acero, perfiles abiertos, metales no ferrosos y aluminio



CODIGO	REF.	MEDIDA/TIPO	UN.	PRECIO + IVA
43-20-142	3118	100 x 8 mm / 8 dpp	Set 5	-

3111

5 unidades

CLASSIC-LINE

HSS / toma tipo T / cortes rectos
Para lámina de acero



CODIGO	REF.	MEDIDA/TIPO	UN.	PRECIO + IVA
43-20-122	3111	75 x 8 mm / 21 dpp	Set 5	-

3114

5 unidades

CLASSIC-LINE

HSS / toma tipo T / cortes rectos
Para láminas y tuberías de acero, perfiles abiertos, metales no ferrosos y aluminio



CODIGO	REF.	MEDIDA/TIPO	UN.	PRECIO + IVA
43-20-144	3114	132 x 8 mm / 21 dpp	Set 5	-

3111-F

5 unidades

Bimetal / toma tipo T / cortes rectos
Para Acero inoxidable y láminas de acero

PROFI-TOP-LINE

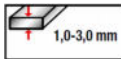

CODIGO	REF.	MEDIDA/TIPO	UN.	PRECIO + IVA
43-20-304	3111-F	75 x 8 mm / 21 dpp	Set 5	-

3175-F "ALTA VELOCIDAD"

5 unidades

Bimetal / toma tipo T / cortes rectos
Para acero inoxidable, láminas y tuberías de acero, metales no ferrosos y aluminio

PROFI-TOP-LINE



CODIGO	REF.	MEDIDA/TIPO	UN.	PRECIO + IVA
43-20-306	3175-F	100 x 8 mm / 10 - 20 dpp	Set 5	-

3114-F

5 unidades

Bimetal / toma tipo T / cortes rectos
Para láminas y tuberías de acero, metales no ferrosos, aluminio, perfiles abiertos, plásticos reforzados, epoxi y materiales sándwich

PROFI-TOP-LINE



CODIGO	REF.	MEDIDA/TIPO	UN.	PRECIO + IVA
43-20-308	3114-F	132 x 8 mm / 21 dpp	Set 5	-

HOJAS SIERRA BIMETAL

HSS Bimetal
Para todo tipo de metales, acero inoxidable,
Resistente a roturas



CODIGO	REF.	MEDIDA/TIPO	UN.	PRECIO + IVA
--------	------	-------------	-----	--------------

100 unidades (en caja plástica)

43-20-508	6620-18	300 mm / 12" / 18 dpp	Cien	-
43-20-510	6620-24	300 mm / 12" / 24 dpp	Cien	-
43-20-512	6620-32	300 mm / 12" / 32 dpp	Cien	-

10 unidades (atados)

90-20-508	6620-18	300 mm / 12" / 18 dpp	Dec.	-
90-20-510	6620-24	300 mm / 12" / 24 dpp	Dec.	-
90-20-512	6620-32	300 mm / 12" / 32 dpp	Dec.	-

HOJAS SIERRA BIMETAL COBALTO

VARIÖZAHN

HSS Bimetal 8% cobalto / altamente flexible
Para todo tipo de metales, especialmente acero inoxidable V2A
Resistente a roturas



CODIGO	REF.	MEDIDA/TIPO	UN.	PRECIO + IVA
--------	------	-------------	-----	--------------

100 unidades (en caja plástica)

43-20-514	6620-20/24	300 mm / 12" / 20-24 dpp	Cien	-
-----------	------------	--------------------------	------	---

10 unidades (atados)

90-20-514	6620-20/24	300 mm / 12" / 20-24 dpp	Dec.	-
-----------	------------	--------------------------	------	---

HOJAS PARA SIERRA SABLE

4011

5 unidades

WOOD

Cromo vanadio / toma tipo universal 1/2" / cortes curvos
Para maderas y aglomerados

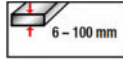

CODIGO	REF.	MEDIDA/TIPO	UN.	PRECIO + IVA
43-02-402	4011	150 x 19 mm / 6 dpp	Set 5	-

4021 ALTA VELOCIDAD

5 unidades

WOOD-FAST

Cromo vanadio / toma tipo universal 1/2" / cortes curvos
Para maderas

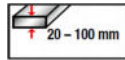

CODIGO	REF.	MEDIDA/TIPO	UN.	PRECIO + IVA
43-02-400	4021	150 x 19 mm / 3 dpp	Set 5	-

4020 ALTA VELOCIDAD

5 unidades

WOOD-FAST

Cromo vanadio / toma tipo universal 1/2"
Para madera en bruto

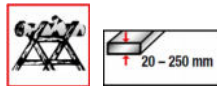

CODIGO	REF.	MEDIDA/TIPO	UN.	PRECIO + IVA
43-02-406	4020	300 x 19 mm / 3 dpp	Set 5	-

4084-2

2 UNIDADES

CARBIDE

Grano de carburo abrasivo / toma tipo universal 1/2"
Para tubería de hierro, azulejos y vidrio

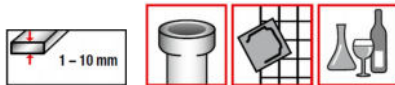

CODIGO	REF.	MEDIDA/TIPO	UN.	PRECIO + IVA
43-11-202	4084-2	230 x 19 mm	Set 2	-

4046 CORTES LIMPIOS

5 unidades

WOOD-CLEAN

Cromo vanadio / toma tipo universal 1/2"
Dientes tipo diamante de 3 puntas
Para maderas y aglomerados

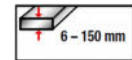

CODIGO	REF.	MEDIDA/TIPO	UN.	PRECIO + IVA
43-02-404	4046	200 X 19 mm / 6-10 dpp	Set 5	-

4055 MADERA VERDE

5 unidades

WOOD-GREEN

Cromo vanadio / toma tipo universal 1/2"
Para madera verde

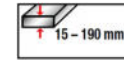

CODIGO	REF.	MEDIDA/TIPO	UN.	PRECIO + IVA
43-40-104	4055	240 x 19 mm / 4 dpp	Set 5	-

4052 MADERA VERDE

5 unidades

WOOD-GREEN

Cromo vanadio / toma tipo universal 1/2"
Para madera verde y ramas

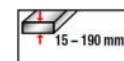

CODIGO	REF.	MEDIDA/TIPO	UN.	PRECIO + IVA
43-11-102	4052	240 x 19 mm / 4-5 dpp	Set 5	-

4015 BIMETAL

5 unidades

WOOD+NAILS

HSS Bimetal 8% cobalto / toma tipo universal 1/2"
Para maderas con o sin clavos

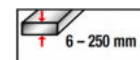

CODIGO	REF.	MEDIDA/TIPO	UN.	PRECIO + IVA
43-02-502	4015	300 x 19 mm / 6 dpp	Set 5	-

4434
5 unidades

WOOD+NAILS

HSS Bimetal 8% cobalto / toma tipo universal 1/2"
Para maderas con o sin clavos y tubos de acero

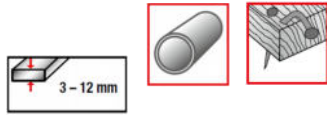

CODIGO	REF.	MEDIDA/TIPO	UN.	PRECIO + IVA
43-02-504	4434	230 x 19 mm / 10 dpp	Set 5	-

4434-VP
5 unidades

VARIÖZAHN

METAL UNIVERSAL-WOOD+NAILS

HSS Bimetal 8% cobalto / toma tipo universal 1/2" / cortes rectos
Para madera con o sin clavos, palets, acero, tuberías de acero, plasticos reforzados, epoxi

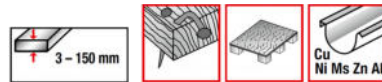

CODIGO	REF.	MEDIDA/TIPO	UN.	PRECIO + IVA
43-20-502	4434-VP	230 x 19 mm / 10-14 dpp	Set 5	-

4442 / 4444
5 unidades

DEMOLITION

HSS Bimetal 8% cobalto / toma tipo universal 1/2" / cortes rectos / ángulos precisos
Especial para demoliciones, madera con o sin clavos, marcos de ventanas, epoxi, plásticos reforzados



CODIGO	REF.	MEDIDA/TIPO	UN.	PRECIO + IVA
43-20-602	4442	150 x 19 mm / 6 dpp	Set 5	-
43-20-506	4444	230 x 19 mm / 6 dpp	Set 5	-

4411 / 4416
5 unidades

METAL-MEDIUM

HSS Bimetal 8% cobalto / toma tipo universal 1/2" / cortes rectos
Para acero inoxidable, aleaciones metal/acero, láminas y tuberías de acero, perfiles abiertos y cerrados

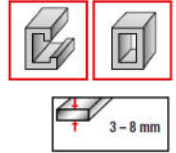

CODIGO	REF.	MEDIDA/TIPO	UN.	PRECIO + IVA
43-20-402	4411	150 x 19 mm / 14 dpp	Set 5	-
43-20-404	4416	230 x 19 mm / 14 dpp	Set 5	-

4445
5 unidades

METAL-HEAVY

HSS Bimetal 8% cobalto / toma tipo universal 1/2" / cortes rectos / ángulos precisos
Para hierro fundido, tuberías de acero, perfiles abiertos y cerrados, metales no ferrosos y aluminio

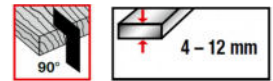

CODIGO	REF.	MEDIDA/TIPO	UN.	PRECIO + IVA
43-20-504	4445	230 x 19 mm / 8 dpp	Set 5	-

4408 / 4409 / 4465 HOJA FLEXIBLE
5 unidades

EXTRA-METAL-FLEXIBLE

HSS Bimetal 8% cobalto / toma tipo universal 1/2" / cortes rectos / ángulos precisos
Para acero inoxidable, aleaciones metal/acero, láminas y tuberías de acero, perfiles abiertos y cerrados



CODIGO	REF.	MEDIDA/TIPO	UN.	PRECIO + IVA
43-20-604	4408	150 x 25,40 mm / 14 dpp	Set 5	-
43-20-606	4409	225 x 25,40 mm / 14 dpp	Set 5	-
43-20-608	4465	300 x 25,40 mm / 10 dpp	Set 5	-

LINEA STARLOCK

3903 / 3904 BIMETAL

Bimetal / toma tipo starlock
Para maderas con o sin clavos, aglomerados, plásticos, láminas y placas de yeso



CODIGO	REF.	MEDIDA/TIPO	UN.	PRECIO + IVA
43-02-602	3903	30 x 10 mm	Pza.	-
43-02-604	3904	34 x 20 mm	Pza.	-

3901

Cromo vanadio / toma tipo starlock
Para maderas, aglomerados, láminas, placas de yeso y plásticos



CODIGO	REF.	MEDIDA/TIPO	UN.	PRECIO + IVA
43-02-606	3901	50 x 35 mm	Pza.	-

3902 CORTES CURVOS

Cromo vanadio / toma tipo starlock
Para maderas, aglomerados, láminas, placas de yeso y plásticos



CODIGO	REF.	MEDIDA/TIPO	UN.	PRECIO + IVA
43-02-608	3902	65 x 55 mm	Pza.	-

3907 BIMETAL

Alta velocidad, cortes limpios

Bimetal / toma tipo starlock
Para maderas, aglomerados, láminas y placas de yeso



Dientes rectificadas para cortes rápidos y limpios

CODIGO	REF.	MEDIDA/TIPO	UN.	PRECIO + IVA
43-02-610	3907	50 x 35 mm	Pza.	-

3905 / 3906 BIMETAL

Bimetal / toma tipo starlock
Para maderas con o sin clavos, aglomerados, plásticos, láminas y placas de yeso



CODIGO	REF.	MEDIDA/TIPO	UN.	PRECIO + IVA
43-02-612	3905	50 x 35 mm	Pza.	-
43-02-614	3906	50 x 50 mm	Pza.	-

3910 / 3911 / 3912 MADERA Y METAL

Bimetal / toma tipo starlock
Para latón hasta 2 mm, aluminio, metales no ferrosos, maderas, plásticos, y placas de yeso



CODIGO	REF.	MEDIDA/TIPO	UN.	PRECIO + IVA
43-02-702	3910	50 x 28 mm	Pza.	-
43-02-706	3911	50 x 44 mm	Pza.	-
43-02-704	3912	50 x 30 mm	Pza.	-

SIERRA CIRCULAR SEGMENTADA

Cortes finos y limpios, para madera y metal

HSS / toma tipo starlock

Para latón hasta 1 mm, metales no ferrosos, maderas, plásticos y fibra de carbono

Línea de corte limpia y delgada

Compatibilidad:
Fein 63502106210



CODIGO	REF.	MEDIDA/TIPO	UN.	PRECIO + IVA
43-02-708	3913	85 mm	Pza.	-

BASE PARA HERRAMIENTA MULTIUSO

Almohadilla de respaldo fabricada en plástico perforado/ toma tipo starlock
Evita marcas en el material

Compatibilidad:
Bosch AVZ 93 G
Fein 63806136210



CODIGO	REF.	MEDIDA/TIPO	UN.	PRECIO + IVA
43-04-010	3920	80 mm	Pza.	-

SIERRA CIRCULAR BIMETAL

Para madera y metal

Bimetal / toma tipo starlock

Para latón hasta 1 mm, metales no ferrosos, maderas, plásticos y fibra de carbono

Compatibilidad:
Bosch ACZ 85 EB
Fein 63502174210



CODIGO	REF.	MEDIDA/TIPO	UN.	PRECIO + IVA
43-20-610	3914-1	85 mm	Pza.	-

SET DE LIJAS PARA HERRAMIENTA MULTIUSO

5 unidades

Compatibilidad:
Fein 63717109013

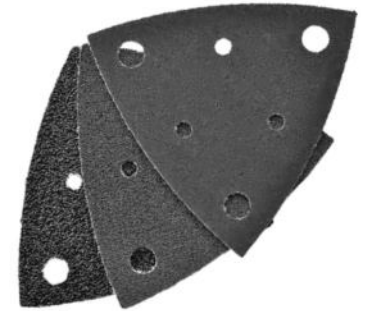

CODIGO	REF.	MEDIDA/TIPO	UN.	PRECIO + IVA
43-04-012	3921	G60 / 80 mm	Set 5	-
43-04-014	3922	G120 / 80 mm	Set 5	-
43-04-016	3923	G180 / 80 mm	Set5	-

RASPADOR FLEXIBLE

Cromo vanadio / toma tipo starlock

Para aflojar juntas de silicona, revestimientos de suelos, pintura y residuos adhesivos

Compatibilidad:
Bosch ATZ 52 SFC
Fein 63903165210



CODIGO	REF.	MEDIDA/TIPO	UN.	PRECIO + IVA
43-04-002	3927	34 x 52 mm	Pza.	-



CORTACÍCULOS BIMETAL

HSS Bimetal / toma standard

Para acero inoxidable, aleaciones metal/acero, madera, madera con clavos y plásticos

GUÍA PARA CORTACÍCULOS

Para cortacírculos de 14 a 30 mm (9/16 - 13/16")



CODIGO	REF.	MEDIDA/TIPO	UN.	PRECIO + IVA
43-27-006	5503	11 mm - 7/16"	Pza.	-

Para cortacírculos de 32 a 210 mm (1.1/4" x 8.1/4")



CODIGO	REF.	MEDIDA/TIPO	UN.	PRECIO + IVA
43-27-010	5505	11 mm - 7/16"	Pza.	-

CODIGO	REF.	MEDIDA/TIPO	UN.	PRECIO + IVA
43-20-802	5016	16 mm	Pza.	-
43-20-804	5019	19 mm	Pza.	-
43-20-806	5020	20 mm	Pza.	-
43-20-808	5021	21 mm	Pza.	-
43-20-810	5022	22 mm	Pza.	-
43-20-812	5024	24 mm	Pza.	-
43-20-814	5025	25 mm	Pza.	-
43-20-816	5027	27 mm	Pza.	-
43-20-818	5029	29 mm	Pza.	-
43-20-820	5030	30 mm	Pza.	-
43-20-822	5032	32 mm	Pza.	-
43-20-824	5033	33 mm	Pza.	-
43-20-826	5035	35 mm	Pza.	-
43-20-828	5038	38 mm	Pza.	-
43-20-830	5040	40 mm	Pza.	-
43-20-832	5041	41 mm	Pza.	-
43-20-834	5043	43 mm	Pza.	-
43-20-836	5044	44 mm	Pza.	-
43-20-838	5045	45 mm	Pza.	-
43-20-840	5046	46 mm	Pza.	-
43-20-842	5048	48 mm	Pza.	-
43-20-844	5050	50 mm	Pza.	-
43-20-846	5051	51 mm	Pza.	-
43-20-848	5052	52 mm	Pza.	-
43-20-850	5054	54 mm	Pza.	-
43-20-852	5055	55 mm	Pza.	-
43-20-854	5057	57 mm	Pza.	-
43-20-856	5059	59 mm	Pza.	-
43-20-858	5060	60 mm	Pza.	-
43-20-860	5064	64 mm	Pza.	-
43-20-862	5065	65 mm	Pza.	-
43-20-864	5068	68 mm	Pza.	-
43-20-866	5070	70 mm	Pza.	-
43-20-868	5076	76 mm	Pza.	-
43-20-870	5079	79 mm	Pza.	-
43-20-872	5083	83 mm	Pza.	-
43-20-874	5089	89 mm	Pza.	-
43-20-876	5092	92 mm	Pza.	-
43-20-878	5100	100 mm	Pza.	-

Nueva línea de cuchillos profesionales de alta calidad

Acero inoxidable **3Cr13**, con una dureza de **HRC52** o más, garantizada.
Excelente mantención del filo.
Mangos **antibacteriales**.



CUCHILLO PARA PAN

CODIGO	REF.	MEDIDA/TIPO	UN.		PRECIO + IVA
64-12-111	054	12"	Pza.	-	



CUCHILLO CARNICERO

CODIGO	REF.	MEDIDA/TIPO	UN.		PRECIO + IVA
64-12-025	242	8"	Pza.	10	
64-12-027	241	10"	Pza.	10	
64-12-029	240	12"	Pza.	10	



CUCHILLO COCINERO

CODIGO	REF.	MEDIDA/TIPO	UN.		PRECIO + IVA
64-12-045	023	8"	Pza.	6	
64-12-047	022	10"	Pza.	10	



CUCHILLO PARA DESCUERAR

CODIGO	REF.	MEDIDA/TIPO	UN.		PRECIO + IVA
64-12-064	303	6"	Pza.	10	



CUCHILLO PARA DESHUESAR

CODIGO	REF.	MEDIDA/TIPO	UN.		PRECIO + IVA
64-12-080	289	6"	Pza.	10	



CHAIRAS PROFESIONALES CILÍNDRICAS

Excelente resultado de afilado, modelo robusto

CODIGO	REF.	MEDIDA/TIPO	UN.		PRECIO + IVA
64-12-007	170	10"	Pza.	50	



Nueva línea de cuchillos profesionales de alta calidad

Acero inoxidable **3Cr13**, con una dureza de **HRC52** o más, garantizada.
Excelente mantención del filo.
Mangos **antibacteriales**.



CUCHILLOS PARA CARNES

En display de 4 unidades

Mango madera dura, resistente al lavado
Hoja pulido espejo

CODIGO	REF.	MEDIDA/TIPO	UN.		PRECIO + IVA
64-12-200	-	5"	Set4	6	



CUCHILLO PELADOR 359

Venta mínima: 12 unidades

CODIGO	REF.	MEDIDA/TIPO	UN.		PRECIO + IVA
64-12-096	359	3,5"	Pza.	24	



CUCHILLO PELADOR 363

Venta mínima: 12 unidades

CODIGO	REF.	MEDIDA/TIPO	UN.		PRECIO + IVA
64-12-100	363	4,5"	Pza.	24	



5500 Series

Linea de cuchillos profesionales para distintos usos
Mangos sintéticos, higiene total, apto para lavavajillas.

5515, DESHUESAR

CODIGO	REF.	MEDIDA/TIPO	UN.		PRECIO + IVA
11-12-385	5515-6	6"	Pza.	12	



5515B, RETIRADO DE TRUTRO DE POLLO

CODIGO	REF.	MEDIDA/TIPO	UN.		PRECIO + IVA
11-12-387	5515B	6"	Pza.	12	



5520, CARNICERO

CODIGO	REF.	MEDIDA/TIPO	UN.		PRECIO + IVA
11-12-400	5520-10	10"	Pza.	12	
11-12-405	5520-12	12"	Pza.	12	



5510, COCINERO

CODIGO	REF.	MEDIDA/TIPO	UN.		PRECIO + IVA
11-12-370	5510-8	8"	Pza.	12	
11-12-375	5510-10	10"	Pza.	12	



Mangos en colores

11-12-366	5510	8" Rojo	Pza.	12	
11-12-368	5510AZ	8" Azul	Pza.	12	
11-12-369	5510AM	8" Amarillo	Pza.	12	



5610, COCINERO

Hoja más ancha con pulido espejo, mango sólido y más ancho

CODIGO	REF.	MEDIDA/TIPO	UN.		PRECIO + IVA
11-12-378	5610-12	12"	Pza.	12	



5519, DESCUERAR

CODIGO	REF.	MEDIDA/TIPO	UN.		PRECIO + IVA
11-12-395	5519-6	6"	Pza.	12	



CHAIRA

Mango blanco, con argolla para colgar

CODIGO	REF.	MEDIDA/TIPO	UN.		PRECIO + IVA
11-12-110	-	8"	Pza.	10	
11-12-113	-	10"	Pza.	10	
11-12-115	-	12"	Pza.	10	





TIJERA COCINA



CODIGO	REF.	MEDIDA/TIPO	UN.		PRECIO + IVA
24-13-046	795	8"	Pza.	12	

TIJERA PELUQUERO

Una hoja microdentada



CODIGO	REF.	MEDIDA/TIPO	UN.		PRECIO + IVA
24-14-015	842	6"	Pza.	12	

TIJERA PARA UÑAS DE BEBÉ



CODIGO	REF.	MEDIDA/TIPO	UN.		PRECIO + IVA
24-15-005	845C	3.1/2"	Pza.	12	

TIJERA CUTÍCULA CURVA



CODIGO	REF.	MEDIDA/TIPO	UN.		PRECIO + IVA
24-15-010	852	3.1/2"	Pza.	12	

ALICATE CUTÍCULA



CODIGO	REF.	MEDIDA/TIPO	UN.		PRECIO + IVA
24-15-020	911	4.1/2"	Pza.	12	

TIJERA HILANDERA

Acabado níquel cromo para deshilar



CODIGO	REF.	MEDIDA/TIPO	UN.		PRECIO + IVA
50-13-048	-	4,1/2"	Pza.	-	

TIJERA ESCOLAR FORJADA

Acabado níquel cromo



CODIGO	REF.	MEDIDA/TIPO	UN.		PRECIO + IVA
50-13-070	8346	4.1/2"	Pza.	-	



TIJERA BORDAR CURVA



CODIGO	REF.	MEDIDA/TIPO	UN.		PRECIO + IVA
11-13-187	427-4	4"	Pza.	-	

TIJERA CUTÍCULA



CODIGO	REF.	MEDIDA/TIPO	UN.		PRECIO + IVA
11-15-112	405-314	3,1/4"	Pza.	-	
11-15-110	415-312	3,1/2"	Pza.	-	

HUINCHA AISLADORA VENADO

Embalaje: 500 unidades

Negra

CODIGO	REF.	MEDIDA/TIPO	UN.	MIN.	PRECIO + IVA
05-05-106	-	5 yd x 3/4"	Pza.	10	
05-05-112	-	10 yd x 3/4"	Pza.	10	
05-05-146	-	20 yd x 3/4"	Pza.	10	

Blanca

CODIGO	REF.	MEDIDA/TIPO	UN.	MIN.	PRECIO + IVA
05-05-111	-	5 yd x 3/4"	Pza.	10	
05-05-141	-	10 yd x 3/4"	Pza.	10	
05-05-148	-	20 yd x 3/4"	Pza.	10	

Roja

CODIGO	REF.	MEDIDA/TIPO	UN.	MIN.	PRECIO + IVA
05-05-107	-	5 yd x 3/4"	Pza.	10	
05-05-118	-	10 yd x 3/4"	Pza.	10	
05-05-150	-	20 yd x 3/4"	Pza.	10	

Amarilla

CODIGO	REF.	MEDIDA/TIPO	UN.	MIN.	PRECIO + IVA
05-05-108	-	5 yd x 3/4"	Pza.	10	
05-05-123	-	10 yd x 3/4"	Pza.	10	
05-05-152	-	20 yd x 3/4"	Pza.	10	

Azul

CODIGO	REF.	MEDIDA/TIPO	UN.	MIN.	PRECIO + IVA
05-05-109	-	5 yd x 3/4"	Pza.	10	
05-05-129	-	10 yd x 3/4"	Pza.	10	
05-05-154	-	20 yd x 3/4"	Pza.	10	

Verde

CODIGO	REF.	MEDIDA/TIPO	UN.	MIN.	PRECIO + IVA
05-05-110	-	5 yd x 3/4"	Pza.	10	
05-05-136	-	10 yd x 3/4"	Pza.	10	
05-05-156	-	20 yd x 3/4"	Pza.	10	



CLAVOS CORRIENTES

Acero al carbono

Para construcción en general



CODIGO	REF.	MEDIDA/TIPO	UN.		PRECIO + IVA
--------	------	-------------	-----	--	--------------

Caja 10 Kg

12-03-001	-	1/2"	Caja	-	
12-03-005	-	3/4"	Caja	-	
12-03-010	-	1"	Caja	-	

Caja 25 Kg

12-03-015	-	1.1/4"	Caja	-	
12-03-020	-	1.1/2"	Caja	-	
12-03-025	-	1.3/4"	Caja	-	
12-03-030	-	2"	Caja	-	
12-03-035	-	2.1/2"	Caja	-	
12-03-040	-	3"	Caja	-	
12-03-045	-	3.1/2"	Caja	-	
12-03-050	-	4"	Caja	-	
12-03-055	-	5"	Caja	-	
12-03-060	-	6"	Caja	-	

CLAVOS PUNTA

Acero al carbono

Para acabados de tapicería, mueblería y terminaciones



CODIGO	REF.	MEDIDA/TIPO	UN.		PRECIO + IVA
--------	------	-------------	-----	--	--------------

Caja 10 Kg

12-03-110	-	1" - 10 kg	Caja	-	
-----------	---	------------	------	---	--

CLAVOS DE ACERO ESTRIADO VERTICAL

Aluminizado



CODIGO	REF.	MEDIDA/TIPO	UN.	PRECIO + IVA
--------	------	-------------	-----	--------------

Venta solo en cajas de 2,5 cientos

57-03-198	-	2,7 x 20	Cien	125
57-03-200	-	2,7 x 25	Cien	125
57-03-205	-	2,7 x 30	Cien	125
57-03-210	-	2,7 x 35	Cien	125
57-03-215	-	2,7 x 40	Cien	125
57-03-220	-	2,7 x 50	Cien	125
57-03-230	-	3,5 x 40	Cien	125
57-03-235	-	3,5 x 45	Cien	40
57-03-240	-	3,5 x 55	Cien	40
57-03-245	-	3,5 x 65	Cien	40
57-03-250	-	3,5 x 75	Cien	40
57-03-260	-	3,5 x 90	Cien	40

TACHUELA TAPICERO



CODIGO	REF.	MEDIDA/TIPO	UN.	PRECIO + IVA
--------	------	-------------	-----	--------------

57-02-010	-	1/2"	Caja 450 g	50
57-02-013	-	5/8"	Caja 450 g	50
57-02-015	-	3/4"	Caja 450 g	50
57-02-025	-	1/2"	Caja 50 g	450
57-02-028	-	5/8"	Caja 50 g	450
57-02-030	-	3/4"	Caja 50 g	450

CLAVOS DE ACERO LISOS

Azul metálico



CODIGO	REF.	MEDIDA/TIPO	UN.	PRECIO + IVA
--------	------	-------------	-----	--------------

Venta solo en cajas de 5 cientos

57-03-100	-	2,0 x 15	Cien	250
57-03-105	-	2,0 x 20	Cien	250
57-03-110	-	2,0 x 25	Cien	250
57-03-115	-	2,0 x 30	Cien	250
57-03-120	-	2,0 x 40	Cien	250
57-03-125	-	2,0 x 50	Cien	80
57-03-130	-	2,5 x 30	Cien	80
57-03-135	-	2,5 x 40	Cien	80
57-03-140	-	2,5 x 50	Cien	80

Venta solo en cajas de 2,5 cientos

57-03-142	-	3,0 x 50	Cien	125
57-03-145	-	3,5 x 50	Cien	40
57-03-150	-	3,5 x 60	Cien	40
57-03-155	-	3,5 x 70	Cien	40
57-03-160	-	3,5 x 80	Cien	30
57-03-165	-	3,5 x 90	Cien	30
57-03-174	-	4,3 x 100	Cien	30

CLAVO DE HERRAR “TORNADO”

Para caballos de trabajo, tiro pesado, adiestramiento y equitación

Su cabeza se ajusta a las claveras de las herraduras de estos equinos.

Su ajuste perfecto permite mayor duración del herraje y evita el cizallamiento de la cabeza del clavo.

La punta fina con guía precisa, facilita la entrada y el manejo en el momento del clavado y remachado



CODIGO	REF.	MEDIDA/TIPO	UN.		PRECIO + IVA
57-37-003	E-3	45 mm	Caja 100 un.	36	

CLAVO PARA GUARDAPOLVO

Clavo de acero liso azul, sin cabeza

Especial para fijar guarda polvos y pisos de madera



CODIGO	REF.	MEDIDA/TIPO	UN.		PRECIO + IVA
57-03-290	-	1.1/2"	Caja 500 g	50	

ARANDELA DE PRESIÓN GALVANIZADA

Norma: DIN 127 - Material: acero SAE - 1070 Dureza HRC 45-52



CODIGO	REF.	MEDIDA/TIPO	UN.		PRECIO + IVA
57-01-009	-	1/4"	Bolsa 100 un.	-	
57-01-011	-	5/16"	Bolsa 100 un.	-	
57-01-013	-	3/8"	Bolsa 100 un.	-	
57-01-015	-	7/16"	Bolsa 100 un.	-	
57-01-017	-	1/2"	Bolsa 100 un.	-	

GRAPAS PLÁSTICAS

Para sostener cables eléctricos redondos o paralelo plástico

Los empaques contienen la grapa y el clavo de acero especial liso galvanizado



Cuadrada blanca

CODIGO	REF.	MEDIDA/TIPO	UN.		PRECIO + IVA
57-05-010	-	2 x 22	Bolsa 50 un.	100	
57-05-013	-	2 x 24	Bolsa 50 un.	100	



Redonda blanca

CODIGO	REF.	MEDIDA/TIPO	UN.		PRECIO + IVA
57-05-016	-	9 mm Grande	Bolsa 50 un.	100	
57-05-019	-	6 mm Mediana	Bolsa 50 un.	100	
57-05-021	-	4 mm Pequeña	Bolsa 50 un.	100	



Redonda negra

CODIGO	REF.	MEDIDA/TIPO	UN.		PRECIO + IVA
57-05-040	-	9 mm Grande	Bolsa 50 un.	100	
57-05-043	-	6 mm Mediana	Bolsa 50 un.	100	

GRAPA GALVANIZADA PARA CERCA

Ideales para trabajar sobre estacones y cercas con alambre de púas



CODIGO	REF.	MEDIDA/TIPO	UN.		PRECIO + IVA
57-03-400	-	1"	Caja 490 g	-	
57-03-402	-	3/4"	Caja 490 g	-	

ENGRAPADORA LT-207



CODIGO	REF.	MEDIDA/TIPO	UN.		PRECIO + IVA
06-08-216	LT-207	-	Pza.	12	

Grapas para LT-207

06-08-221	-	1/4" - 6 mm	Mil	-	
06-08-226	-	5/16" - 8 mm	Mil	-	

ENGRAPADORA PROFESIONAL LT-1

Con implemento distanciador para engrapado de cables eléctricos, que permite fijar los cables sin dañarlos.



CODIGO	REF.	MEDIDA/TIPO	UN.		PRECIO + IVA
06-08-180	LT-1	-	Pza.	6	

Grapas para LT-1

06-08-185	-	5/16" - 8 mm	Mil	-	
06-08-190	-	3/8" - 10 mm	Mil	-	
06-08-195	-	1/2" - 12 mm	Mil	-	
06-08-200	-	9/16" - 14 mm	Mil	-	

ENGRAPADORA PROFESIONAL TIPO MARTILLO

Fácil manejo con una mano

- Cuerpo metálico con diseño robusto y resistente para mayor durabilidad.
- Ideal para el engrapado de alfombras, papel fieltro, teja asfáltica, laminas plásticas y cualquier material aislante.
- Mango recubierto de goma que absorbe el golpe y protege la mano.



CODIGO	REF.	MEDIDA/TIPO	UN.		PRECIO + IVA
06-08-245	G-10550	12"	Pza.	10	

Grapas para G-10550, Caja 5000 unidades

06-08-249	-	5/16" - 8mm	Cja.	-	
-----------	---	-------------	------	---	--

ENGRAPADORA PROFESIONAL TIPO ALICATE

Uso industrial

- Cuerpo completamente metálico Ligero y resistente.
- Útil para el engrapado de papel, cartón, micas, bolsas plásticas.
- Con tres tipos de soporte receptor para una mejor adaptación al material a engraparse.



CODIGO	REF.	MEDIDA/TIPO	UN.		PRECIO + IVA
06-08-260	HSP-12	-	Pza.	10	

REMACHES ALUMINIO

Caja 1000 unidades



CODIGO	MEDIDA/TIPO	UN.		MIN	PRECIO + IVA
41-08-101	3 x 6 mm	Mil	10	-	
41-08-103	3 x 8 mm	Mil	20	-	
41-08-105	3 x 10 mm	Mil	20	-	
41-08-107	3 x 12 mm	Mil	20	-	
41-08-109	3 x 14 mm	Mil	20	-	
41-08-111	3 x 16 mm	Mil	20	-	
41-08-113	3 x 18 mm	Mil	20	-	
41-08-117	4 x 6 mm	Mil	20	-	
41-08-119	4 x 8 mm	Mil	20	-	
41-08-121	4 x 10 mm	Mil	20	-	
41-08-123	4 x 12 mm	Mil	20	-	
41-08-125	4 x 14 mm	Mil	20	-	
Caja 500 u					
41-08-127	4 x 16 mm	Mil	20	-	
41-08-129	4 x 19 mm	Mil	20	-	
41-08-131	4 x 22 mm	Mil	20	-	
41-08-133	5 x 8 mm	Mil	20	-	
41-08-135	5 x 10 mm	Mil	20	-	
41-08-137	5 x 12 mm	Mil	20	-	
41-08-139	5 x 14 mm	Mil	20	-	
41-08-141	5 x 16 mm	Mil	20	-	
41-08-142	5 x 18 mm	Mil	20	-	
41-08-144	5 x 20 mm	Mil	10	-	
41-08-145	5 x 22 mm	Mil	10	-	
41-08-147	5 x 25 mm	Mil	20	-	
41-08-149	5 x 30 mm	Mil	20	-	

Bolsa 100 unidades



CODIGO	MEDIDA/TIPO	UN.		MIN	PRECIO + IVA
90-08-100	3 x 6 mm	Cien	-	-	
90-08-103	3 x 8 mm	Cien	-	-	
90-08-106	3 x 10 mm	Cien	-	-	
90-08-109	3 x 12 mm	Cien	-	-	
90-08-110	3 x 14 mm	Cien	-	-	
90-08-115	3 x 16 mm	Cien	-	-	
90-08-118	3 x 18 mm	Cien	-	-	
90-08-124	4 x 6 mm	Cien	-	-	
90-08-127	4 x 8 mm	Cien	-	-	
90-08-130	4 x 10 mm	Cien	-	-	
90-08-133	4 x 12 mm	Cien	-	-	
90-08-134	4 x 14 mm	Cien	-	-	
90-08-139	4 x 16 mm	Cien	-	-	
90-08-142	4 x 19 mm	Cien	-	-	
90-08-144	4 x 22 mm	Cien	-	-	
90-08-148	5 x 8 mm	Cien	-	-	
90-08-151	5 x 10 mm	Cien	-	-	
90-08-154	5 x 12 mm	Cien	-	-	
90-08-155	5 x 14 mm	Cien	-	-	
90-08-157	5 x 16 mm	Cien	-	-	
90-08-158	5 x 18 mm	Cien	-	-	
90-08-164	5 x 20 mm	Cien	-	-	
90-08-166	5 x 22 mm	Cien	-	-	
90-08-169	5 x 25 mm	Cien	-	-	
90-08-172	5 x 30 mm	Cien	-	-	

TARUGOS CLAVO (DE GOLPE)

Fácil y simple de instalar. Clavo cabeza "Phillips" atornillable

Para instalación de marcos de puertas y ventanas, maderas en general; todas estas a superficies de concreto y ladrillo.



CODIGO	REF.	MEDIDA/TIPO	UN.		PRECIO + IVA
53-08-022	-	6 x 40	Cien	60	
53-08-025	-	6 x 50	Cien	40	
53-08-028	-	6 x 60	Cien	40	
53-08-034	-	6 x 80	Cien	25	
53-08-043	-	8 x 60	Cien	20	
53-08-046	-	8 x 80	Cien	20	
53-08-049	-	8 x 100	Cien	20	
53-08-052	-	8 x 120	Cien	16	
53-08-058	-	8 x 140	Cien	12	

TARUGOS "VOLCANITA" UNIVERSAL

En bolsas



CODIGO	REF.	MEDIDA/TIPO	UN.		PRECIO + IVA
53-08-170	-	6 mm	Bolsa 100	-	
53-08-172	-	8 mm	Bolsa 100	-	

TARUGOS TIPO "FISCHER"

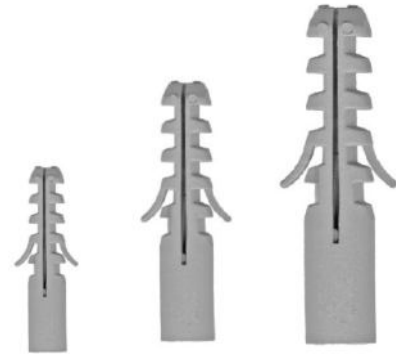

CODIGO	REF.	MEDIDA/TIPO	UN.		PRECIO + IVA
--------	------	-------------	-----	--	--------------

Bolsa 1000 unidades

53-08-132	-	5 mm	Mil	35	
53-08-134	-	6 mm	Mil	25	
53-08-136	-	8 mm	Mil	10	
53-08-138	-	10 mm	Mil	5	
53-08-140	-	12 mm	Mil	3	

Bolsa 100 unidades

90-08-005	-	5 mm	Cien	-	
90-08-006	-	6 mm	Cien	-	
90-08-008	-	8 mm	Cien	-	
90-08-010	-	10 mm	Cien	-	
90-08-012	-	12 mm	Cien	-	

TARUGOS "VOLCANITA" ATORNILLABLE

En bolsas



CODIGO	REF.	MEDIDA/TIPO	UN.		PRECIO + IVA
53-08-160	-	15 mm	Cien	80	

TARUGOS VOLCANITA “PALOMA”

En bolsas



CODIGO	REF.	MEDIDA/TIPO	UN.		PRECIO + IVA
53-08-150	-	10 mm	Cien	30	

TARUGOS “INTERNIT”

En bolsas



CODIGO	REF.	MEDIDA/TIPO	UN.		PRECIO + IVA
53-08-180	-	3,2 - 6 mm	Cien	120	

TARUGOS “VOLCANITA”

En bolsas



CODIGO	REF.	MEDIDA/TIPO	UN.		PRECIO + IVA
53-08-183	-	9 - 13 mm	Cien	100	
53-08-186	-	13 - 16 mm	Cien	-	

DISTANCIADOR DE CERÁMICA

En bolsas



CODIGO	REF.	MEDIDA/TIPO	UN.		PRECIO + IVA
53-03-186	-	2 mm	Doscientos	200	
53-03-188	-	3 mm	Doscientos	100	
53-03-190	-	4 mm	Cien	100	
53-03-192	-	5 mm	Cien	100	

TORNILLO ROSCALATA

Cabeza binding, excelente terminación

Ranuras combinada recta-phillips



Bolsa 100 unidades

CODIGO	MEDIDA/TIPO	UN.		MIN.	PRECIO + IVA
59-08-100	#4 x 1/4"	Cien	240	-	
59-08-125	#4 x 3/4"	Cien	240	-	
59-08-127	#6 x 1/4"	Cien	240	-	
59-08-130	#6 x 3/8"	Cien	240	-	
59-08-135	#6 x 1/2"	Cien	240	-	
59-08-140	#6 x 5/8"	Cien	150	-	
59-08-145	#6 x 3/4"	Cien	150	-	
59-08-150	#6 x 1"	Cien	125	-	
59-08-155	#6 x 1, 1/4"	Cien	90	-	
59-08-160	#6 x 1, 1/2"	Cien	70	-	
59-08-165	#8 x 3/8"	Cien	150	-	
59-08-170	#8 x 1/2"	Cien	125	-	
59-08-175	#8 x 5/8"	Cien	125	-	
59-08-180	#8 x 3/4"	Cien	90	-	
59-08-185	#8 x 1"	Cien	90	-	
59-08-190	#8 x 1, 1/4"	Cien	70	-	
59-08-195	#8 x 1, 1/2"	Cien	50	-	
59-08-202	#8 x 2, 1/2"	Cien	36	-	
59-08-205	#10 x 1/2"	Cien	90	-	
59-08-210	#10 x 5/8"	Cien	90	-	
59-08-215	#10 x 3/4"	Cien	70	-	
59-08-217	#10 x 1"	Cien	70	-	
59-08-220	#10 x 1, 1/4"	Cien	50	-	
59-08-225	#10 x 1, 1/2"	Cien	40	-	
59-08-230	#10 x 2"	Cien	36	-	
59-08-240	#12 x 1, 1/4"	Cien	40	-	
59-08-245	#12 x 1, 1/2"	Cien	36	-	
59-08-250	#12 x 2"	Cien	24	-	
59-08-252	#12 x 2, 1/2"	Cien	20	-	
59-08-340	#14 x 1"	Cien	40	-	
59-08-350	#14 x 1, 1/2"	Cien	24	-	
59-08-360	#14 x 2"	Cien	20	-	
59-08-362	#14 x 2, 1/2"	Cien	16	-	

TORNILLO AUTOPERFORANTES

Cabeza plana, zincado

Ranuras tipo phillips



Bolsa 100 unidades

CODIGO	MEDIDA/TIPO	UN.		MIN.	PRECIO + IVA
59-08-380	#6 x 1"	cien	-	-	
59-08-382	#6 x 1.1/4"	cien	40	-	
59-08-384	#6 x 1.5/8"	cien	30	-	
59-08-386	#6 x 2"	cien	25	-	

Cabeza truss, zincado

Ranuras tipo phillips



Bolsa 100 unidades

CODIGO	MEDIDA/TIPO	UN.		MIN.	PRECIO + IVA
59-08-413	#8 x 1/2"	Cien	125	-	
59-08-415	#8 x 3/4"	Cien	125	-	
59-08-417	#8 x 1"	Cien	70	-	
59-08-419	#8 x 1.1/4"	Cien	50	-	

Punta fina

59-08-420	#8 x 3/4"	Cien	-	-	
-----------	-----------	------	---	---	--

Cabeza hexagonal, con golilla

Hexagonal



Bolsa 100 unidades

CODIGO	MEDIDA/TIPO	UN.		MIN.	PRECIO + IVA
59-08-800	#10 x 3/4"	Cien	40	-	
59-08-802	#10 x 1"	Cien	30	-	
59-08-804	#12 x 3/4"	Cien	24	-	
59-08-806	#12 x 1"	Cien	30	-	
59-08-808	#12 x 1.1/4"	Cien	20	-	
59-08-810	#12 x 2"	Cien	16	-	
59-08-812	#12 x 3"	Cien	10	-	
59-08-814	#12 x 4"	Cien	6	-	

TORNILLOS VOLCANITA, cabeza plana, punta fina

Negro hilo grueso

+ Ranuras tipo phillips



Bolsa 100 unidades

CODIGO	MEDIDA/TIPO	UN.		MIN.	PRECIO + IVA
59-08-502	#6 x 3/4"	Cien	180	-	
59-08-505	#6 x 1"	Cien	120	-	
59-08-508	#6 x 1,1/4"	Cien	100	-	
59-08-510	#6 x 1,1/2"	Cien	100	-	
59-08-512	#6 x 1,5/8"	Cien	80	-	
59-08-516	#6 x 2"	Cien	70	-	
59-08-518	#6 x 2,1/4"	Cien	60	-	
59-08-546	#8 x 2"	Cien	24	-	
59-08-548	#8 x 2,1/2"	Cien	50	-	
59-08-550	#8 x 3"	Cien	50	-	

Negro hilo fino

+ Ranuras tipo phillips



Bolsa 100 unidades

CODIGO	MEDIDA/TIPO	UN.		MIN.	PRECIO + IVA
59-08-700	#6 x 1"	Cien	72	-	
59-08-702	#6 x 1,1/4"	Cien	80	-	
59-08-704	#6 x 1,1/2"	Cien	48	-	
59-08-706	#6 x 1,5/8"	Cien	60	-	
59-08-708	#6 x 2"	Cien	-	-	

Zincado hilo grueso

+ Ranuras tipo phillips



Bolsa 100 unidades

CODIGO	MEDIDA/TIPO	UN.		MIN.	PRECIO + IVA
59-08-570	#6 x 3/4"	Cien	72	-	
59-08-572	#6 x 1"	Cien	120	-	
59-08-574	#6 x 1,1/4"	Cien	100	-	
59-08-576	#6 x 1,1/2"	Cien	100	-	
59-08-578	#6 x 1,5/8"	Cien	80	-	
59-08-580	#6 x 2"	Cien	70	-	
59-08-582	#6 x 2,1/4"	Cien	-	-	

Zincado hilo fino

+ Ranuras tipo phillips



Bolsa 100 unidades

CODIGO	MEDIDA/TIPO	UN.		MIN.	PRECIO + IVA
59-08-730	#6 x 1"	Cien	110	-	
59-08-732	#6 x 1,1/4"	Cien	80	-	
59-08-734	#6 x 1,1/2"	Cien	-	-	
59-08-736	#6 x 1,5/8"	Cien	60	-	
59-08-738	#6 x 2"	Cien	24	-	

TORNILLO BRONCEADO PARA MADERA

Acabado zincado dicromatado



Bolsas 100 un /
144 un (gruesa) según medida

CODIGO MEDIDA/TIPO UN. MIN. PRECIO + IVA

+ Ranuras tipo phillips

CODIGO	MEDIDA/TIPO	UN.	MIN.	PRECIO + IVA
59-02-640	#4 x 1/2"	Cien	300	-
59-02-643	#4 x 5/8"	Gruesa	-	-
59-02-652	#5 x 5/8"	Cien	200	-
59-02-654	#5 x 3/4"	Cien	200	-
59-02-656	#5 x 1"	Gruesa	-	-
59-02-658	#5 x 1.1/4"	Gruesa	-	-
59-02-668	#6 x 3/4"	Cien	200	-
59-02-671	#6 x 1"	Gruesa	-	-
59-02-673	#6 x 1.1/4 "	Gruesa	-	-
59-02-680	#7 x 3/4"	Cien	150	-
59-02-682	#7 x 1"	Cien	100	-
59-02-696	#8 x 1"	Cien	100	-
59-02-700	#9 x 3/4"	Gruesa	-	-
59-02-720	#9 x 2"	Gruesa	-	-
59-02-760	#12 x 3"	Cien	20	-
59-02-764	#12 x 3.1/2"	Cien	20	-

● Ranura recta

CODIGO	MEDIDA/TIPO	UN.	MIN.	PRECIO + IVA
59-02-621	#3 x 3/8"	Gruesa	-	-
59-02-657	#5 x 1"	Gruesa	-	-
59-02-681	#7 x 3/4"	Gruesa	-	-
59-02-661	#12 x 3"	Gruesa	-	-
59-02-666	#12 x 3.1/2"	Gruesa	-	-

TORNILLOS PARA TECHO ZINCADO

Con golilla de PCV

● Ranura recta



Bolsa 144 unidades

CODIGO MEDIDA/TIPO UN. MIN. PRECIO + IVA

CODIGO	MEDIDA/TIPO	UN.	MIN.	PRECIO + IVA
59-08-450	5 mm x 2"	Gruesa	25	-
59-08-454	5 mm x 3"	Gruesa	20	-

TORNILLOS PARA MADERA TIPO SPAX

Acabado zincado amarillo

+ Ranuras tipo pozidriv



Bolsa 100 unidades

CODIGO MEDIDA/TIPO UN. MIN. PRECIO + IVA

CODIGO	MEDIDA/TIPO	UN.	MIN.	PRECIO + IVA
59-02-040	3 x 20 mm	Cien	200	-
59-02-050	3 x 30 mm	Cien	120	-
59-02-053	3.5 x 12 mm	Cien	72	-
59-02-055	3.5 x 13 mm	Cien	200	-
59-02-060	3.5 x 16 mm	Cien	200	-
59-02-062	3.5 x 20 mm	Cien	160	-
59-02-065	3.5 x 25 mm	Cien	120	-
59-02-068	3.5 x 30 mm	Cien	-	-
59-02-069	3.5 x 35 mm	Cien	130	-
59-02-070	3.5 x 40 mm	Cien	80	-
59-02-073	4 x 20 mm	Cien	-	-
59-02-076	4 x 30 mm	Cien	72	-
59-02-078	4 x 35 mm	Cien	-	-
59-02-080	4 x 40 mm	Cien	48	-
59-02-085	4 x 45 mm	Cien	80	-
59-02-093	4.5 x 35 mm	Cien	-	-
59-02-095	4.5 x 40 mm	Cien	-	-
59-02-100	4.5 x 45 mm	Cien	-	-
59-02-105	4.5 x 50 mm	Cien	50	-
59-02-110	4.5 x 60 mm	Cien	40	-
59-02-120	5 x 40 mm	Cien	-	-
59-02-130	5 x 50 mm	Cien	-	-
59-02-140	5 x 60 mm	Cien	-	-
59-02-142	5 x 70 mm	Cien	40	-

TORNILLO SOBERBIO

Acabado zincado, cabeza plana

+ Ranuras tipo pozidriv



Bolsa 100 unidades

CODIGO MEDIDA/TIPO UN. MIN. PRECIO + IVA

CODIGO	MEDIDA/TIPO	UN.	MIN.	PRECIO + IVA
59-02-198	5 x 40 mm	Cien	40	-
59-02-200	5 x 50 mm	Cien	36	-



NUEVA LÍNEA DE FITTING PPR

El Polipropileno Random (PPR) es un polímero termoplástico de propileno de alta tecnología del cual se fabrican tuberías y conexiones. Entre sus propiedades mecánicas se destacan sus valores de rigidez, dureza y resistencia. Este tipo de material es usado comúnmente para agua potable fría/caliente y sistemas de calefacción, siendo una de las principales ventajas su fácil y rápida instalación.



PRINCIPALES CARACTERÍSTICAS

- Cero fugas.
- Alta tolerancia de presión.
- Ausencia de corrosión.
- Aislamiento térmico.
- Larga vida.
- Peso liviano.
- Tecnología rápida y cómoda de fusión.
- Ausencia de incrustaciones.
- Menor pérdida de carga.
- Idóneo para zonas de peligro sísmico.
- 100% higiénico

 Empaque original (un.)
MIN Mínimo de venta (un.)

MÁQUINA TERMOFUSORA

Con regulación electrónica de temperatura

Soldadora manual con regulador de temperatura digital para la fusión de tubos y accesorios PPR a través del uso de matrices. Equipada de un plato calentador en aluminio con una práctica empuñadura plástica aislada térmicamente.

Características técnicas:

- Voltaje: 220/230 V - 50 Hz
- Potencia: 800 W



Equipamiento

- Adaptadores de: Ø 20, 25, 32, 40, 50 y 63 mm
- Visor digital de temperatura.
- Cubierta con aislamiento térmico.
- Placa de calentamiento.
- Soporte de apoyo adicional.
- Resistente maletín de transporte 100% metálico.



CODIGO	MEDIDA/TIPO	UN.		MIN	PRECIO + IVA
19-06-500	800 W	Pza.	5	-	

LLAVES DE BOLA

Llave bola



CODIGO	MEDIDA/TIPO	UN.		MIN	PRECIO + IVA
19-06-270	20 mm	Pza.	25	-	
19-06-271	25 mm	Pza.	18	-	
19-06-272	32 mm	Pza.	11	-	

Llave paso bola metálica



CODIGO	MEDIDA/TIPO	UN.		MIN	PRECIO + IVA
19-06-280	20 mm	Pza.	12	-	
19-06-281	25 mm	Pza.	8	-	
19-06-282	32 mm	Pza.	6	-	

TERMINALES HILO METÁLICO

Terminal HI



CODIGO	MEDIDA/TIPO	UN.		MIN	PRECIO + IVA
19-06-171	20 mm x 1/2"	Pza.	40	10	
19-06-172	20 mm x 3/4"	Pza.	25	10	
19-06-173	25 mm x 1/2"	Pza.	30	10	
19-06-174	25 mm x 3/4"	Pza.	28	10	
19-06-175	32 mm x 1/2"	Pza.	22	10	
19-06-176	32 mm x 3/4"	Pza.	20	5	
19-06-177	32 mm x 1"	Pza.	16	5	

Terminal HE



CODIGO	MEDIDA/TIPO	UN.		MIN	PRECIO + IVA
19-06-191	20 mm x 1/2"	Pza.	30	10	
19-06-192	20 mm x 3/4"	Pza.	24	10	
19-06-193	25 mm x 1/2"	Pza.	30	10	
19-06-194	25 mm x 3/4"	Pza.	22	10	
19-06-195	32 mm x 1/2"	Pza.	20	10	
19-06-196	32 mm x 3/4"	Pza.	20	10	
19-06-197	32 mm x 1"	Pza.	10	5	

Codo Terminal HI



CODIGO	MEDIDA/TIPO	UN.		MIN	PRECIO + IVA
19-06-210	20 mm x 1/2"	Pza.	30	10	
19-06-211	20 mm x 3/4"	Pza.	24	10	
19-06-212	25 mm x 1/2"	Pza.	24	10	
19-06-213	25 mm x 3/4"	Pza.	20	10	
19-06-214	32 mm x 1/2"	Pza.	15	10	
19-06-215	32 mm x 3/4"	Pza.	12	10	
19-06-216	32 mm x 1"	Pza.	10	5	

Codo Terminal HE



CODIGO	MEDIDA/TIPO	UN.		MIN	PRECIO + IVA
19-06-220	20 mm x 1/2"	Pza.	25	10	
19-06-221	20 mm x 3/4"	Pza.	20	10	
19-06-222	25 mm x 1/2"	Pza.	20	10	
19-06-223	25 mm x 3/4"	Pza.	15	10	
19-06-224	32 mm x 1/2"	Pza.	15	10	
19-06-225	32 mm x 3/4"	Pza.	12	10	
19-06-226	32 mm x 1"	Pza.	9	5	

PUENTES

Puente Corto



CODIGO	MEDIDA/TIPO	UN.		MIN	PRECIO + IVA
19-06-250	20 mm	Pza.	36	10	
19-06-251	25 mm	Pza.	30	10	
19-06-252	32 mm	Pza.	15	10	

Puente Largo



CODIGO	MEDIDA/TIPO	UN.		MIN	PRECIO + IVA
19-06-260	20 mm	Pza.	20	10	
19-06-261	25 mm	Pza.	16	10	
19-06-262	32 mm	Pza.	10	10	

ADAPTADORES

Copla



CODIGO	MEDIDA/TIPO	UN.		MIN	PRECIO + IVA
19-06-001	20 mm	Pza.	150	50	
19-06-002	25 mm	Pza.	90	30	
19-06-003	32 mm	Pza.	50	20	

Tee



CODIGO	MEDIDA/TIPO	UN.		MIN	PRECIO + IVA
19-06-100	20 mm	Pza.	75	30	
19-06-101	25 mm	Pza.	40	20	
19-06-102	32 mm	Pza.	24	10	

Reducción



CODIGO	MEDIDA/TIPO	UN.		MIN	PRECIO + IVA
19-06-012	25 x 20 mm	Pza.	100	50	
19-06-013	32 x 20 mm	Pza.	72	30	
19-06-014	32 x 25 mm	Pza.	60	20	

Tee Reducción



CODIGO	MEDIDA/TIPO	UN.		MIN	PRECIO + IVA
19-06-110	25 x 20 x 25 mm	Pza.	50	20	
19-06-111	32 x 20 x 32 mm	Pza.	30	10	
19-06-112	32 x 25 x 32 mm	Pza.	30	10	

Codo



CODIGO	MEDIDA/TIPO	UN.		MIN	PRECIO + IVA
19-06-050	20 mm	Pza.	100	50	
19-06-051	25 mm	Pza.	60	30	
19-06-052	32 mm	Pza.	30	10	

Cruz



CODIGO	MEDIDA/TIPO	UN.		MIN	PRECIO + IVA
19-06-150	20 mm	Pza.	50	20	
19-06-151	25 mm	Pza.	30	10	
19-06-152	32 mm	Pza.	16	10	

Codo 45°



CODIGO	MEDIDA/TIPO	UN.		MIN	PRECIO + IVA
19-06-070	20 mm	Pza.	120	60	
19-06-071	25 mm	Pza.	70	30	
19-06-072	32 mm	Pza.	40	10	

Tapa gorro



CODIGO	MEDIDA/TIPO	UN.		MIN	PRECIO + IVA
19-06-160	20 mm	Pza.	260	100	
19-06-161	25 mm	Pza.	150	50	
19-06-162	32 mm	Pza.	90	30	

FITTING PVC

Codo soldar



CODIGO	MEDIDA/TIPO	UN.		MIN	PRECIO + IVA
25-06-001	20 mm	Pza.	400	100	
25-06-002	25 mm	Pza.	240	60	
25-06-003	32 mm	Pza.	120	30	
25-06-004	40 mm	Pza.	126	21	
25-06-005	50 mm	Pza.	90	9	
25-06-006	63 mm	Pza.	36	6	

Codo HI - HI



CODIGO	MEDIDA/TIPO	UN.		MIN	PRECIO + IVA
25-06-010	1/2"	Pza.	540	45	
25-06-011	3/4"	Pza.	380	38	
25-06-012	1"	Pza.	200	25	
25-06-013	1.1/4"	Pza.	160	16	
25-06-014	1.1/2"	Pza.	144	12	
25-06-015	2"	Pza.	96	6	

Codo reducción soldar



CODIGO	MEDIDA/TIPO	UN.		MIN	PRECIO + IVA
25-06-020	25 x 20 mm	Pza.	320	40	
25-06-021	32 x 25 mm	Pza.	160	20	

Empaque original (un.)

MIN Mínimo de venta (un.)

Codo reducción HI - HI



CODIGO	MEDIDA/TIPO	UN.		MIN	PRECIO + IVA
25-06-030	1/2" x 3/4"	Pza.	240	30	
25-06-031	1" x 3/4"	Pza.	150	15	

Codo terminal soldar - HI



CODIGO	MEDIDA/TIPO	UN.		MIN	PRECIO + IVA
25-06-040	20 mm x 1/2"	Pza.	350	35	
25-06-041	25 mm x 3/4"	Pza.	220	25	
25-06-042	32 mm x 1"	Pza.	120	15	

Codo 45° soldar



CODIGO	MEDIDA/TIPO	UN.		MIN	PRECIO + IVA
25-06-044	20 mm	Pza.	550	50	
25-06-045	25 mm	Pza.	320	40	
25-06-046	32 mm	Pza.	168	20	
25-06-047	40 mm	Pza.	80	20	
25-06-048	50 mm	Pza.	48	8	
25-06-049	63 mm	Pza.	90	-	

Tee soldar - HI



CODIGO	MEDIDA/TIPO	UN.		MIN	PRECIO + IVA
25-06-050	20 mm x 1/2"	Pza.	250	25	
25-06-051	25 mm x 1/2"	Pza.	180	15	
25-06-052	25 mm x 3/4"	Pza.	162	10	
25-06-053	32 mm 1/2"	Pza.	138	10	

Tee soldar



CODIGO	MEDIDA/TIPO	UN.		MIN	PRECIO + IVA
25-06-060	20 mm	Pza.	260	30	
25-06-061	25 mm	Pza.	160	20	
25-06-062	32 mm	Pza.	168	10	
25-06-063	40 mm	Pza.	108	5	
25-06-064	50 mm	Pza.	60	5	
25-06-065	63 mm	Pza.	32	5	

Tee HI - HI



CODIGO	MEDIDA/TIPO	UN.		MIN	PRECIO + IVA
25-06-070	1/2"	Pza.	375	25	
25-06-071	3/4"	Pza.	240	15	
25-06-072	1"	Pza.	100	10	
25-06-073	1.1/4"	Pza.	120	5	
25-06-074	1.1/2"	Pza.	96	5	
25-06-075	2"	Pza.	54	5	

Tee reducción soldar



CODIGO	MEDIDA/TIPO	UN.		MIN	PRECIO + IVA
25-06-080	25 x 20 mm	Pza.	180	20	
25-06-081	32 x 25 mm	Pza.	168	10	
25-06-082	40 x 32 mm	Pza.	126	5	
25-06-083	50 x 32 mm	Pza.	60	5	

Copla reducción HI - HI



CODIGO	MEDIDA/TIPO	UN.		MIN	PRECIO + IVA
25-06-110	3/4" x 1/2"	Pza.	525	50	
25-06-111	1" x 3/4"	Pza.	330	15	

Buje reducción



CODIGO	MEDIDA/TIPO	UN.		MIN	PRECIO + IVA
25-06-175	3/4" x 1/2"	Pza.	1240	62	
25-06-177	1" x 3/4"	Pza.	600	30	

Buje reducción corto soldar

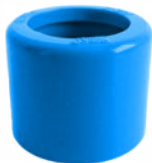

CODIGO	MEDIDA/TIPO	UN.		MIN	PRECIO + IVA
25-06-090	25 x 20 mm	Pza.	1200	100	
25-06-091	32 x 25 mm	Pza.	600	50	
25-06-092	40 x 32 mm	Pza.	340	34	
25-06-093	50 x 40 mm	Pza.	336	12	

Copla soldar



CODIGO	MEDIDA/TIPO	UN.		MIN	PRECIO + IVA
25-06-120	20 mm	Pza.	600	50	
25-06-121	25 mm	Pza.	350	35	
25-06-122	32 mm	Pza.	320	16	
25-06-123	40 mm	Pza.	224	16	
25-06-124	50 mm	Pza.	132	12	
25-06-125	63 mm	Pza.	60	6	

Terminal soldar - HE



CODIGO	MEDIDA/TIPO	UN.		MIN	PRECIO + IVA
25-06-130	20 mm x 1/2"	Pza.	700	140	
25-06-131	25 mm x 3/4"	Pza.	400	100	
25-06-132	32 mm x 1"	Pza.	220	25	
25-06-133	40 mm x 1.1/4"	Pza.	168	10	
25-06-134	50 mm x 1.1/2"	Pza.	165	10	
25-06-135	63 mm x 2"	Pza.	100	5	

Copla reducción soldar



CODIGO	MEDIDA/TIPO	UN.		MIN	PRECIO + IVA
25-06-100	25 x 20 mm	Pza.	350	35	
25-06-101	32 x 25 mm	Pza.	200	25	
25-06-102	40 x 32 mm	Pza.	180	20	

Copla HI - HI



CODIGO	MEDIDA/TIPO	UN.		MIN	PRECIO + IVA
25-06-150	1/2"	Pza.	720	40	
25-06-151	3/4"	Pza.	500	25	
25-06-152	1"	Pza.	350	15	
25-06-153	1.1/4"	Pza.	245	10	
25-06-154	1.1/2"	Pza.	240	6	
25-06-155	2"	Pza.	144	6	

Terminal soldar - HI



CODIGO	MEDIDA/TIPO	UN.		MIN	PRECIO + IVA
25-06-140	20 mm x 1/2"	Pza.	500	50	
25-06-141	25 mm x 3/4"	Pza.	300	60	
25-06-142	32 mm x 1"	Pza.	240	24	
25-06-143	40 mm x 1.1/4"	Pza.	175	10	
25-06-144	50 mm x 1.1/2"	Pza.	125	10	
25-06-145	63 mm x 2"	Pza.	128	8	

Niple HE- HE



CODIGO	MEDIDA/TIPO	UN.		MIN	PRECIO + IVA
25-06-160	1/2"	Pza.	1250	50	
25-06-161	3/4"	Pza.	760	35	
25-06-162	1"	Pza.	400	25	
25-06-163	1.1/4"	Pza.	320	20	
25-06-164	1.1/2"	Pza.	288	12	
25-06-165	2"	Pza.	144	6	

Tapa gorro HI



CODIGO	MEDIDA/TIPO	UN.		MIN	PRECIO + IVA
25-06-190	1/2"	Pza.	850	50	
25-06-191	3/4"	Pza.	500	50	
25-06-192	1"	Pza.	300	25	
25-06-193	1.1/4"	Pza.	204	15	
25-06-194	1.1/2"	Pza.	168	12	
25-06-195	2"	Pza.	131	5	

Niple reducción corto HE - HE



CODIGO	MEDIDA/TIPO	UN.		MIN	PRECIO + IVA
25-06-170	1/2" x 3/4"	Pza.	500	50	
25-06-171	1" 3/4"	Pza.	250	25	
25-06-172	1.1/4" x 1"	Pza.	180	15	

Tapa tornillo



CODIGO	MEDIDA/TIPO	UN.		MIN	PRECIO + IVA
25-06-196	1/2"	Pza.	1200	120	
25-06-197	3/4"	Pza.	600	60	
25-06-198	1"	Pza.	540	20	
25-06-199	1.1/4"	Pza.	378	20	

Tapa gorro soldar



CODIGO	MEDIDA/TIPO	UN.		MIN	PRECIO + IVA
25-06-180	20 mm	Pza.	1000	100	
25-06-181	25 mm	Pza.	600	100	
25-06-182	32 mm	Pza.	330	30	
25-06-183	40 mm	Pza.	336	30	
25-06-184	50 mm	Pza.	198	-	
25-06-185	63 mm	Pza.	100	-	

UNIÓN AMERICANA Y VÁLVULAS DE BOLA

Unión americana soldar



CODIGO	MEDIDA/TIPO	UN.	MIN	PRECIO + IVA
25-06-200	20 mm	Pza. 288	15	
25-06-201	25 mm	Pza. 240	15	
25-06-202	32 mm	Pza. 123	5	
25-06-203	40 mm	Pza. 72	5	
25-06-204	50 mm	Pza. 45	5	
25-06-205	63 mm	Pza. 24	4	

Unión americana HI - HI



CODIGO	MEDIDA/TIPO	UN.	MIN	PRECIO + IVA
25-06-210	1/2"	Pza. 288	12	
25-06-211	3/4"	Pza. 240	5	
25-06-212	1"	Pza. 123	5	
25-06-213	1.1/4"	Pza. 72	5	
25-06-214	1.1/2"	Pza. 45	5	
25-06-215	2"	Pza. 24	4	

Válvula de bola compacta soldar



CODIGO	MEDIDA/TIPO	UN.	MIN	PRECIO + IVA
25-06-300	20 mm	Pza. 162	10	
25-06-301	25 mm	Pza. 80	5	
25-06-302	32 mm	Pza. 84	5	
25-06-303	40 mm	Pza. 50	5	
25-06-304	50 mm	Pza. 50	5	
25-06-305	63 mm	Pza. 24	-	

Válvula de bola compacta HI - HI



CODIGO	MEDIDA/TIPO	UN.	MIN	PRECIO + IVA
25-06-310	1/2"	Pza. 162	10	
25-06-311	3/4"	Pza. 80	5	
25-06-312	1"	Pza. 84	5	
25-06-313	1.1/4"	Pza. 50	5	
25-06-314	1.1/2"	Pza. 50	5	
25-06-315	2"	Pza. 24	-	

Válvula de bola compacta HE - HE



CODIGO	MEDIDA/TIPO	UN.	MIN	PRECIO + IVA
25-06-320	1/2"	Pza. 192	10	
25-06-321	3/4"	Pza. 168	5	

Válvula de bola

Doble unión americana



CODIGO	MEDIDA/TIPO	UN.	MIN	PRECIO + IVA
25-06-340	20 mm / Soldar	Pza. 120	-	
25-06-372	25 mm / HI	Pza. 84	-	
25-06-342	32 mm / Soldar	Pza. 36	-	
25-06-376	40 mm / HI	Pza. 30	-	
25-06-344	50 mm / Soldar	Pza. 24	-	
25-06-345	63 mm / Soldar	Pza. 12	-	

Válvula de bola

HI + unión americana HI



CODIGO	MEDIDA/TIPO	UN.	MIN	PRECIO + IVA
25-06-360	1/2"	Pza. 168	-	
25-06-361	3/4"	Pza. 105	-	
25-06-362	1"	Pza. 84	-	
25-06-363	1.1/4"	Pza. 30	-	
25-06-364	1.1/2"	Pza. 32	-	
25-06-365	2"	Pza. 12	-	

Salida de estanque



CODIGO	MEDIDA/TIPO	UN.	MIN	PRECIO + IVA
25-06-400	32 x 1"	Pza. 70	10	
25-06-402	40 x 1.1/4"	Pza. 70	5	
25-06-404	50 x 1.1/2"	Pza. 60	5	
25-06-406	63 x 2"	Pza. 48	6	

FITTING PVC SANITARIO

Codo 90°



CODIGO	MEDIDA/TIPO	UN.		MIN	PRECIO + IVA
25-06-500	40 mm	Pza.	144	-	
25-06-501	50 mm	Pza.	330	-	
25-06-502	75 mm	Pza.	90	-	
25-06-503	110 mm	Pza.	36	-	

Codo 90° con inspección



CODIGO	MEDIDA/TIPO	UN.		MIN	PRECIO + IVA
25-06-508	110 mm	Pza.	36	-	

Codo 45°



CODIGO	MEDIDA/TIPO	UN.		MIN	PRECIO + IVA
25-06-510	40 mm	Pza.	192	-	
25-06-511	50 mm	Pza.	324	-	
25-06-512	75 mm	Pza.	144	-	
25-06-513	110 mm	Pza.	80	-	

Vee



CODIGO	MEDIDA/TIPO	UN.		MIN	PRECIO + IVA
25-06-520	40 mm	Pza.	108	-	
25-06-521	50 mm	Pza.	180	-	
25-06-522	75 mm	Pza.	60	-	
25-06-523	110 mm	Pza.	20	-	

Vee reducción



CODIGO	MEDIDA/TIPO	UN.		MIN	PRECIO + IVA
25-06-530	75 x 50 mm	Pza.	75	-	
25-06-531	110 x 40 mm	Pza.	45	-	
25-06-532	110 x 50 mm	Pza.	45	-	
25-06-533	110 x 75 mm	Pza.	20	-	

Tee



CODIGO	MEDIDA/TIPO	UN.		MIN	PRECIO + IVA
25-06-540	40 mm	Pza.	108	-	
25-06-541	50 mm	Pza.	220	-	
25-06-542	75 mm	Pza.	54	-	
25-06-543	110 mm	Pza.	24	-	

Tee reducción



CODIGO	MEDIDA/TIPO	UN.		MIN	PRECIO + IVA
25-06-560	75 x 50 mm	Pza.	144	-	
25-06-561	110 x 50 mm	Pza.	72	-	
25-06-562	110 x 75 mm	Pza.	36	-	

Vee reducción con goma

No requiere pegamento



CODIGO	MEDIDA/TIPO	UN.		MIN	PRECIO + IVA
25-06-535	110 x 40 mm	Pza.	24	-	

Tee reducción con goma

No requiere pegamento



CODIGO	MEDIDA/TIPO	UN.		MIN	PRECIO + IVA
25-06-563	110 x 40 mm	Pza.	-	-	

Copla reducción



CODIGO	MEDIDA/TIPO	UN.		MIN	PRECIO + IVA
25-06-570	75 x 50 mm	Pza.	180	-	
25-06-571	110 x 50 mm	Pza.	140	-	
25-06-572	110 x 75 mm	Pza.	120	-	

Trampa desagüe 45°



CODIGO	MEDIDA/TIPO	UN.		MIN	PRECIO + IVA
25-06-705	50 mm	Pza.	144	-	

Copla



CODIGO	MEDIDA/TIPO	UN.		MIN	PRECIO + IVA
25-06-590	40 mm	Pza.	270	-	
25-06-591	50 mm	Pza.	432	-	
25-06-592	75 mm	Pza.	200	-	
25-06-593	110 mm	Pza.	80	-	

Tapa



CODIGO	MEDIDA/TIPO	UN.		MIN	PRECIO + IVA
25-06-601	50 mm	Pza.	600	-	
25-06-602	75 mm	Pza.	400	-	
25-06-603	110 mm	Pza.	192	-	

PORTAELECTRODOS



CODIGO	REF.	MEDIDA/TIPO	UN.		PRECIO + IVA
45-01-672	-	400 A	Pza.	10	
45-01-674	-	600 A	Pza.	10	

VIDRIO MASCARETA SOLDAR

Tonalidad gris



CODIGO	REF.	MEDIDA/TIPO	UN.		PRECIO + IVA
45-01-678	-	51 x 108 Incoloro	Pza.	150	
45-01-680	-	51 x 108 Grado 10	Pza.	100	
45-01-681	-	51 x 108 Grado 11	Pza.	100	
45-01-682	-	51 x 108 Grado 12	Pza.	100	

ESCUADRA ACERO PARA MECÁNICO



CODIGO	REF.	MEDIDA/TIPO	UN.		PRECIO + IVA
45-01-690	-	250 mm	Pza.	5 un.	
45-01-692	-	300 mm	Pza.	5 un.	

PIE DE METRO



CODIGO	REF.	MEDIDA/TIPO	UN.		PRECIO + IVA
45-01-030	-	6"	Pza.	-	

NÚMEROS DE GOLPE

9 piezas

Misma pieza para números 6 y 9



CODIGO	REF.	MEDIDA/TIPO	UN.		PRECIO + IVA
45-03-420	-	5 mm	Jgo.	-	
45-03-430	-	10 mm	Jgo.	-	

ABECEDARIO DE GOLPE

27 piezas



CODIGO	REF.	MEDIDA/TIPO	UN.		PRECIO + IVA
45-03-520	-	5 mm	Jgo.	-	

JUEGO EXTRACTORES DE PERNOS ACERO

5 piezas

Medidas: 3,6 mm
5,0 mm
6,5 mm
8,8 mm
11 mm

RENNSTEIG



CODIGO	REF.	MEDIDA/TIPO	UN.		PRECIO + IVA
45-01-737	-	Nº1-5	Jgo.	-	

MANDRIL CON ROSCA INTERIOR



CODIGO	REF.	MEDIDA/TIPO	UN.		PRECIO + IVA
45-01-757	-	1,5-13 mm	Pza.	-	

LLAVE ALLEN

Cromo Vanadio, acabado negro



CODIGO	REF.	MEDIDA/TIPO	UN.		PRECIO + IVA
45-01-435	-	1/8"	Pza.	-	

GALGAS DE ESPESOR

20 hojas



CODIGO	REF.	MEDIDA/TIPO	UN.		PRECIO + IVA
45-01-747	-	0.05 - 1.00mm	Pza.	10 un.	

LÁPIZ CARPINTERO BI-COLOR

Diseño hexagonal



CODIGO	REF.	MEDIDA/TIPO	UN.	MIN	PRECIO + IVA
46-02-010	-	Azul / Rojo	Pza.	12	

LÁPIZ CARPINTERO 1 COLOR

Diseño ovalado



CODIGO	REF.	MEDIDA/TIPO	UN.	MIN	PRECIO + IVA
46-02-114	-	Grafito	Pza.	10	

CORTAVIDRIOS "UNIVERSAL"

Tipo Jobo



CODIGO	REF.	MEDIDA/TIPO	UN.		PRECIO + IVA
45-03-199	-	-	Pza.	12	

CORTAVIDRIOS "JOBÓ"

Original



CODIGO	REF.	MEDIDA/TIPO	UN.		PRECIO + IVA
45-03-200	-	-	Pza.	12	

DISCO DIAMANTADO "LISO"

Especialmente para cerámicas, azulejos y demás cortes finos



CODIGO	REF.	MEDIDA/TIPO	UN.	PRECIO + IVA
45-03-135	-	4.1/2"	Pza.	-
45-03-137	-	7"	Pza.	-

DISCO DIAMANTADO "SEGMENTADO"

Para piedra, cemento y ladrillos



CODIGO	REF.	MEDIDA/TIPO	UN.	PRECIO + IVA
45-03-143	-	4.1/2"	Pza.	-
45-03-145	-	7"	Pza.	-
45-03-147	-	9"	Pza.	-

DISCO DIAMANTADO "TURBO"

Para piedra, hormigón, piedra refractaria y granito

Borde "cerrado" permite un corte pulcro y sin aristas



CODIGO	REF.	MEDIDA/TIPO	UN.	PRECIO + IVA
45-03-151	-	4.1/2"	Pza.	-

DISTANCIADOR DE CERÁMICA



CODIGO	REF.	MEDIDA/TIPO	UN.	PRECIO + IVA
45-03-310	-	2 mm	Bolsa 250	-
45-03-312	-	3 mm	Bolsa 250	-
45-03-313	-	4 mm	Bolsa 250	-
45-03-314	-	5 mm	Bolsa 200	-
45-03-316	-	6 mm	Bolsa 200	-

PROBADORES DE CORRIENTE

110 a 500 Volt

Cabeza plástica



CODIGO	REF.	MEDIDA/TIPO	UN.	PRECIO + IVA
45-05-115	-	140 mm	Pza.	12

Cabeza bronce



CODIGO	REF.	MEDIDA/TIPO	UN.	PRECIO + IVA
45-05-125	-	140 mm	Pza.	12 un.

Cabeza atornillada bronce



CODIGO	REF.	MEDIDA/TIPO	UN.	PRECIO + IVA
45-05-120	-	190 mm	Pza.	12 un.

GUÍA NYLON (LAUCHA)

Para tuberías Eléctricas



CODIGO	REF.	MEDIDA/TIPO	UN.		PRECIO + IVA
45-05-152	-	10 m	Pza.	10	
45-05-156	-	15 m	Pza.	10	
45-05-160	-	25 m	Pza.	10	

BALANZA RESORTE

Escala de latón



CODIGO	REF.	MEDIDA/TIPO	UN.		PRECIO + IVA
45-11-150	-	10 kg	Pza.	12	
45-11-155	-	15 kg	Pza.	12	
45-11-160	-	20 kg	Pza.	12	
45-11-165	-	25 kg	Pza.	6	
45-11-170	-	50 kg	Pza.	6	
45-11-175	-	100 kg	Pza.	6	

TIJERA ESQUILAR OVEJAS "BERGER"



CODIGO	REF.	MEDIDA/TIPO	UN.		PRECIO + IVA
45-11-005	-	11"	Pza.	6	
45-11-007	-	12"	Pza.	6	

MOSQUETÓN GALVANIZADO PARA BOMBERO

Capacidad máxima: 350 kg



CODIGO	REF.	MEDIDA/TIPO	UN.		PRECIO + IVA
45-20-020	-	100 x 10 mm	Pza.	25 un.	

CONTADOR MANUAL



CODIGO	REF.	MEDIDA/TIPO	UN.		PRECIO + IVA
45-03-400	-	-	Pza.	-	

HOJA SIERRA ARCO ESCOLAR

Para madera



CODIGO	REF.	MEDIDA/TIPO	UN.		PRECIO + IVA
45-20-015	-	162 mm	Gruesa	-	
90-20-100	-	162 mm	Docena	-	

ALICATE SACABOCADO



CODIGO	REF.	MEDIDA/TIPO	UN.		PRECIO + IVA
45-20-110	-	220 mm	Pza.	-	

CORDÓN COLGAR ROPA

Resistente piola de acero plastificada



CODIGO	REF.	MEDIDA/TIPO	UN.		PRECIO + IVA
90-07-020	-	20 m	rollo	-	
90-07-015	-	500 m	rollo	-	
90-07-010	-	2100 m	rollo	-	

BARRA "T" DESLIZANTE

PRAKTUS®



CODIGO	MEDIDA/TIPO	UN.		MIN	PRECIO + IVA
46-01-210	1/2" x 10"	Pza.	-	-	

BARRA EXTENSORA

PRAKTUS®



CODIGO	MEDIDA/TIPO	UN.		MIN	PRECIO + IVA
46-01-212	1/2" x 5"	Pza.	-	-	

**CHICHARRA
Cromada**

PRAKTUS®



CODIGO	MEDIDA/TIPO	UN.		MIN	PRECIO + IVA
46-01-200	1/2"	Pza.	6	-	

DADO PARA BUJÍAS



CODIGO	MEDIDA/TIPO	UN.		MIN	PRECIO + IVA
46-01-233	1/2" x 21 mm	Pza.	-	-	

DADOS HEXAGONALES CROMADOS



CODIGO	MEDIDA/TIPO	UN.		MIN	PRECIO + IVA
46-01-264	1/2" x 18 mm	Pza.	-	-	
46-01-270	1/2" x 20 mm	Pza.	-	-	
46-01-273	1/2" x 21 mm	Pza.	-	-	
46-01-279	1/2" x 23 mm	Pza.	-	-	
46-01-288	1/2" x 27 mm	Pza.	-	-	

JUEGOS DE LLAVES ALLEN

Goldcraft
German Standard



CODIGO	MEDIDA/TIPO	UN.		MIN	PRECIO + IVA
--------	-------------	-----	--	-----	--------------

En milímetros

46-01-100	8 Pzas (1,5-6mm)	Pza.	50	-	
46-01-102	10 Pzas (1,5-10 mm)	Pza.	25	-	

VIDRIO P. MASCARETA SOLDAR

Tonalidad gris



CODIGO	MEDIDA/TIPO	UN.		MIN	PRECIO + IVA
46-01-150	51 x 108 incoloro	Pza.	160	-	
46-01-152	51 x 108 grado 10	Pza.	100	-	
46-01-153	51 x 108 grado 11	Pza.	100	-	
46-01-154	51 x 108 grado 12	Pza.	100	-	

PINZA TOMATIERRA



CODIGO	MEDIDA/TIPO	UN.		MIN	PRECIO + IVA
46-01-140	300 A	Pza.	-	-	
46-01-144	500 A	Pza.	-	-	

LLAVE CROMADA AJUSTABLE



CODIGO	MEDIDA/TIPO	UN.		MIN	PRECIO + IVA
46-01-070	6"	Pza.	6	-	

ALICATE UNIVERSAL

Mango bicolor

Cabeza pulida, excelente calidad y presentación en display.



CODIGO	MEDIDA/TIPO	UN.		MIN	PRECIO + IVA
46-01-011	8"	Pza.	6	-	

ALICATE CORTANTE

Mango bicolor



CODIGO	MEDIDA/TIPO	UN.		MIN	PRECIO + IVA
46-01-034	6"	Pza.	6	-	

ALICATE PUNTA

Mango bicolor



CODIGO	MEDIDA/TIPO	UN.		MIN	PRECIO + IVA
46-01-039	7"	Pza.	6	-	

CAIMÁN BOCA CURVA

Cromado



CODIGO	MEDIDA/TIPO	UN.		MIN	PRECIO + IVA
46-01-062	10"	Pza.	-	-	

DESTORNILLADORES PARA ELECTRICISTA



CODIGO	MEDIDA/TIPO	UN.		MIN	PRECIO + IVA
46-05-038	3" P. plana	Pza.	12	-	
46-05-040	3" P. cruz	Pza.	12		

JGO. DESTORNILLADORES PARA ELECTRICISTA

2 piezas, punta cruz / punta plana

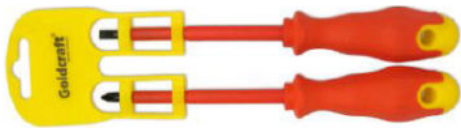

CODIGO	MEDIDA/TIPO	UN.		MIN	PRECIO + IVA
46-05-018	4"	Jgo.	25	-	

JUEGO DESTORNILLADORES

2 piezas, punta cruz / punta plana

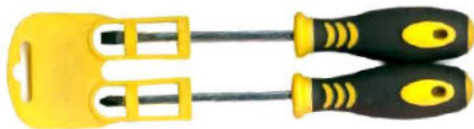

CODIGO	MEDIDA/TIPO	UN.		MIN	PRECIO + IVA
46-02-060	6 mm x 4"	Jgo.	25	-	
46-02-062	6 mm x 6"	Jgo.	25	-	

JUEGO DESTORNILLADORES RELOJERO

6 piezas en caja plástica, puntas planas / cruz

4 Punta plana 1.0mm - 1.4mm - 2.0mm - 2.4mm
2 Punta cruz - N°0 - N°1

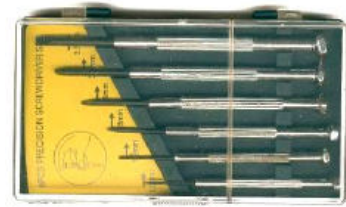

CODIGO	MEDIDA/TIPO	UN.		MIN	PRECIO + IVA
46-20-032	-	Jgo.	50	-	

PINZA

Mordazas adaptables a superficie



CODIGO	MEDIDA/TIPO	UN.		MIN	PRECIO + IVA
46-02-120	4"	Pza.	50	-	
46-02-121	6"	Pza.	50	-	

PRENSA DE ACCIÓN RÁPIDA

Plástico de alto impacto con barra metálica

Cabeza volteable para uso como espaciadora
Botón de liberación instantánea



CODIGO	MEDIDA/TIPO	UN.		MIN	PRECIO + IVA
46-02-306	6"	Pza.	6	-	
46-02-312	12"	Pza.	6	-	

PRENSA ESQUINERA



CODIGO	MEDIDA/TIPO	UN.		MIN	PRECIO + IVA
46-02-330	3"	Pza.	20	-	

BROCAS PLANAS PARA MÁQUINA

En estuche individual plástico



CODIGO	MEDIDA/TIPO	UN.		MIN	PRECIO + IVA
46-02-022	1/4"	Pza.	-	-	
46-02-024	3/8"	Pza.	-	-	
46-02-028	1/2"	Pza.	-	-	
46-02-030	5/8"	Pza.	-	-	
46-02-032	3/4"	Pza.	-	-	
46-02-034	7/8"	Pza.	-	-	
46-02-036	1"	Pza.	-	-	
46-02-038	1.1/8"	Pza.	-	-	
46-02-040	1.1/4"	Pza.	-	-	
46-02-044	1.1/2"	Pza.	-	-	

FORMÓN MANGO PLÁSTICO



CODIGO	MEDIDA/TIPO	UN.		MIN	PRECIO + IVA
46-02-148	1/4"	Pza.	6	-	
46-02-150	1/2"	Pza.	6	-	
46-02-154	1"	Pza.	6	-	

NIVEL TORPEDO

Cuerpo de plástico, con imán



CODIGO	MEDIDA/TIPO	UN.		MIN	PRECIO + IVA
46-03-288	9"	Pza.	-	-	

HUINCHA DE MEDIR MT 1192

Con freno



CODIGO	MEDIDA/TIPO	UN.	MIN	PRECIO + IVA
46-03-012	19 mm x 5 m	Pza.	12	-

HUINCHA DE MEDIR FIBRA DE VIDRIO MT 1223



CODIGO	MEDIDA/TIPO	UN.	MIN	PRECIO + IVA
46-03-205	50 m	Pza.	24	-

ESCOBILLAS ALAMBRE NEGRO



CODIGO	MEDIDA/TIPO	UN.	MIN	PRECIO + IVA
--------	-------------	-----	-----	--------------

Con mango

46-03-232	5 hileras	Pza.	12	-
46-03-234	6 hileras	Pza.	12	-

Sin mango 55 x 180 mm

46-03-240	6 hileras	Pza.	12	-
-----------	-----------	------	----	---

PISTOLA CALAFATEAR

"Azul"



CODIGO	MEDIDA/TIPO	UN.	MIN	PRECIO + IVA
46-03-006	-	Pza.	50	-

PISTOLA CALAFATEAR

"Anaranjada", barra hexagonal

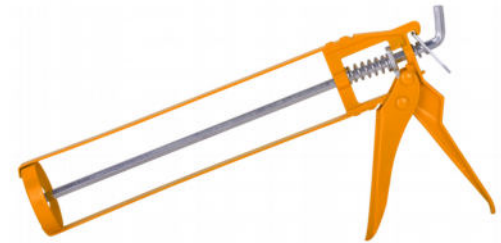

CODIGO	MEDIDA/TIPO	UN.	MIN	PRECIO + IVA
46-03-005	-	Pza.	50	-

DIABLITO



CODIGO	MEDIDA/TIPO	UN.	MIN	PRECIO + IVA
46-03-452	20" - 50 cm	Pza.	24	-

MEZCLADOR DE PINTURA



CODIGO	MEDIDA/TIPO	UN.	MIN	PRECIO + IVA
46-04-001	400 x 80 x 8 mm	Pza.	50	-

LLANA DENTADA
Mango de goma



CODIGO	MEDIDA/TIPO	UN.		MIN	PRECIO + IVA
46-03-426	280 x 130 mm	Pza.	12	-	

PLANA BOTADORA
Mango de madera con extremo metálico



CODIGO	MEDIDA/TIPO	UN.		MIN	PRECIO + IVA
46-03-432	6,5"	Pza.	6	-	
46-03-436	8"	Pza.	6	-	

ESPÁTULA MANGO GOMA



CODIGO	MEDIDA/TIPO	UN.		MIN	PRECIO + IVA
46-03-040	40 mm	Pza.	12	-	
46-03-042	50 mm	Pza.	12	-	
46-03-044	60 mm	Pza.	12	-	
46-03-046	70 mm	Pza.	12	-	
46-03-048	80 mm	Pza.	12	-	
46-03-056	120 mm	Pza.	12	-	

RUEDA NEUMÁTICA PARA CARRETILLA
Con eje de 11"

5 pernos, montada en rodamientos.



CODIGO	MEDIDA/TIPO	UN.		MIN	PRECIO + IVA
26-03-411	350 mm x 8"	Pza.	5	-	

CÁMARA PARA RUEDA DE CARRETILLA



CODIGO	MEDIDA/TIPO	UN.		MIN	PRECIO + IVA
26-03-407	350 mm x 8"	Pza.	-	-	

AZADÓN
Sin mango



CODIGO	MEDIDA/TIPO	UN.		MIN	PRECIO + IVA
46-11-120	2 lb	Pza.	24	-	
46-11-122	2.5 lb	Pza.	24	-	
46-11-124	3 lb	Pza.	24	-	

HACHA MULTIUSO
Mango de goma



CODIGO	MEDIDA/TIPO	UN.		MIN	PRECIO + IVA
46-10-010	13"	Pza.	24	13"	

BARRE HOJAS 22 DIENTES
Sin mango



CODIGO	MEDIDA/TIPO	UN.		MIN	PRECIO + IVA
46-11-110	-	Pza.	6	-	

HORQUETA 4 GANCHOS "FINOS"
Sin mango



CODIGO	MEDIDA/TIPO	UN.		MIN	PRECIO + IVA
46-11-100	700 g	Pza.	24	-	

BOMBA ROTATIVA, PARA TAMBOR
"Bomba de Trasvasije"



CODIGO	MEDIDA/TIPO	UN.		MIN	PRECIO + IVA
--------	-------------	-----	--	-----	--------------

Modelo WS-19

46-20-010	3/4"	Pza.	5	-	
-----------	------	------	---	---	--

Modelo WS-25

46-20-015	1"	Pza.	5	-	
-----------	----	------	---	---	--

POMELES

Golilla latón



CODIGO	MEDIDA/TIPO	UN.		MIN	PRECIO + IVA
46-08-270	3/8" x 70 mm	Par	-	-	
46-08-273	1/2" x 80 mm	Par	-	-	
46-08-276	5/8" x 90 mm	Par	-	-	
46-08-279	3/4" x 100 mm	Par	-	-	
46-08-282	1" x 120 mm	Par	-	-	

BISAGRA CUADRADA, CON TORNILLOS

Envasado en caja por par



CODIGO	MEDIDA/TIPO	UN.		MIN	PRECIO + IVA
46-08-200	2" x 2"	Par	-	-	
46-08-204	2,5" x 2,5"	Par	-	-	
46-08-208	3" x 3"	Par	-	-	
46-08-212	3,5" x 3,5"	Par	-	-	
46-08-216	4" x 4"	Par	-	-	

BISAGRA "T" ESMALTADA NEGRA



CODIGO	MEDIDA/TIPO	UN.		MIN	PRECIO + IVA
46-08-230	4" x 1,2 mm	Par	12	-	
46-08-232	6" x 1,2 mm	Par	12	-	

TRAMPA RATÓN Y LAUCHA



CODIGO	MEDIDA/TIPO	UN.		MIN	PRECIO + IVA
46-20-025	175 x 95 mm	Pza.	2	2	
46-20-027	120 x 65 mm	Pza.	12	12	

PICAPORTE ESMALTADO NEGRO PARA TORNILLOS



CODIGO	MEDIDA/TIPO	UN.		MIN	PRECIO + IVA
46-08-312	200 mm	Pza.	5	-	

CUCHILLOS CARTONEROS



Mod. 80C

Mod. 548

CODIGO	MEDIDA/TIPO	UN.	MIN	PRECIO + IVA
49-20-010	80C	Pza.	25	-
49-20-012	548 Con refuerzo	Pza.	24	-

HOJAS DE REPUESTO PARA CUCHILLOS CARTONEROS

Set 10 hojas

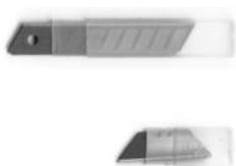

CODIGO	MEDIDA/TIPO	UN.	MIN	PRECIO + IVA
49-20-025	Modelos 80C y 548	Jgo.	20	-
49-20-024	Hoja corta	Jgo.	20	-

ABRAZADERA PARA MANGUERA



CODIGO	MEDIDA/TIPO	UN.	MIN	PRECIO + IVA
46-08-054	6 x 13 mm (1/2")	Pza.	200	-
46-08-056	10 x 19 mm (3/4")	Pza.	200	-
46-08-062	22 x 32 mm (1"-1.1/4")	Pza.	100	-
46-08-070	38 x 51 mm (1.1/4"-2")	Pza.	100	-

CUERDA DE POLYESTER BLANCO



CODIGO	MEDIDA/TIPO	UN.	MIN	PRECIO + IVA
26-20-003	3 mm x 20 m	Rollo	50	-
26-20-004	4 mm x 20 m	Rollo	40	-
26-20-006	6 mm x 20 m	Rollo	30	-
26-20-008	8 mm x 20 m	Rollo	20	-
26-20-010	10 mm x 20 m	Rollo	15	-

NYLON PARA ORILLADORA, PROFESIONAL



CODIGO	MEDIDA/TIPO	UN.	MIN	PRECIO + IVA
--------	-------------	-----	-----	--------------

Liso

46-11-070	1.7 mm x 15 m	Pza.	10	-
46-11-072	1.7 mm x 50 m	Pza.	10	-
46-11-075	2.0 mm x 15 m	Pza.	12	-
46-11-080	2.0 mm x 50 m	Pza.	15	-
46-11-085	2.7 mm x 15 m	Pza.	10	-
46-11-090	2.7 mm x 50 m	Pza.	10	-

Liso, en Bobina

46-11-083	2.0 mm x 250 m	Pza.	8	-
46-11-093	2.7 mm x 250 m	Pza.	8	-

BALANZA RELOJ

2 ganchos

Caja litografiada



CODIGO	MEDIDA/TIPO	UN.		MIN	PRECIO + IVA
46-11-035	25 kg	Pza.	-	-	
46-11-037	50 kg	Pza.	-	-	
46-11-039	100 kg	Pza.	-	-	

CADENAS PARA PERRO



CODIGO	MEDIDA/TIPO	UN.		MIN	PRECIO + IVA
19-20-172	3.5 mm x 1.2 m	Pza.	12	-	

PROTECTOR FACIAL



CODIGO	MEDIDA/TIPO	UN.		MIN	PRECIO + IVA
19-22-100	22 x 33 cm	Pza.	8	-	

MASCARILLA QUIRÚRGICA

Caja 50 unidades



CODIGO	MEDIDA/TIPO	UN.		MIN	PRECIO + IVA
46-22-001	PP2360C	Caja 50	1	-	

BARRA EXTENSORA INDUSTRIAL

Fabricada en cromo vanadio



CODIGO	REF.	MEDIDA/TIPO	UN.		PRECIO + IVA
03-01-033	HEB12051	1/2" x 5"	Pza.	12	
03-01-035	HEB12101	1/2" x 10"	Pza.	6	

DADO HEXAGONAL CROMADO

Tratados térmicamente



CODIGO	REF.	MEDIDA/TIPO	UN.		PRECIO + IVA
03-01-060	HHAST12081	1/2" x 8 mm	Pza.	20	
03-01-062	16509	1/2" x 9 mm	Pza.	20	
03-01-064	HHAST12101	1/2" x 10 mm	Pza.	20	
03-01-066	HHAST12111	1/2" x 11 mm	Pza.	20	
03-01-068	HHAST12121	1/2" x 12 mm	Pza.	20	
03-01-070	HHAST12131	1/2" x 13 mm	Pza.	20	
03-01-072	HHAST12141	1/2" x 14 mm	Pza.	20	
03-01-074	HHAST12151	1/2" x 15 mm	Pza.	20	
03-01-076	HHAST12161	1/2" x 16 mm	Pza.	20	
03-01-078	HHAST12171	1/2" x 17 mm	Pza.	15	
03-01-080	HHAST12181	1/2" x 18 mm	Pza.	15	
03-01-082	HHAST12191	1/2" x 19 mm	Pza.	15	
03-01-084	HHAST12201	1/2" x 20 mm	Pza.	15	
03-01-086	HHAST12211	1/2" x 21 mm	Pza.	15	
03-01-088	HHAST12221	1/2" x 22 mm	Pza.	12	
03-01-090	16523	1/2" x 23 mm	Pza.	12	
03-01-092	HHAST12241	1/2" x 24 mm	Pza.	12	
03-01-094	HHAST12271	1/2" x 27 mm	Pza.	6	
03-01-096	HHAST12301	1/2" x 30 mm	Pza.	6	
03-01-098	HHAST12321	1/2" x 32 mm	Pza.	6	

CHICHARRA

Fabricado en cromo molibdeno

Trinquete reversible



CODIGO	REF.	MEDIDA/TIPO	UN.		PRECIO + IVA
03-01-030	HRT0812	1/2"	Pza.	5	

JUEGO DE DADOS 25 PIEZAS

1/2"

Acero cromo vanadio

CONTENIDO:

18 dados de 1/2": 10, 11, 12, 13, 14, 15, 16, 17, 18, 19, 20, 21, 22, 23, 24, 27, 30, 32 mm

2 dados para bujías: 16,21 mm

1 matraca.

2 extensiones: 125, 250 mm

1 nudo universal.

1 adaptador de 3 puntas.



CODIGO	REF.	MEDIDA/TIPO	UN.		PRECIO + IVA
03-01-040	HKTS12251	-	Jgo.	4	

CEPILLO DE ALAMBRE

Alambre de acero



CODIGO	REF.	MEDIDA/TIPO	UN.	PRECIO + IVA
03-01-110	HWB02250	250 mm	Pza. 24	

LLAVE FRANCESA



CODIGO	REF.	MEDIDA/TIPO	UN.	PRECIO + IVA
03-01-020	HADW131062	6" / apertura 0-19mm	Pza. 6	
03-01-022	HADW131082	8" / apertura 0-24mm	Pza. 6	
03-01-024	HADW131102	10" / apertura 0-30mm	Pza. 6	
03-01-026	HADW131122	12" / apertura 0-35mm	Pza. 6	

MAZO DE GOMA

Mango de fibra de vidrio



CODIGO	REF.	MEDIDA/TIPO	UN.	PRECIO + IVA
03-01-200	HRUH8216	16 Oz	Pza. 6	

PRENSA C



CODIGO	REF.	MEDIDA/TIPO	UN.	PRECIO + IVA
03-02-052	HGC0104	4"	Pza. 10	

TORNILLO DE BANCO

Para joyería y cerrajería

Base giratoria con yunque



CODIGO	REF.	MEDIDA/TIPO	UN.	PRECIO + IVA
03-02-025	HBV082	60 mm / 1.7 kg	Pza. 10	

TORNILLO DE BANCO

Mandíbulas endurecidas y templadas

Base giratoria con yunque



CODIGO	REF.	MEDIDA/TIPO	UN.	PRECIO + IVA
03-02-027	HBV086	6" / 11,2 kg	Pza. 1	

PRENSA SARGENTO



CODIGO	REF.	MEDIDA/TIPO	UN.	PRECIO + IVA
03-02-058	HFC020502	8"	Pza. 12	
03-02-062	HFC020802	12"	Pza. 12	
03-02-063	HFC021202	20"	Pza. 10	

MARTILLO CARPINTERO

Mango fibra revestido en goma

Cabeza de acero carbono termotratado para mayor duración



CODIGO	REF.	MEDIDA/TIPO	UN.		PRECIO + IVA
03-33-003	HCH80808	8 oz	Pza.	6	
03-33-005	HCH80816	16 oz	Pza.	6	

MARTILLO DE COTA

Mango fibra revestido en goma

Cabeza de acero carbono termotratado para mayor duración



CODIGO	REF.	MEDIDA/TIPO	UN.		PRECIO + IVA
03-33-010	HMH880500	500 g	Pza.	6	

PUNTO CON PROTECTOR

Acero al carbono



CODIGO	REF.	MEDIDA/TIPO	UN.		PRECIO + IVA
03-03-120	HCC0841016	10"	Pza.	6	
03-03-124	HCC0841218	12"	Pza.	6	

CINCEL CON PROTECTOR

Acero al carbono



CODIGO	REF.	MEDIDA/TIPO	UN.		PRECIO + IVA
03-03-126	HCCL082210	10"	Pza.	6	
03-03-128	HCCL082412	12"	Pza.	6	

DIABLITO

Forjado en acero carbono termotratado

Puntas pulidas



CODIGO	REF.	MEDIDA/TIPO	UN.		PRECIO + IVA
03-02-070	HWBA01242	60 cm	Pza.	-	

HUINCHA DE MEDIR

Recubrimiento de goma contra impacto



CODIGO	REF.	MEDIDA/TIPO	UN.	PRECIO + IVA
03-03-005	HSMT0803	16mm x 3 m	Pza. 12	
03-03-007	HSMT0805	19mm x 5 m	Pza. 12	
03-03-009	HSMT0808	25mm x 8 m	Pza. 6	

HUINCHA MEDIR LARGA

Cinta de fibra de vidrio

Caja plástica con mango metálico
Presentación en caja individual



CODIGO	REF.	MEDIDA/TIPO	UN.	PRECIO + IVA
03-03-012	HFMT8130	30 m	Pza. -	

NIVEL TORPEDO

3 aguas, cuerpo de aluminio



CODIGO	REF.	MEDIDA/TIPO	UN.	PRECIO + IVA
03-03-038	HMSL01030	22,5 cm	Pza. 60	

NIVEL ALUMINIO

3 aguas



CODIGO	REF.	MEDIDA/TIPO	UN.	PRECIO + IVA
03-03-040	HSL18040	40 cm	Pza. 50	
03-03-043	HSL18060	60 cm	Pza. 50	
03-03-045	HSL18080	80 cm	Pza. 50	
03-03-047	HSL18100	100 cm	Pza. 50	
03-03-049	HSL18120	120 cm	Pza. 50	

CEPILLO PARA CARPINTERO

Cuerpo metálico, base lisa y manillas plásticas



CODIGO	REF.	MEDIDA/TIPO	UN.	PRECIO + IVA
03-02-040	HPL01300	235 x 44 mm	Pza. 6	

SERRUCHO CARPINTERO

7 dientes por pulgada

Hoja tratada térmicamente



CODIGO	REF.	MEDIDA/TIPO	UN.	PRECIO + IVA
03-02-030	HHAS08400	16"	Pza. 10	
03-02-032	HHAS08450	18"	Pza. 10	
03-02-034	HHAS08500	20"	Pza. 10	

SERRUCHO COSTILLA

Dientes tratados térmicamente



CODIGO	REF.	MEDIDA/TIPO	UN.	PRECIO + IVA
03-03-032	HMBSB3008	12"	Pza. 6	

JUEGO CAJA INGLETE CON SERRUCHO COSTILLA 12"

Cuerpo de plástico ABS grosor 0.9 mm



CODIGO	REF.	MEDIDA/TIPO	UN.	PRECIO + IVA
03-03-030	HMBS3008	300 x 140 x 80mm	Jgo. 12	

SERRUCHO PARA PANELES

Mango plástico bicolor



CODIGO	REF.	MEDIDA/TIPO	UN.	PRECIO + IVA
03-02-028	HWBSW68	6"	Pza. 6	

MINI ARCO SIERRA



CODIGO	REF.	MEDIDA/TIPO	UN.	PRECIO + IVA
03-03-024	MHHF1505	6"	Pza. 12	

ARCO SIERRA CON MANGO PLÁSTICO

Cuerpo de acero tubular

Acabado negro pulido con mango de plástico ABS ergonómico



CODIGO	REF.	MEDIDA/TIPO	UN.	PRECIO + IVA
03-03-020	HHFS3068	12"	Pza. 6	

ARCO SIERRA INDUSTRIAL, MANGO ALUMINIO

Cuerpo de acero resistente, mango de aluminio ergonómico

Mecanismo de cambio de hoja con liberación rápida

Tensión ajustable



CODIGO	REF.	MEDIDA/TIPO	UN.	PRECIO + IVA
03-03-022	HHF3008	12"	Pza. 6	

PLANA LENGUETA

Mango fibra



CODIGO	REF.	MEDIDA/TIPO	UN.	PRECIO + IVA
03-03-053	HBT818	8"	Pza. 12	

ESPÁTULA

Hoja de acero carbono con pulido espejo, mango fibra



CODIGO	REF.	MEDIDA/TIPO	UN.	PRECIO + IVA
03-03-092	HPUT08060	60 mm	Pza. 12	
03-03-094	HPUT08080	80 mm	Pza. 12	
03-03-096	HPUT08100	100 mm	Pza. 12	
03-03-098	HPUT08150	150 mm	Pza. 12	

LLANA RECTA

Mango madera



CODIGO	REF.	MEDIDA/TIPO	UN.	PRECIO + IVA
03-03-060	HPT28138	280 x 120 mm	Pza. 12	

LLANA DENTADA

Dientes de 10 mm, mango madera



CODIGO	REF.	MEDIDA/TIPO	UN.	PRECIO + IVA
03-03-062	HPTT28138	280 x 120 mm	Pza. 12	

RASPADOR DE VIDRIOS

Tamaño de la hoja: 61 x 19 mm



CODIGO	REF.	MEDIDA/TIPO	UN.	PRECIO + IVA
03-04-002	HGS31751	70 x 175 mm	Pza. 10	

CORTADOR AZULEJOS

Cuchillas de carburo tungsteno intercambiables: Ø16 x Ø6 x 3 mm
Espesor de corte máximo: 12 mm



CODIGO	REF.	MEDIDA/TIPO	UN.	PRECIO + IVA
03-03-070	HTC04600	600 mm	Pza. 4	

SET ALBAÑIL

8 piezas

INCLUYE:

- 1 cuchara de albañilería de 150 mm (6 ")
- 1 cuchara de albañilería de 200 mm (8 ")
- 1 llana de enyesado de 280 x 130 mm con dientes.
- 1 espátula de masilla multiplicación de 60 mm.
- 1 espátula de masilla de 150 mm.
- 1 espátula para cinta de paneles de yeso de 200 mm
- 1 llana hule de lechada de goma de 240 x 100 mm.
- 1 bandeja de barro de plástico de 30 cm.



CODIGO	REF.	MEDIDA/TIPO	UN.	PRECIO + IVA
03-03-130	COS23076	-	Set -	

CORTADOR DE TUBOS DE PVC

Cuerpo de aleación de aluminio

Hoja de acero 65 Mn
Longitud: 193 mm
Diámetro de corte: 3-42m



CODIGO	REF.	MEDIDA/TIPO	UN.		PRECIO + IVA
03-06-020	HPC0543	-	Pza.	6	

CORTADOR DE TUBOS DE COBRE

Diámetro de corte: 3-32 mm

Cuerpo de aleación de aluminio



CODIGO	REF.	MEDIDA/TIPO	UN.		PRECIO + IVA
03-06-024	HPC0232	-	Pza.	10	

CORTA VIDRIOS

Mango madera con cabeza cromada

Presentación display



CODIGO	REF.	MEDIDA/TIPO	UN.		PRECIO + IVA
03-03-080	HGCT02	130 mm	Pza.	12	

LLAVE STILLSON

Acero carbono de alta calidad



CODIGO	REF.	MEDIDA/TIPO	UN.		PRECIO + IVA
03-06-005	HPW0810	10" / apertura 0-34mm	Pza.	24	
03-06-008	HPW0812	12" / apertura 0-42mm	Pza.	12	
03-06-010	HPW0814	14" / apertura 0-50mm	Pza.	8	

TIJERA DE AVIACIÓN RECTA

Cabeza forjada

Mango plástico bicolor
Presentación en display



CODIGO	REF.	MEDIDA/TIPO	UN.		PRECIO + IVA
03-20-004	HTSN01125	10"	Pza.	5	

REMACHADORA

Cuerpo de acero reforzado

Para remaches de:
2.4mm (3/32"), 3.2mm (1/8"), 4,0 mm (5/32"), 4,8 mm (3/16")
Incluye llave
En display



CODIGO	REF.	MEDIDA/TIPO	UN.		PRECIO + IVA
03-20-010	HR104	-	Pza.	6	

ENGRAPADORA INDUSTRIAL, USO PESADO

Cuerpo aluminio

Grapas de 6-14 mm / 10.6 y 11.3 mm (grosor 1.2 mm)
Incluye set de 1000 grapas



CODIGO	REF.	MEDIDA/TIPO	UN.		PRECIO + IVA
03-08-001	HSG1404	-	Pza.	6	

ENGRAPADORA USO MEDIO

Cuerpo aluminio

Grapas de 4-14 mm / 11.3 mm (grosor 0.7 mm)



CODIGO	REF.	MEDIDA/TIPO	UN.		PRECIO + IVA
03-08-003	HSG1403	-	Pza.	10	

GRAPAS

Caja 1000 unidades



CODIGO	REF.	MEDIDA/TIPO	UN.		PRECIO + IVA
03-08-012	STS0108	0,7 x 8 mm	Caja	100	
03-08-020	STS0208	1,2 x 8 mm	Caja	100	
03-08-022	STS0210	1,2 x 10 mm	Caja	100	
03-08-024	STS0212	1,2 x 12 mm	Caja	100	

CUCHILLO CARTONERO INDUSTRIAL

Carcasa plástica, interior de aluminio



CODIGO	REF.	MEDIDA/TIPO	UN.		PRECIO + IVA
03-12-003	HKNS110915	9 x 80 mm	Pza.	12	

Repuesto Set 10 hojas

03-12-014	HKNSB0901	9 x 80 mm	Set 10	40	
-----------	-----------	-----------	--------	----	--

CUCHILLO CARTONERO INDUSTRIAL

Cuerpo de aluminio



CODIGO	REF.	MEDIDA/TIPO	UN.		PRECIO + IVA
03-12-001	HKNS11807	18 x 100 mm	Pza.	12	

Repuesto Set 10 hojas

03-12-012	HKNSB181	18 x 100 mm	Set 10	10	
-----------	----------	-------------	--------	----	--

CUCHILLO CARTONERO PROFESIONAL

Cuerpo de aleación aluminio



CODIGO	REF.	MEDIDA/TIPO	UN.		PRECIO + IVA
03-12-005	HUKB615	19 x 61 mm	Pza.	12	

Repuesto hoja corta Set 10 hojas

03-12-010	HUKB611	19 x 61 mm	Set 10	20	
-----------	---------	------------	--------	----	--

TIJERA UNIVERSAL

Hojas de acero inoxidable



CODIGO	REF.	MEDIDA/TIPO	UN.		PRECIO + IVA
03-13-002	HSCRS812801	11"	Pza.	25	

BOTAS DE LLUVIA PARA TRABAJO

Material virgen de PVC / nitrilo Altura: 37 cm
Resistencia a aceites de alto nivel, ácido, álcalis 100%
Resistente al agua
Empaque en bolsa de polietileno



CODIGO	REF.	MEDIDA/TIPO	UN.		PRECIO + IVA
03-22-010	SSH092LYB39	39	Par.	6	
03-22-012	SSH092LYB40	40	Par.	6	
03-22-014	SSH092LYB41	41	Par.	6	
03-22-016	SSH092LYB42	42	Par.	6	
03-22-018	SSH092LYB43	43	Par.	6	
03-22-020	SSH092LYB44	44	Par.	6	

MASCARILLA POLIESTER

Para protección contra polvo

Sujeción elástica y clip nasal



*imagen de la caja referencial

CODIGO	REF.	MEDIDA/TIPO	UN.		PRECIO + IVA
03-22-001	HDM04	-	Caja 50	-	

TRANSPALETA HIDRÁULICA

Ruedas de poliuretano

ESPECIFICACIONES

Ancho Exterior: 550 mm
Ancho Interior: 230 mm
Largo: 1150 mm
Altura Máxima Horquillas: 200 mm
Altura Mínima Horquillas: 85 mm
Capacidad de Carga: 2500 Kg



CODIGO	REF.	MEDIDA/TIPO	UN.		PRECIO + IVA
03-23-010	HHPT01251	2.5 t / Pata angosta	Pza.	6	

GRATA DE COPA ONDULADA

Con toma M14x2

Grosor del alambre 0.3 mm
En caja individual



CODIGO	REF.	MEDIDA/TIPO	UN.	PRECIO + IVA
03-27-005	WB1075	3"	Pza. 60	
03-27-006	WB11001	4"	Pza. 36	

GRATA DE COPA TRENZADA

Con toma M14x2

Grosor del alambre 0.5 mm
en caja individual



CODIGO	REF.	MEDIDA/TIPO	UN.	PRECIO + IVA
03-27-010	WB2075	3"	Pza. 60	
03-27-011	WB21001	4"	Pza. 36	

GRATA CIRCULAR

Vástago de 1/4"

Grosor del alambre 0.3 mm
En display.



CODIGO	REF.	MEDIDA/TIPO	UN.	PRECIO + IVA
03-27-025	WB40751	3"	Pza. 80	

GRATAS DE COPA

Vástago de 1/4"

Grosor del alambre 0.3 mm
En display.



CODIGO	REF.	MEDIDA/TIPO	UN.	PRECIO + IVA
03-27-030	WB70241	1"	Pza. 20	
03-27-032	WB30501	2"	Pza. 10	
03-27-034	WB30751	3"	Pza. 10	

JUEGO DE LIMAS ACERO

6 Piezas

Tipos: Plana, redonda, semicircular, cuadrada, triangular, cuchilla.



CODIGO	REF.	MEDIDA/TIPO	UN.	PRECIO + IVA
03-30-010	HKTF63	140 mm	Jgo. 12	

LIMA REDONDA PARA MADERA



CODIGO	REF.	MEDIDA/TIPO	UN.	PRECIO + IVA
03-30-030	HWRFO88	200 mm	Pza. 10	

03-32-020	HBNP08168	6"	Pza.	6	
-----------	-----------	----	------	---	--

PARA BOMBA DE AGUA



CODIGO	REF.	MEDIDA/TIPO	UN.		PRECIO + IVA
03-32-030	HPP28258	10"	Pza.	6	

ALICATES

Mangos ergonómicos bicolor

Presentación en colgador plástico

UNIVERSAL

En display



CODIGO	REF.	MEDIDA/TIPO	UN.		PRECIO + IVA
03-32-001	HCP28168	6"	Pza.	6	
03-32-003	HCP08188	7"	Pza.	6	
03-32-005	HCP08208	8"	Pza.	6	

CORTE DIAGONAL

En display



CODIGO	REF.	MEDIDA/TIPO	UN.		PRECIO + IVA
03-32-010	HSCP08168	6"	Pza.	6	

PUNTA

En display



CODIGO	REF.	MEDIDA/TIPO	UN.		PRECIO + IVA
03-32-015	HLNP08168	6"	Pza.	6	

PUNTA CURVA



SET ALICATES

4 piezas

INCLUYE:

- 1 alicate universal de 8 "
- 1 alicate corte diagonal de 7 "
- 1 alicate punta de 6 "
- 1 alicate bomba de 10 "



CODIGO	REF.	MEDIDA/TIPO	UN.		PRECIO + IVA
03-32-090	HKTV01P041	-	Set	5	

ALICATES

Mangos ergonómicos un color

UNIVERSAL

En bolsa plástica



CODIGO	REF.	MEDIDA/TIPO	UN.		PRECIO + IVA
03-32-004	HCP08181	7"	Pza.	6	

CORTE DIAGONAL

En bolsa plástica



CODIGO	REF.	MEDIDA/TIPO	UN.		PRECIO + IVA
03-32-012	HDCP08161	6"	Pza.	6	

ALICATES ELECTRICISTA

1000v

UNIVERSAL



TOLSEN

CODIGO	REF.	MEDIDA/TIPO	UN.		PRECIO + IVA
03-32-080	38118	8"	Pza.	6	

PUNTA



TOLSEN

CODIGO	REF.	MEDIDA/TIPO	UN.		PRECIO + IVA
03-32-085	38136	6"	Pza.	6	

CORTE DIAGONAL



CODIGO	REF.	MEDIDA/TIPO	UN.		PRECIO + IVA
03-32-014	HIHLDCP28160	6"	Pza.	6	

SET ALICATES ELECTRICISTA

Universal 8 "
Punta larga 6 "
Corte diagonal 6 "



CODIGO	REF.	MEDIDA/TIPO	UN.		PRECIO + IVA
03-32-024	HIKPS28318		Set	5	

ALICATE SACABOCADOS

Medidas: 2,0mm / 2,5mm / 3,0mm / 3,5mm / 4,0mm / 4,5mm

Presentación en display



CODIGO	REF.	MEDIDA/TIPO	UN.		PRECIO + IVA
03-32-070	HLHP01	9"	Pza.	6	

CAIMÁN BOCA CURVA

Acero carbono forjado, acabado en Níquel



CODIGO	REF.	MEDIDA/TIPO	UN.		PRECIO + IVA
03-32-035	HCJLW0210	10"	Pza.	6	

CAIMÁN CADENA

Acero carbono forjado, acabado en Níquel



CODIGO	REF.	MEDIDA/TIPO	UN.		PRECIO + IVA
03-32-037	HCLP0210	10"	Pza.	5	

TENAZA CARPINTERO

Acabado negro pulido, mangos recubiertos



CODIGO	REF.	MEDIDA/TIPO	UN.		PRECIO + IVA
03-32-050	HCPP02200	8"	Pza.	6	

CORTA PERNO

Hoja de cromo vanadio, acabado negro pulido

Empuñaduras ergonómicas de pvc
Bloqueo en el extremo del mango
Asas de acero
Presentación Display



CODIGO	REF.	MEDIDA/TIPO	UN.		PRECIO + IVA
03-32-056	HMBC0808	8"	Pza.	6	

CORTA PERNO

Hoja de cromo vanadio, acabado negro pulido

Presentación en caja individual



CODIGO	REF.	MEDIDA/TIPO	UN.		PRECIO + IVA
03-32-057	HBC0812	12"	Pza.	20	
03-32-060	HBC0818	18"	Pza.	10	

SERRUCHO PODAR CURVO

Dientes triple filo



CODIGO	REF.	MEDIDA/TIPO	UN.		PRECIO + IVA
03-11-010	HPS33028C	13"	Pza.	6	

TIJERA PODAR TELESCÓPICA

Hoja tratada térmicamente

Diámetro máximo de corte: 40 mm



CODIGO	REF.	MEDIDA/TIPO	UN.		PRECIO + IVA
03-11-002	HLTS7608	650 - 850 mm	Pza.	6	

HACHA CAZADORA

Cabeza forjada, mango fibra de vidrio



CODIGO	REF.	MEDIDA/TIPO	UN.		PRECIO + IVA
03-37-010	HAXS206001	600 g	Pza.	6	

DESTORNILLADORES USO GENERAL

Mango bicolor ergonómico, punta magnética con acabado negro
Presentación en colgador plástico

SET DE 6 PIEZAS

Presentación en caja individual



CODIGO	REF.	MEDIDA/TIPO	UN.		PRECIO + IVA
03-34-030	HKSD0628	-	Jgo.	10	

PALETA



CODIGO	REF.	MEDIDA/TIPO	UN.		PRECIO + IVA
03-34-007	HS684100	4 x 100 mm	Pza.	12	
03-34-009	HS285100	5,5 x 100 mm	Pza.	12	
03-34-011	HS286150	6,5 x 150 mm	Pza.	12	

PHILLIPS



CODIGO	REF.	MEDIDA/TIPO	UN.		PRECIO + IVA
03-34-020	HS68PH0075	PH0 x 75 mm	Pza.	12	
03-34-022	HS68PH1100	PH1 x 100 mm	Pza.	12	
03-34-025	HS68PH2150	PH2 x 150 mm	Pza.	12	

DESTORNILLADORES ELECTRICISTA

1000v

Certificación VDE
Presentación en colgador plástico

SET DE 6 PIEZAS

Presentación en caja individual

Incluye probador de corriente

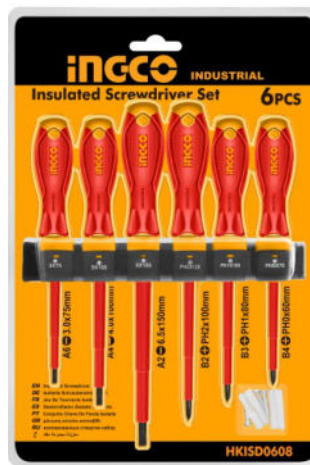

CODIGO	REF.	MEDIDA/TIPO	UN.		PRECIO + IVA
03-34-070	HKISD0608	-	Jgo.	10	

PALETA



CODIGO	REF.	MEDIDA/TIPO	UN.		PRECIO + IVA
03-34-052	HISD814100	4 x 100 mm	Pza.	12	
03-34-054	HISD815125	5,5 x 125 mm	Pza.	12	
03-34-056	HISD816150	6,5 x 150 mm	Pza.	12	

PHILLIPS



CODIGO	REF.	MEDIDA/TIPO	UN.		PRECIO + IVA
03-34-062	HISD81PH180	PH1 x 80 mm	Pza.	12	
03-34-064	HISD81PH2100	PH2 x 100 mm	Pza.	12	

ORILLADORA DE PASTO INALÁMBRICA

Voltaje: 20 V
 Velocidad sin carga: 8200 / min
 Diámetro de corte: 300 mm
 Diámetro de la línea: 1,6 mm retorcido
 Longitud de la línea: 5 m
 Con paquete de batería 1pcs
 Con cargador inteligente rápido 1pcs
 Voltios de carga:
 220V-240V ~ 50 / 60Hz



CODIGO	REF.	MEDIDA/TIPO	UN.	Pza.	PRECIO + IVA
03-42-010	CGTLI20301	-	Pza.	2	

TALADRO PERCUTOR ATORNILLADOR INALÁMBRICO

ESPECIFICACIONES:
 Voltaje: 20 V
 Velocidad sin carga: 0-400 / 0-1500 / min
 Tasa de impacto máx.: 22500 / min
 Fuerza de torque máx.: 45NM
 Capacidad del portabrocas: 0,8-10 mm
 Ajustes de par: 18 + 1 + 1
 Engranaje mecánico de 2 velocidades
 Luz de trabajo integrada
 Indicador LED de carga de la batería

INCLUYE:
 1 Maletín plástico duro
 1 Cargador rápido 220V-240V ~ 50 / 60Hz
 2 Baterías P20S de iones de litio de 20V / 2A
 1 Punta combinada imantada PH2 - plana 6 mm
 3 brocas mampostería 4,5 y 6 mm
 1 Manual de operación



CODIGO	REF.	MEDIDA/TIPO	UN.	Pza.	PRECIO + IVA
03-42-002	CIDLI200215	-	Pza.	8	

ESMERIL INALÁMBRICO

ESPECIFICACIONES:

Voltaje: 20V
 Velocidad sin carga: 3000 / 8500 / min
 Diámetro del disco: 115mm
 Rosca: M14

INCLUYE:
 2 Baterías P20S de iones de litio de 20V / 4A
 1 Cargador rápido 220V-240V ~ 50 / 60Hz
 1 llave de ajuste
 10 discos metal 4.1/2"
 1 Estuche de lona
 1 Manual de operación



CODIGO	REF.	MEDIDA/TIPO	UN.	Pza.	PRECIO + IVA
03-42-004	CAGLI2011582	-	Pza.	6	



Certificado SEC,
 solo para artículos
 que lo requieren



BATERIA

Voltaje: 20V
 Batería de iones de litio de 5,0 Ah
 Indicador LED de energía de la batería
 Apto para múltiples herramientas de 20V



CODIGO	REF.	MEDIDA/TIPO	UN.	PRECIO + IVA
03-42-014	FBLI2003	P20S	Pza. 12	

CARGADOR RÁPIDO

Para baterías P20S

Voltaje de entrada nominal :110V-240V~50/60Hz
 Voltaje de salida: 20V
 Corriente de carga:2A
 Entrada nominal poder: 50W



CODIGO	REF.	MEDIDA/TIPO	UN.	PRECIO + IVA
03-27-040	FCLI2001	-	Pza. 20	

PISTOLA DE SILICONA INALÁMBRICA

ESPECIFICACIONES:
 Voltaje: 20V
 Capacidad de encolado: 13-18g / min.
 Barra de pegamento, diámetro: 11,2 mm
 Tiempo de calentamiento: 60 segundos

INCLUYE:
 3 barras de silicona de 11,2 mm
 1 Manual de operación

No incluye batería ni cargador



CODIGO	REF.	MEDIDA/TIPO	UN.	PRECIO + IVA
03-42-006	CGGLI2001	-	Pza. 36	

PISTOLA PINTAR INALÁMBRICA

ESPECIFICACIONES:
 Voltaje: 20V
 Máx viscosidad: 40 din-s
 Máx presión de pulverización: 0.1 - 0.2 bar
 Flujo máx de pulverización: 600 ml / min
 Capacidad del tanque: 800 ml
 Tamaño de la boquilla: 2.5m/s²

INCLUYE:
 1 Medidor de viscosidad
 1 varilla de limpieza
 1 Manual de operación

No incluye batería ni cargador



CODIGO	REF.	MEDIDA/TIPO	UN.	PRECIO + IVA
03-42-008	CSGLI2001	-	Pza. 8	

Estos artículos
 no requieren
 certificación

JGO. 8 LLAVES ALLEN PLEGABLES PRO
Estructura bi-material con textura patentada

- Diseño ergonómico



MEDIDAS:
1.5, 2, 2.5, 3, 4, 5, 6 & 8 mm
T9, T10, T15, T20, T25, T27, T30 & T40

CODIGO	REF	MEDIDA/TIPO	UN.	PRECIO + IVA
02-01-006	69-264	Métricas	Jgo. 24	
02-01-008	69-266	Torx	Jgo. 24	

SERRUCHO JETCUT
Hoja de acero pulido resistente a la corrosión

- Dientes endurecidos por inducción con 3 caras de afilado, cortan 50% más rápido que los serruchos convencionales
- El mango puede usarse como escuadra de 45° y 90°



CODIGO	REF	MEDIDA/TIPO	UN.	PRECIO + IVA
02-02-006	20-088	22" / 8 dpp	Pza. 6	

FORMÓN
Serie 5000

- Lámina de acero endurecido y templado, retiene el filo por mayor tiempo
- Envase display



CODIGO	REF	MEDIDA/TIPO	UN.	PRECIO + IVA
02-02-082	16-118	1.1/2"	Pza. 12	

DIABLITO
Acero alto carbono para mayor fuerza de palanca

- Extremos de uña y del cincel pulidos



CODIGO	REF	MEDIDA/TIPO	UN.	PRECIO + IVA
02-03-082	55-124	19 mm x 24"	Pza. 6	

LLAVE STILLSON
Cuerpo de hierro nodular

- Mordaza forjada en acero Cromo Molibdeno
- Construcción en vigueta doble "T" para mayor resistencia y durabilidad



CODIGO	REF	MEDIDA/TIPO	UN.	PRECIO + IVA
02-06-022	87-623	12"	Pza. 6	
02-06-024	87-624	14"	Pza. 6	
02-06-026	87-625	18"	Pza. 2	
02-06-028	87-626	24"	Pza. 1	

MARTILLO MECÁNICO
Mango madera

- Cabeza completamente pulida
- Cabeza fijada con 2 cuñas para más durabilidad
- Mango 25% más largo para mejor equilibrio y control



CODIGO	REF	MEDIDA/TIPO	UN.	PRECIO + IVA
02-33-016	54-191	16 oz	Pza. 6	
02-33-020	54-193	32 oz	Pza. 6	

CAJA DE HERRAMIENTAS
Serie 2000

- 2 organizadores en la tapa
- Incluye bandeja
- Cierres metálicos
- Herramientas y accesorios no incluidos



CODIGO	REF	MEDIDA/TIPO	UN.	PRECIO + IVA
02-23-006	24-013s	24"	Pza. 2	

ATOMIZADOR



CODIGO	REF.	MEDIDA/TIPO	UN.		PRECIO + IVA
19-11-100	-	500 ml	Pza.	100	

FUMIGADOR DOMÉSTICO



CODIGO	REF.	MEDIDA/TIPO	UN.		PRECIO + IVA
19-11-102	-	1,5 L	Pza.	20	

FUMIGADOR



CODIGO	REF.	MEDIDA/TIPO	UN.		PRECIO + IVA
19-11-104	-	5 L	Pza.	6	

HACHA CASCO S/MANGO

Hacha marca "Casco" original
Made in Germany

CODIGO	MEDIDA/TIPO	UN.		MIN.	PRECIO + IVA
44-11-010	4,0 lb	Pza.	-	-	
44-11-012	4,5 lb	Pza.	-	-	
44-11-014	5,0 lb	Pza.	-	-	



HACHA C/MANGO 11118

Largo total 38 cm

Hacha de mano, hoja completamente pulida, mango de haya natural,
No incluye colgador y protector de filo.

CODIGO	MEDIDA/TIPO	UN.		MIN.	PRECIO + IVA
44-11-027	800 g	Pza.	6	-	



HACHA C/MANGO 11308

Largo total 38 cm

Hacha de mano, calidad "Premium" según DIN 5131.
Hoja pulida en zona de corte, el resto dorado, mango de Fresno barnizado y pintado.
Colgador sistema EURO y protector de filo de goma.

CODIGO	MEDIDA/TIPO	UN.		MIN.	PRECIO + IVA
44-11-025	800 g	Pza.	6	-	



HACHA C/MANGO 10512

Largo total 70 cm

Hacha profesional, hoja pintada en rojo, con pulido en borde, mango de haya natural.
Colgador sistema EURO.

CODIGO	MEDIDA/TIPO	UN.		MIN.	PRECIO + IVA
44-11-020	1.250 g	Pza.	6	-	



MALLA MOSQUITERA FIBRA DE VIDRIO

Absolutamente resistente a la radiación solar y a cambios de temperatura bruscos

CODIGO	MEDIDAS ROLLO / ORIFICIOS PP	COLOR	UN.		PRECIO + IVA
36-03-107	0.91 x 30 m / 14 x 14	Blanco	Rollo	10	
36-03-116	1.20 x 30 m / 14 x 14	Blanco	Rollo	10	
36-03-108	0.91 x 30 m / 14 x 14	Negro	Rollo	10	
36-03-118	1.20 x 30 m / 14 x 14	Negro	Rollo	10	
36-03-101	0.91 x 30 m / 14 x 14	Verde oscuro	Rollo	10	
36-03-112	1.20 x 30 m / 14 x 14	Verde oscuro	Rollo	10	
36-03-104	0.91 x 30 m / 14 x 14	Verde claro	Rollo	10	
36-03-110	0.91 x 30 m / 14 x 14	Celeste	Rollo	10	
36-03-120	1.20 x 30 m / 14 x 14	Celeste	Rollo	10	

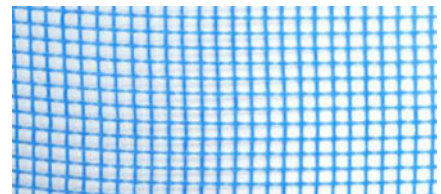
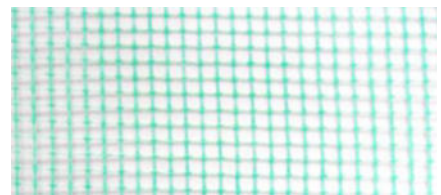
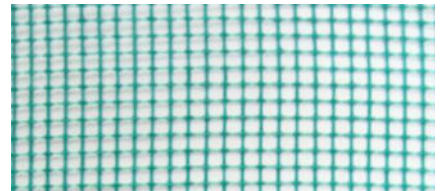
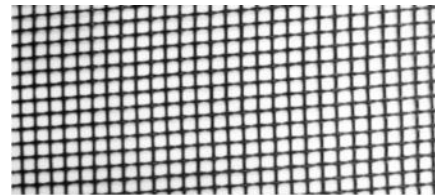

SERRUCHO DE PODAR PROFESIONAL

Mango de madera barnizado, con dos remaches



CODIGO	REF.	MEDIDA/TIPO	UN.		PRECIO + IVA
60-11-108	1712	12" - 7 dpp	Pza.	6	
60-11-112	1714	14" - 7 dpp	Pza.	6	

SERRUCHO DE COSTILLA

Mango cerrado de madera barnizado, con dos remaches

Ancho de la hoja 90mm, espesor 0.7mm



CODIGO	REF.	MEDIDA/TIPO	UN.		PRECIO + IVA
60-02-133	1612	12" - 9 dpp	Pza.	6	

SERRUCHO DE PUNTA

Mango cerrado de madera barnizado, con dos remaches

Espesor de la hoja 1.0mm



CODIGO	REF.	MEDIDA/TIPO	UN.		PRECIO + IVA
60-02-100	1512	12" - 9 dpp	Pza.	6	

REPUESTOS PARA SERRUCHO

Mango "sin orificio"



Juego de pernos
venta min. 10 juegos



CODIGO	REF.	MEDIDA/TIPO	UN.		PRECIO + IVA
60-02-205	2401	Mango serrucho	Pza.	10	
60-02-207	2408	Juego de pernos	Pza.	10	

ARCO DE SIERRA CARNICERO

Mango madera

Con hoja de 3/4" de ancho. Mango de madera barnizado con 3 pernos cincados



CODIGO	REF.	MEDIDA/TIPO	UN.		PRECIO + IVA
60-20-050	5518	18" - 9 dpp	Pza.	6	

ARCO DE SIERRA CARNICERO

Mango plástico



CODIGO	REF.	MEDIDA/TIPO	UN.		PRECIO + IVA
60-20-055	5517	18" - 9 dpp	Pza.	6	

REPUESTOS PARA ARCO SIERRA CARNICERO

Hoja Sierra

9 dientes x pulgada
Acero alto carbono



Perno



CODIGO	REF.	MEDIDA/TIPO	UN.		PRECIO + IVA
60-20-090	5894	Hoja sierra 3/4" x 18"	Pza.	100	
60-20-200	-	Perno	Pza.	-	

PLOMADAS

Cuerpo de acero macizo, con cordón de nylon 2 m

Centro

Taco de aluminio



CODIGO	REF.	MEDIDA/TIPO	UN.		PRECIO + IVA
60-03-056	1682	300 g	Pza.	6	
60-03-058	1683	400 g	Pza.	6	

De pared

Taco de madera tratada y pulida



CODIGO	REF.	MEDIDA/TIPO	UN.		PRECIO + IVA
60-03-040	1463	500 g	Pza.	6	

De pared plástica

Taco de plástico



CODIGO	REF.	MEDIDA/TIPO	UN.		PRECIO + IVA
60-03-050	3854	410 g	Pza.	6	

ESCUADRAS CARPINTERO

Mango polipropileno



CODIGO	REF.	MEDIDA/TIPO	UN.		PRECIO + IVA
60-02-222	11081	8"	Pza.	6	
60-02-224	11101	10"	Pza.	6	
60-02-226	11121	12"	Pza.	6	
60-02-228	11141	14"	Pza.	6	

Mango metálico

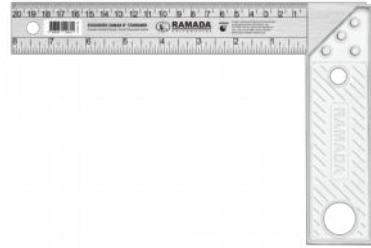

CODIGO	REF.	MEDIDA/TIPO	UN.		PRECIO + IVA
60-02-213	12101	10"	Pza.	6	
60-02-215	12121	12"	Pza.	6	

MAZO DE GOMA

Mango madera

Mazo de goma maciza y flexible, mango de madera



CODIGO	REF.	MEDIDA/TIPO	UN.		PRECIO + IVA
60-01-025	20601	60 mm	Pza.	6	

PALA JARDÍN ROBUSTA

Con mango 120 cm



CODIGO	REF.	MEDIDA/TIPO	UN.		PRECIO + IVA
60-11-185	6827	140 x 200 mm	Pza.	6	

AZADONES

Con mango 120 cm

1 punta



CODIGO	REF.	MEDIDA/TIPO	UN.		PRECIO + IVA
60-11-136	0980	93 x 275 mm	Pza.	6	

2 puntas

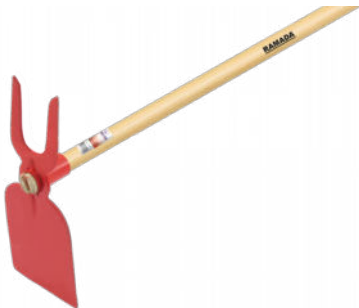

CODIGO	REF.	MEDIDA/TIPO	UN.		PRECIO + IVA
60-11-138	0981	96 x 252 mm	Pza.	6	

Robusto



CODIGO	REF.	MEDIDA/TIPO	UN.		PRECIO + IVA
60-11-148	6831	115 x 155 mm	Pza.	6	

PALITA JARDÍN ANCHA



CODIGO	REF.	MEDIDA/TIPO	UN.		PRECIO + IVA
60-11-189	6826	250 x 92 mm	Pza.	6	

BARRE HOJAS PLÁSTICO

Con mango 120 cm



CODIGO	REF.	MEDIDA/TIPO	UN.		PRECIO + IVA
60-11-152	6836	22 dientes	Pza.	6	

RASTRILLO METÁLICO

Con mango 120 cm

Producido en acero SAE 1020, pintado en negro



CODIGO	REF.	MEDIDA/TIPO	UN.		PRECIO + IVA
60-11-154	0381	14 dientes	Pza.	6	

HACHITA DE MANO

Mango madera

Acero SAE 1045, forjado y templado, pintado en negro, mango de madera



CODIGO	REF.	MEDIDA/TIPO	UN.		PRECIO + IVA
60-10-005	500819	750 g	Pza.	6	

ROZÓN IZQUIERDO Y DERECHO

s/mango



CODIGO	REF.	MEDIDA/TIPO	UN.		PRECIO + IVA
60-11-007	-	11.1/2" izquierdo	Pza.	6	
60-11-005	-	11.1/2" derecho	Pza.	6	

AZADÓN ANCHO

Con mango de 150 cm



CODIGO	REF.	MEDIDA/TIPO	UN.		PRECIO + IVA
60-11-172	0995	C/mango	Pza.	6	

Mango para Azadón

60-11-169	-	150 cm	Pza.	6	
-----------	---	--------	------	---	--

RESORTES TIJERA PODAR

Rioja, Altuna, Chinas, etc.



CODIGO	REF.	MEDIDA/TIPO	UN.		PRECIO + IVA
60-11-123	-	60 mm	Pza.	-	
60-11-126	-	70 mm	Pza.	-	

BISAGRAS PARA PORTONES

Pintadas en negro

Acero SAE 1045, espesor 3/16" (5mm)



CODIGO	REF.	MEDIDA/TIPO	UN.		PRECIO + IVA
60-08-005	0882	Nº1 - 220 x 95mm	Pza.	6	
60-08-007	0884	Nº3 - 280 x 95mm	Pza.	6	

REPUESTO LAMINAS PARA CORTAPERNO

Incluye pieza de anclaje y pernos



CODIGO	REF.	MEDIDA/TIPO	UN.		PRECIO + IVA
60-01-050	-	14" - 3/16"	Pza.	6	
60-01-052	-	18" - 1/4"	Pza.	6	
60-01-054	-	24" - 5/16"	Pza.	6	
60-01-056	-	30" - 3/8"	Pza.	6	

MANGUERA TRANSPARENTE

Calidad extra

- Fabricada a base de materiales no tóxicos.
- Uso para productos alimenticios.
- Manguera de jardín, de nivel, etc.
- Resistente a la torsión o aplastamiento.
- Ligera y resistente, no afecta a la abrasión.
- Resistente a temperaturas desde -5 a 65°C.



CODIGO	REF.	MEDIDA/TIPO	UN.		PRECIO + IVA
--------	------	-------------	-----	--	--------------

Rollo de 50 metros

79-11-040	-	1/2" x 50 m	Rollo	-	
-----------	---	-------------	-------	---	--

Rollo de 100 metros

79-11-038	-	1/4" x 100 m	Rollo	-	
79-11-042	-	3/8" x 100 m	Rollo	-	

MANGUERA JARDÍN

- De alta flexibilidad, ligera y fácil de manejar.
- Protegida contra rayos UV.
- No afecta a fisuras por exposición al sol.
- Resistente a temperaturas desde -5 a 65°C.
- Presión de trabajo máxima 7 bar.

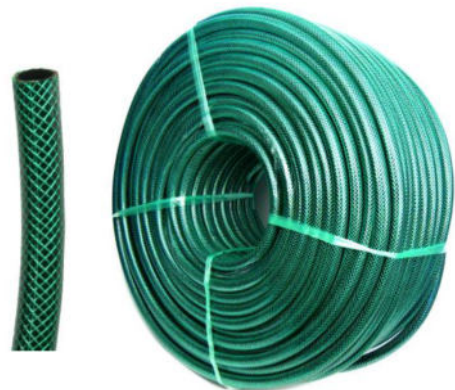

CODIGO	REF.	MEDIDA/TIPO	UN.		PRECIO + IVA
--------	------	-------------	-----	--	--------------

79-11-001	-	1/2" x 100 m	Rollo	-	
79-11-004	-	3/4" x 50 m	Rollo	-	

MANGUERA PARA COMPRESOR DE AIRE

20 bar - 290 PSI

Para compresor y otros dispositivos de aire a presión.
Para trabajo en minería, obras de construcción, climatización, etc.

- Alta durabilidad en condiciones climáticas hostiles.
- Gran flexibilidad y facilidad de manejo.
- No se fisura ante la exposición directa al sol.
- Resistente al frío extremo.
- No se dilata.
- Temperatura de trabajo: -5 °C a 65 °C.



CODIGO	REF.	MEDIDA/TIPO	UN.		PRECIO + IVA
--------	------	-------------	-----	--	--------------

79-29-001	-	1/4" x 100 m	Rollo	-	
79-29-003	-	5/16" x 100 m	Rollo	-	
79-29-005	-	3/8" x 100 m	Rollo	-	

LLAVES DE ACERO CROMO-VANADIO

Terminación cromada, cabezas pulidas

Punta - Punta



CODIGO	REF.	MEDIDA/TIPO	UN.		PRECIO + IVA
52-01-135	-	20 x 22 mm	Pza.	10	

Punta - Corona



CODIGO	REF.	MEDIDA/TIPO	UN.		PRECIO + IVA
52-01-200	-	6 mm	Pza.	10	
52-01-205	-	7 mm	Pza.	10	
52-01-210	-	8 mm	Pza.	10	
52-01-215	-	9 mm	Pza.	10	
52-01-220	-	10 mm	Pza.	10	
52-01-225	-	11 mm	Pza.	10	
52-01-230	-	12 mm	Pza.	10	
52-01-235	-	13 mm	Pza.	10	
52-01-240	-	14 mm	Pza.	5	
52-01-245	-	15 mm	Pza.	5	
52-01-250	-	16 mm	Pza.	5	
52-01-255	-	17 mm	Pza.	5	
52-01-260	-	18 mm	Pza.	5	
52-01-265	-	19 mm	Pza.	5	
52-01-270	-	20 mm	Pza.	5	
52-01-275	-	21 mm	Pza.	5	
52-01-280	-	22 mm	Pza.	5	
52-01-285	-	23 mm	Pza.	5	
52-01-290	-	24 mm	Pza.	5	
52-01-295	-	25 mm	Pza.	5	
52-01-300	-	26 mm	Pza.	5	
52-01-305	-	27 mm	Pza.	5	
52-01-310	-	28 mm	Pza.	5	
52-01-315	-	29 mm	Pza.	5	
52-01-320	-	30 mm	Pza.	5	
52-01-325	-	32 mm	Pza.	5	

Corona - Corona



CODIGO	REF.	MEDIDA/TIPO	UN.		PRECIO + IVA
52-01-386	-	6 x 7 mm	Pza.	10	
52-01-388	-	8 x 9 mm	Pza.	10	
52-01-390	-	10 x 11 mm	Pza.	10	
52-01-392	-	12 x 13 mm	Pza.	10	
52-01-394	-	14 x 15 mm	Pza.	10	
52-01-396	-	16 x 17 mm	Pza.	10	
52-01-398	-	18 x 19 mm	Pza.	10	
52-01-400	-	20 x 22 mm	Pza.	10	
52-01-406	-	25 x 28 mm	Pza.	10	
52-01-408	-	30 x 32 mm	Pza.	10	

JUEGOS LLAVE PUNTA - CORONA



CODIGO	REF.	MEDIDA/TIPO	UN.		PRECIO + IVA
8 Piezas: 6,8,10,11,13,14,17,19 mm					
52-01-355	-	-	Jgo.	8	
10 Piezas: 6,8,10,11,12,13,14,17,19,22 mm					
52-01-360	-	-	Jgo.	6	
12 Piezas: 6 a 14, 17,19,22 mm					
52-01-365	-	-	Jgo.	5	
14 Piezas: 6 a 15, 17,19,22,24 mm					
52-01-370	-	-	Jgo.	3	

LLAVE CRUZ

Acero carbono forjado

MEDIDAS PUNTAS
17, 19, 21 y 23 mm



CODIGO	REF.	MEDIDA/TIPO	UN.		PRECIO + IVA
52-01-090	-	14"	Pza.	20	

LLAVE CRUZ REFORZADA

Acero carbono forjado

MEDIDAS PUNTAS
17, 19 y 21mm x 1/2"



CODIGO	REF.	MEDIDA/TIPO	UN.		PRECIO + IVA
52-01-092	-	14"	Pza.	15	

ACEITERA

Con flexible



CODIGO	REF.	MEDIDA/TIPO	UN.		PRECIO + IVA
52-01-655	-	285 cc	Pza.	10	

Flexible para aceitera

CODIGO	REF.	MEDIDA/TIPO	UN.		PRECIO + IVA
52-01-686	-	-	Pza.	-	

ENGRASADORA A PRESIÓN

Con palanca y tubo flexible



CODIGO	REF.	MEDIDA/TIPO	UN.		PRECIO + IVA
52-01-590	-	420 g	Pza.	-	

LLAVE SACA FILTRO PESADO



CODIGO	REF.	MEDIDA/TIPO	UN.		PRECIO + IVA
52-01-610	-	-	Pza.	12	

EXTRACTOR DE 3 PATAS



CODIGO	REF.	MEDIDA/TIPO	UN.		PRECIO + IVA
52-01-010	-	3"	Pza.	-	
52-01-011	-	4"	Pza.	-	
52-01-012	-	6"	Pza.	-	

PRENSA "G" PESADA

Soporta gran fuerza de apriete

En caja litografiada



CODIGO	REF.	MEDIDA/TIPO	UN.		PRECIO + IVA
52-02-207	-	3"	Pza.	20	

TORNILLO DE BANCO "BABY", FIJO

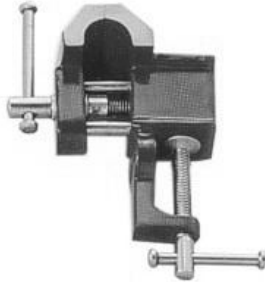

CODIGO	REF.	MEDIDA/TIPO	UN.		PRECIO + IVA
52-01-452	-	2"	Pza.	20	
52-01-454	-	2.1/2"	Pza.	20	
52-01-456	-	3"	Pza.	20	

MARTILLO SOLDADOR

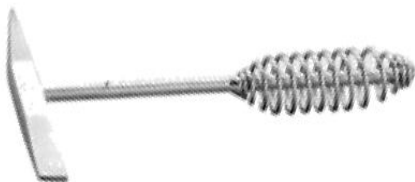

CODIGO	REF.	MEDIDA/TIPO	UN.		PRECIO + IVA
52-01-020	-	-	Pza.	10	

LLAVE STILLSON



CODIGO	REF.	MEDIDA/TIPO	UN.		PRECIO + IVA
52-01-500	-	8"	Pza.	15	
52-01-505	-	10"	Pza.	10	
52-01-510	-	12"	Pza.	10	
52-01-515	-	14"	Pza.	6	
52-01-520	-	18"	Pza.	4	

CINCELES Y PUNTOS PARA CONCRETO

Con protector PVC



CODIGO	REF.	MEDIDA/TIPO	UN.		PRECIO + IVA
--------	------	-------------	-----	--	--------------

Cinzel

52-03-150	-	8"	Pza.	10	
52-03-155	-	10"	Pza.	10	
52-03-160	-	12"	Pza.	6	

Punto

52-03-180	-	8"	Pza.	10	
52-03-185	-	10"	Pza.	10	
52-03-190	-	12"	Pza.	6	

PRECIOS REBAJADOS

ARTÍCULOS DE CUERO

Porta herramientas
Doble Bolsillo



CODIGO	REF.	MEDIDA/TIPO	UN.		PRECIO + IVA
52-20-010	-	-	Pza.	50	

Porta herramientas
Un Bolsillo



CODIGO	REF.	MEDIDA/TIPO	UN.		PRECIO + IVA
52-20-012	-	-	Pza.	50	

Porta martillo fijo



CODIGO	REF.	MEDIDA/TIPO	UN.		PRECIO + IVA
52-20-026	-	-	Pza.	100	

BANDEJAS ACERO INOXIDABLE Redonda



CODIGO	REF.	MEDIDA/TIPO	UN.		PRECIO + IVA
52-07-258	-	30 cm	Pza.	30	
52-07-259	-	35 cm	Pza.	30	
52-07-260	-	40 cm	Pza.	20	

BROCHAS ECOSA

Excelente brocha de cerda natural, vulcanizada y mango de madera pulido

Con extremo verde y orificio para colgar (a excepción de las medidas 1/2" y 3/4").
Las brochas ECOSA vienen en cajas litografiadas con el logotipo, descripción del producto, medida y código

CODIGO	MEDIDA/TIPO	UN.		MIN.	PRECIO + IVA
39-04-010	1/2"	Pza.	1200	12	
39-04-012	3/4"	Pza.	1200	12	
39-04-014	1"	Pza.	600	12	
39-04-016	1.1/2"	Pza.	600	12	
39-04-018	2"	Pza.	480	12	
39-04-020	2.1/2"	Pza.	360	12	
39-04-022	3"	Pza.	240	12	
39-04-024	4"	Pza.	192	12	
39-04-026	5"	Pza.	48	12	



BROCHAS PERFECTA

Especialmente diseñada para el profesional exigente

Mango de madera anatómico pulido y barnizado. Virola metálica con estañado doble para evitar la oxidación. Vulcanizado epóxico

CODIGO	MEDIDA/TIPO	UN.		MIN.	PRECIO + IVA
39-04-060	3/4"	Pza.	480	12	
39-04-062	1"	Pza.	600	12	
39-04-064	1.1/2"	Pza.	600	12	
39-04-066	2"	Pza.	300	12	
39-04-068	2.1/2"	Pza.	300	12	
39-04-070	3"	Pza.	240	12	
39-04-072	4"	Pza.	240	12	



BROCHAS 637 PREMIUM

Envasada individualmente en estuche plástico, con sistema blister

Excelente brocha de cerda negra natural, vulcanizada y con mango plástico de insuperable calidad, con extremo dorado y orificio para colgar

CODIGO	MEDIDA/TIPO	UN.		MIN.	PRECIO + IVA
39-04-040	1"	Pza.	600	12	
39-04-042	1.1/2"	Pza.	480	12	
39-04-044	2"	Pza.	300	12	
39-04-046	2.1/2"	Pza.	240	12	
39-04-048	3"	Pza.	240	12	
39-04-050	4"	Pza.	120	12	



EXTRACTO DE CAOBA

Procedencia: Alemania

Preparación: Mezclar la cantidad necesaria con un poco de agua fría y revolver hasta obtener una masa homogénea. Agregar agua caliente a punto de hervir y disolver la masa revolviendo constantemente. Dejar enfriar y está listo para su uso

CODIGO	MEDIDA	EMPAQUE	CANTIDAD		PRECIO + IVA
45-09-101	-	Bolsa	1 kg	-	
90-09-050	-	Bolsa	50 g	-	



EXTRACTO DE NOGAL

Procedencia: Alemania

Preparación: Se diluye con agua fría o tibia

CODIGO	MEDIDA	EMPAQUE	CANTIDAD		PRECIO + IVA
90-09-060	-	Saco	25 kg	-	
70-09-105	-	Bolsa	1 kg	-	
90-09-100	-	Bolsa	100 g	-	



PISTOLA PINTAR BAJA PRESIÓN

Presión 20 – 40 PSI

ESPECIFICACIONES

Depósito de aluminio 1 litro

Boquilla 1,3 mm



CODIGO REF. MEDIDA/TIPO UN.  PRECIO + IVA

Pistola

54-04-042	MD - 472	1/4"	Pza.	10	
-----------	----------	------	------	----	--

Juego de refacción

54-04-222	-	-	Pza.	10	
-----------	---	---	------	----	--

Empaquetadura

54-04-223	-	-	Pza.	10	
-----------	---	---	------	----	--

PISTOLA PINTAR ALTA PRESIÓN

Presión 50 – 80 PSI

ESPECIFICACIONES

Depósito de aluminio 1 litro

Boquilla 2,0 mm

Consumo de aire 7-13 cfm
(pies cúbicos por minuto)



CODIGO REF. MEDIDA/TIPO UN.  PRECIO + IVA

Pistola

54-04-016	PQ-2U	1/4"	Pza.	10	
-----------	-------	------	------	----	--

Empaquetadura

54-04-217	-	-	Pza.	10	
-----------	---	---	------	----	--

PISTOLA PINTAR ALTA PRESIÓN, para máxima exigencia

Presión 50 – 80 PSI

Recubrimiento exterior de alta calidad y durabilidad. Diseñada para las más altas exigencias. Debido a su boquilla de atomización de menor grado (1,7mm en vez de 2,0mm) permite la obtención de una pintura homogénea, con excelentes resultados

ESPECIFICACIONES

Depósito de aluminio 1 litro

Boquilla 1,7 mm

Consumo de aire 7-12 cfm
(pies cúbicos por minuto)



CODIGO REF. MEDIDA/TIPO UN.  PRECIO + IVA

Pistola

54-04-010	4001S	1/4"	Pza.	-	
-----------	-------	------	------	---	--

Juego de refacción

54-04-210	-	-	Pza.	-	
-----------	---	---	------	---	--

(1) Tapa de ajuste

54-04-238	-	-	Pza.	-	
-----------	---	---	------	---	--

(2) Filtro

54-04-241	-	-	Pza.	-	
-----------	---	---	------	---	--

Empaquetadura

54-04-211	-	-	Pza.	-	
-----------	---	---	------	---	--

PISTOLA PINTAR GRAVEDAD ALTA PRESIÓN “MINI”

Presión 50 - 80 PSI

Presentación: caja litografiada con instructivo en su interior

Incluye llave de ajustes



ESPECIFICACIONES

Depósito de Aluminio 200 ml
Boquilla: 0,5 mm

CODIGO	REF.	MEDIDA/TIPO	UN.	PRECIO + IVA
54-04-046	F-2	1/4"	Pza. 40	

PISTOLA PINTAR GRAVEDAD ALTA PRESIÓN

Presión 50 - 80 PSI

Presentación: caja litografiada con instructivo en su interior

Incluye llave de ajustes y cepillo de limpieza



ESPECIFICACIONES

Depósito de aluminio de 400 ml
Boquilla 1.5 mm

CODIGO	REF.	MEDIDA/TIPO	UN.	PRECIO + IVA
54-04-048	F-75G	1/4"	Pza. 20	

PISTOLA PINTAR GRAVEDAD ALTA PRESIÓN

Presión 50 - 80 PSI

Presentación: caja litografiada con instructivo en su interior

ESPECIFICACIONES

Depósito plástico de 600 ml
Boquilla 1.5 mm



CODIGO	REF.	MEDIDA/TIPO	UN.	PRECIO + IVA
54-04-053	S-990G	1/4"	Pza. 20	

PISTOLA PINTAR GRAVEDAD BAJA PRESIÓN

Línea de alta eficiencia HVLP (alto volumen a baja presión)

Presentación: caja litografiada con instructivo en su interior

Incluye llaves de ajuste, filtro y cepillo de limpieza



ESPECIFICACIONES

Presión 43 PSI
Depósito plástico de 600 ml
Boquilla 1.4 mm

CODIGO	REF.	MEDIDA/TIPO	UN.	PRECIO + IVA
--------	------	-------------	-----	--------------

Pistola

54-04-050	H-827	1/4"	Pza. 10	
-----------	-------	------	---------	--

Depósito plástico (vaso)

54-04-244	-	-	Pza. 10	
-----------	---	---	---------	--

PISTOLA GRAVILLAR GRAVEDAD

Presión 50 - 80 PSI

Incluye llave paso de aire y acople rápido

ESPECIFICACIONES

Depósito plástico de 6000 ml
Boquillas 4 - 6 - 8 mm



CODIGO	REF.	MEDIDA/TIPO	UN.	PRECIO + IVA
54-04-056	FR-301	1/4"	Pza. 6	

PISTOLA ALTA PRESIÓN

Con regulador de presión

ESPECIFICACIONES

Estanque de 8 litros
Mangueras de aire y producto, largo 4 m



CODIGO	REF.	MEDIDA/TIPO	UN.	PRECIO + IVA
54-04-060	PT-8	1/4"	Pza. 2	

PISTOLA PULVERIZADORA

Presión 90 - 150 PSI

Capacidad recipiente 900 cc



CODIGO	REF.	MEDIDA/TIPO	UN.	PRECIO + IVA
54-04-063	DO-10	1/4"	Pza. 2 / 20	

FILTRO DE AIRE

Con regulador de presión

ESPECIFICACIONES

Presión 50 - 80 PSI
Rango de temperatura 5 - 60 °C



CODIGO	REF.	MEDIDA/TIPO	UN.	PRECIO + IVA
54-04-164	AFR - 80	1/4"	Pza. 20	

FILTRO REGULADOR / LUBRICADOR

Filtro de aire, regulador de presión y lubricador

ESPECIFICACIONES

Presión 50 - 80 PSI
Rango de temperatura 5 - 60 °C



CODIGO	REF.	MEDIDA/TIPO	UN.	PRECIO + IVA
54-04-166	AFRL 80	1/4"	Pza. 20	

PISTOLA PARA SOPLETEAR

Set 3 Piezas

Pistola de golpe de aire
Manguera espiral 3 m Aprox.
Adaptador para conexión directa al camión



CODIGO	REF.	MEDIDA/TIPO	UN.	PRECIO + IVA
54-04-072	DG-10A	1/4"	Pza. 40	

RODILLO CHIPORRO SINTÉTICO ECOSA

Para todo tipo de superficies

Gran rendimiento

Recomendado para todo tipo de pinturas

Con apoya dedo para mejor manejo

Largo del pelo 6 mm / corto

CODIGO	REF.	ANCHO	UN.		PRECIO + IVA
29-04-120	9900020041209	12 cm	Pza.	-	
29-04-122	9900020041223	18 cm	Pza.	-	
29-04-124	9900020041247	23 cm	Pza.	-	

Largo del pelo 18 mm / mediano

CODIGO	REF.	ANCHO	UN.		PRECIO + IVA
29-04-130	9900020041308	12 cm	Pza.	-	
29-04-132	9900020041322	18 cm	Pza.	-	
29-04-134	9900020041346	23 cm	Pza.	-	

Largo del pelo 25 mm / largo

CODIGO	REF.	ANCHO	UN.		PRECIO + IVA
29-04-140	9900020041407	12 cm	Pza.	-	
29-04-142	9900020041421	18 cm	Pza.	-	
29-04-144	9900020041445	23 cm	Pza.	-	



RODILLO ESPONJA DE POLYESTER ECOSA

Polyester de alta densidad

Para todo tipo de pinturas

Acabado liso y parejo

Con apoya dedo para mejor manejo

CODIGO	REF.	ANCHO	UN.		PRECIO + IVA
29-04-110	9900020041100	5 cm	Pza.	-	
29-04-112	9900020041124	9 cm	Pza.	-	
29-04-114	9900020041148	12 cm	Pza.	-	
29-04-116	9900020041162	18 cm	Pza.	-	



BANDEJA PLÁSTICA PARA RODILLO

CODIGO	REF.	MEDIDA/TIPO	UN.		PRECIO + IVA
29-04-310	9900020043104	9"	Pza.	-	



CINTA DE ENMASCARAR 30 M

CODIGO	REF.	MEDIDA/TIPO	UN.		PRECIO + IVA
29-04-202	9900029042023	18 mm	Pza.	192	
29-04-204	9900029042047	24 mm	Pza.	96	
29-04-206	9900029042061	36 mm	Pza.	96	
29-04-208	9900029042085	48 mm	Pza.	72	



CINTA DE ENMASCARAR 40 M

Venta mínima: paquetes de 6 unidades

CODIGO	REF.	MEDIDA/TIPO	UN.		PRECIO + IVA
29-04-212	9900020042121	18 mm	Pza.	144 un	



CONECTORES DE BRONCE PARA MANGUERA

Conector



CODIGO	REF.	MEDIDA/TIPO	UN.		PRECIO + IVA
14-11-236	1207	1/2"	Pza.	-	

Conexión HI



CODIGO	REF.	MEDIDA/TIPO	UN.		PRECIO + IVA
14-11-231	1202	1/2" - 3/4"	Pza.	-	

Conector



CODIGO	REF.	MEDIDA/TIPO	UN.		PRECIO + IVA
14-11-241	1216	3/4"	Pza.	-	

Conexión HI



CODIGO	REF.	MEDIDA/TIPO	UN.		PRECIO + IVA
14-11-234	1210	1"	Pza.	-	

Conexión HE

Acople para pitón y aspersor "Truper"



CODIGO	REF.	MEDIDA/TIPO	UN.		PRECIO + IVA
14-11-227	1201	3/4"	Pza.	-	

CONECTORES PLÁSTICOS PARA MANGUERA

Conexión HI



CODIGO	REF.	MEDIDA/TIPO	UN.		PRECIO + IVA
14-11-230	1015	1/2" - 3/4"	Pza.	-	

Conector con stop

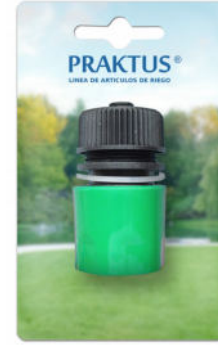

CODIGO	REF.	MEDIDA/TIPO	UN.		PRECIO + IVA
14-11-235	1001	1/2"	Pza.	-	
14-11-240	1018	3/4"	Pza.	-	

Conexión HI



CODIGO	REF.	MEDIDA/TIPO	UN.		PRECIO + IVA
14-11-233	1016	1"	Pza.	-	

Conector sin stop

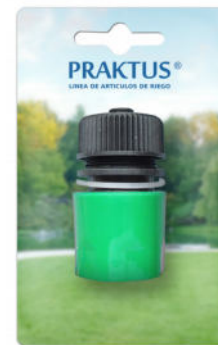

CODIGO	REF.	MEDIDA/TIPO	UN.		PRECIO + IVA
14-11-237	1002	1/2"	Pza.	-	

Reparador de manguera



CODIGO	REF.	MEDIDA/TIPO	UN.		PRECIO + IVA
14-11-246	1013	1/2"	Pza.	-	
14-11-243	1020	3/4"	Pza.	-	

"Y" con válvulas



CODIGO	REF.	MEDIDA/TIPO	UN.		PRECIO + IVA
14-11-250	3810	1/2" - 3/4"	Pza.	-	

Pitón



CODIGO	REF.	MEDIDA/TIPO	UN.		PRECIO + IVA
14-11-155	5109	1/2"	Pza.	-	

Set Pitón y conectores para manguera



CODIGO	REF.	MEDIDA/TIPO	UN.		PRECIO + IVA
14-11-164	6108	1/2" - 3/4"	Pza.	-	

Pitón tipo Pistola

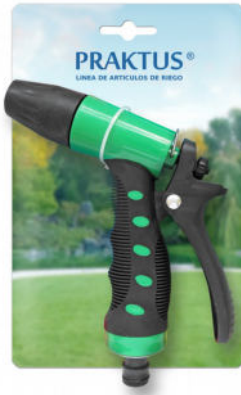

CODIGO	REF.	MEDIDA/TIPO	UN.		PRECIO + IVA
14-11-158	5108	1/2"	Pza.	-	

Aspersor de impacto plástico



CODIGO	REF.	MEDIDA/TIPO	UN.		PRECIO + IVA
14-11-178	2101	3/4"	Pza.	-	

Pitón tipo Pistola, 5 funciones



CODIGO	REF.	MEDIDA/TIPO	UN.		PRECIO + IVA
14-11-161	5105	1/2"	Pza.	-	

Aspersor "rotativo" plástico, 3 brazos c/estaca



CODIGO	REF.	MEDIDA/TIPO	UN.		PRECIO + IVA
14-11-185	2502	1/2"	Pza.	-	

CONTROLADORES ELECTRÓNICOS PARA BOMBA DE AGUA

Para automatizar el funcionamiento de una bomba, según la apertura o cierre de llaves u otros consumos.

Mantiene la presión constante e impide el funcionamiento de la bomba en seco.

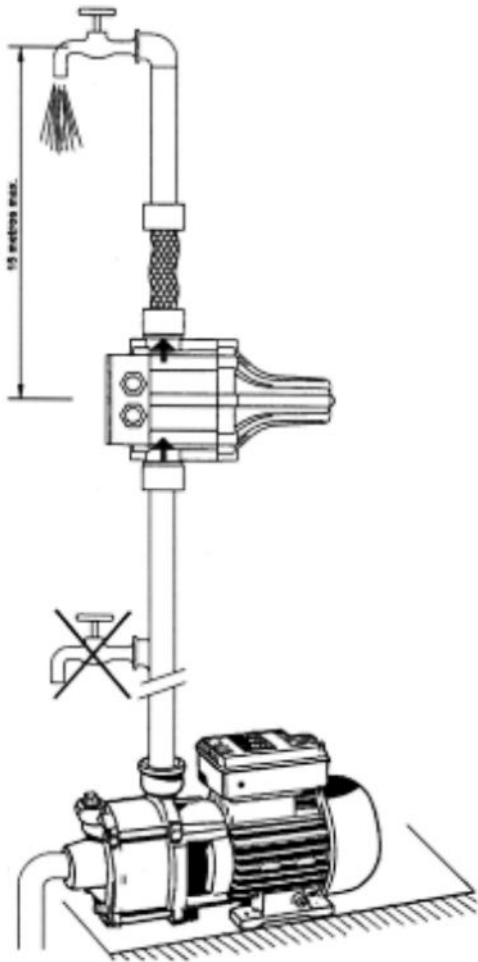

Modelo PS01

ESPECIFICACIONES

Tensión nominal: 220V / 240V

Corriente máxima: 10A

Frecuencia: 50 / 60Hz

Rosca de conexión: 1"

Presión máxima de trabajo: 10 bar

Protección: IP65

Temperatura máxima de funcionamiento: 60 °C



CODIGO	REF.	MEDIDA/TIPO	UN.	PRECIO + IVA
07-06-010	PS01	1"	Pza.	-

Modelo PS01D

Incluye medidor de presión

ESPECIFICACIONES

Tensión nominal: 220V / 240V

Corriente máxima: 30A

Frecuencia: 50 / 60Hz

Rosca de conexión: 1.1/2"

Presión máxima de trabajo: 10 bar

Protección: IP65

Temperatura máxima de funcionamiento: 60°C



CODIGO	REF.	MEDIDA/TIPO	UN.	PRECIO + IVA
07-06-015	PS01D	1.1/2"	Pza.	-

VÁLVULA DE LLENADO AUTOMÁTICO DE ESTANQUE

Tipo horizontal/interior

Corta el flujo instantáneamente al alcanzar el nivel de llenado (no gradual)

Reemplaza a las válvulas con flotador

Para todo tipo de estanques de agua

INCLUYE:

Tuerca plástica

Codo 90°

Filtro de agua

Cinta PTFE



CODIGO	REF.	MEDIDA/TIPO	UN.		PRECIO + IVA
09-06-100	-	1/2"	Pza.	-	
09-06-104	-	3/4"	Pza.	-	
09-06-108	-	1"	Pza.	-	

INTERRUPTOR DE NIVEL

Tipo flotador

ESPECIFICACIONES

Tensión nominal: 220V / 240V

Corriente máxima: 16A

Frecuencia: 50 / 60Hz

Protección: IP68

Temperatura máxima de funcionamiento: 55°C

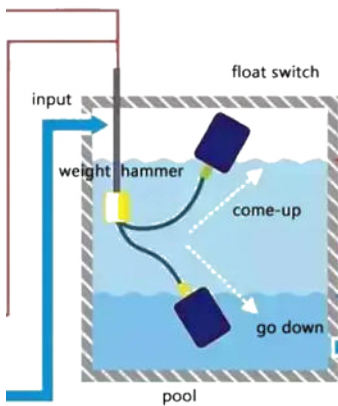

CODIGO	REF.	MEDIDA/TIPO	UN.		PRECIO + IVA
07-06-020	FS03-3	3 m	Pza.	-	
07-06-022	FS03-5	5 m	Pza.	-	

FILTRO DE RIEGO CON MALLA



CODIGO	REF.	MEDIDA/TIPO	UN.		PRECIO + IVA
09-06-200	FSY025	3/4"	Pza.	-	
09-06-202	FSY032	1"	Pza.	-	
09-06-204	1740S120	1.1/4"	Pza.	-	
09-06-206	1750S120	1.1/2"	Pza.	-	
09-06-208	SY02120	2"	Pza.	-	

FITTINGS PARA CAÑERÍA PLANZA

En bolsa plástica, cantidad según medida



GOTERO AUTOCOMPENSADO



CODIGO	REF.	MEDIDA/TIPO	UN.	MIN.	PRECIO + IVA
31-11-012	-	2 L	Pza.	500	
31-11-014	-	4 L	Pza.	500	
31-11-016	-	6 L	Pza.	500	

CODO POLIETILENO



CODIGO	REF.	MEDIDA/TIPO	UN.	MIN.	PRECIO + IVA
31-11-080	-	1/2"	Pza.	100	
31-11-082	-	3/4"	Pza.	50	
31-11-084	-	1"	Pza.	50	

COPLA DOBLE POLIETILENO



CODIGO	REF.	MEDIDA/TIPO	UN.	MIN.	PRECIO + IVA
31-11-030	-	1/2"	Pza.	200	
31-11-032	-	3/4"	Pza.	50	
31-11-034	-	1"	Pza.	50	

TEE POLIETILENO



CODIGO	REF.	MEDIDA/TIPO	UN.	MIN.	PRECIO + IVA
31-11-070	-	1/2"	Pza.	100	
31-11-072	-	3/4"	Pza.	25	
31-11-074	-	1"	Pza.	50	

TERMINAL HE POLIETILENO



CODIGO	REF.	MEDIDA/TIPO	UN.	MIN.	PRECIO + IVA
31-11-050	-	1/2"	Pza.	200	
31-11-052	-	3/4"	Pza.	50	
31-11-054	-	1"	Pza.	50	

TERMINAL REDUCCION HE POLIETILENO



CODIGO	REF.	MEDIDA/TIPO	UN.	MIN.	PRECIO + IVA
31-11-056	-	1" - 3/4"	Pza.	50	

TERMINAL HI POLIETILENO



CODIGO	REF.	MEDIDA/TIPO	UN.	MIN.	PRECIO + IVA
31-11-060	-	1/2"	Pza.	100	
31-11-062	-	3/4"	Pza.	50	

TEE REDUCCION POLIETILENO



CODIGO	REF.	MEDIDA/TIPO	UN.	MIN.	PRECIO + IVA
31-11-076	-	3/4" - 1/2"	Pza.	100	

TERMINAL POLIETILENO



CODIGO	REF.	MEDIDA/TIPO	UN.	MIN.	PRECIO + IVA
31-11-100	-	1/2"	Pza.	100	
31-11-102	-	3/4"	Pza.	100	

ASPERSOR MICROJET



CODIGO	REF.	MEDIDA/TIPO	UN.	MIN.	PRECIO + IVA
31-11-120	-	90° - 60 l/h	Pza.	100	
31-11-122	-	180° - 60 l/h	Pza.	100	
31-11-124	-	360° - 60 l/h	Pza.	100	

LLAVE DE BOLA PARA JARDÍN



CODIGO	MEDIDA/TIPO	UN.		MIN.	PRECIO + IVA
33-06-062	1/2" x 3/4"	Pza.	-	-	
33-06-064	3/4" x 1"	Pza.	-	-	

LLAVE DE BOLA DE PASO, PASO TOTAL

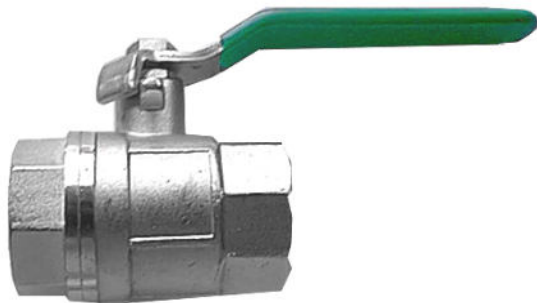

CODIGO	MEDIDA/TIPO	UN.		MIN.	PRECIO + IVA
33-06-070	1/2"	Pza.	-	-	
33-06-072	3/4"	Pza.	-	-	
33-06-074	1"	Pza.	-	-	
33-06-075	1.1/4"	Pza.	-	-	
33-06-076	1.1/2"	Pza.	-	-	
33-06-078	2"	Pza.	-	-	

Revise también

BROCHAS ECOSA

Excelente brocha de cerda natural, vulcanizada y con mango de madera pulido

Con extremo verde y orificio para colgar (a excepción de las medidas 1/2" y 3/4"). Las brochas ECOSA vienen en cajas litografiadas con el logotipo, descripción del producto, medida y código

Venta solo en docenas



CODIGO	MEDIDA/TIPO	UN.		MIN.	PRECIO + IVA
39-04-010	1/2"	Pza.	1200	12	
39-04-012	3/4"	Pza.	1200	12	
39-04-014	1"	Pza.	1200	12	
39-04-016	1.1/2"	Pza.	600	12	
39-04-018	2"	Pza.	480	12	
39-04-020	2.1/2"	Pza.	360	12	
39-04-022	3"	Pza.	240	12	
39-04-024	4"	Pza.	192	12	
39-04-026	5"	Pza.	48	12	

MANGUERA JARDÍN CON ACCESORIOS

Incluye: pitón y conectores



CODIGO	REF.	MEDIDA/TIPO	UN.		PRECIO + IVA
79-11-010	-	1/2" x 15 m	Rollo	6	

CARRETE PORTÁTIL PARA MANGUERAS

- Fácil montaje sin herramientas
- Resistente al oxido y a la corrosión
- Base metálica



CODIGO	REF.	MEDIDA/TIPO	UN.		PRECIO + IVA
14-11-190	-	1/2" - 25 m	Pza.	-	

MANGUERA ESPIRAL RETRÁCTIL

Plástico ABS duradero

- Se expande y retrae con facilidad
- Incluye adaptador 1/2" - 3/4"
- Pistola pulverizadora 7 modos



CODIGO	REF.	MEDIDA/TIPO	UN.		PRECIO + IVA
14-11-200	-	7.5 m	Pza.	-	

SENSOR PARA PUERTA CON SONIDO Y VOZ

Rango sensor: 3-6M (dependiendo de la cantidad de luz)



Voz que dice "Hello, Welcome" en 8 lenguas incluyendo español.
Adicionalmente 25 Multi-Melodías.
Usa 3 Pilas "AA" o un transformador externo de DC "4.5V,300mA" (no incluidos)
Presentación: display con instrucciones al reverso.



CODIGO	REF.	MEDIDA/TIPO	UN.		PRECIO + IVA
75-05-005	RD-638	10,5 x 6 cm	Pza.	-	

INTERCOMUNICADOR

100 m

Buena comunicación, libre de interferencias.
Para instalaciones con una distancia máxima de 100 m (no incluye cable)
Opera con 3 baterías alcalinas AA para cada aparato (no incluidas)
Presentación: caja litografiada con instrucciones al reverso.



CODIGO	REF.	MEDIDA/TIPO	UN.		PRECIO + IVA
10-05-030	QH-892	9 x 20 cm	Pza.	10	

TIMBRE INALÁMBRICO

Alcance hasta 100 m al aire libre

Fácil instalación.
24 sonidos distintos "seleccionables".
Incluye batería para el pulsador (emisor)
El timbre (receptor) requiere 3 baterías alcalinas AA "no incluidas".
Ideal para casas, oficinas, hoteles, etc.
que no cuenten con instalación alámbrica.
Presentación: display con instrucciones al reverso.



CODIGO	REF.	MEDIDA/TIPO	UN.		PRECIO + IVA
10-05-010	QH-918	8 x 10 cm / 3 x 7 cm	Pza.	30	

Escaleras



ESCALERA TIPO ANDAMIO 150 KG
6 peldaños



CODIGO	REF.	MEDIDA/TIPO	UN.		PRECIO + IVA
82-20-040	-	158 x 158 cm	Pza.	-	

MARTILLO MECÁNICO
Modelo 305



CODIGO	REF.	MEDIDA/TIPO	UN.		PRECIO + IVA
38-01-115	-	500 g	Pza.	-	
38-01-120	-	700 g	Pza.	-	
38-01-125	-	1.000 g	Pza.	-	
38-01-127	-	1.200 g	Pza.	-	

Pernos

PERNO COCINA ZINCADO
Cabeza combinada



CODIGO	REF.	MEDIDA/TIPO	UN.		PRECIO + IVA
67-08-127	-	5/32 x 5/8"	Cien	-	
67-08-128	-	5/32 x 3/4"	Cien	-	
67-08-131	-	5/32 x 1.1/4"	Cien	-	
67-08-171	-	1/4 x 3/4"	Cien	-	

NIVEL
3 aguas



CODIGO	REF.	MEDIDA/TIPO	UN.		PRECIO + IVA
38-03-254	-	30"	Pza.	-	



ABRAZADERA DE ACERO, "TITÁN"
En bolsas de 50 unidades



CODIGO	REF.	MEDIDA/TIPO	UN.	MIN	PRECIO + IVA
81-20-144	-	12,7-23,1 mm	Pza.	50	

FORMÓN
Mango madera



CODIGO	REF.	MEDIDA/TIPO	UN.		PRECIO + IVA
38-02-240	-	1"	Pza.	-	

LUZ TRASERA ROJA PARA BICICLETA

3 LED

Alta potencia de iluminación
3 modalidades: luz fija y 2 intermitentes
Opera con 2 pilas AAA (no incluidas)
Envase blister con instrucciones al reverso



CODIGO	REF.	MEDIDA/TIPO	UN.		PRECIO + IVA
73-20-027	-	4 x 6,5 cm	Pza.	-	

QUEMADOR N° 4

Curvo, llama larga



CODIGO	REF.	MEDIDA/TIPO	UN.		PRECIO + IVA
65-06-155	-	Ø 35 mm	Pza.	-	

ANILLO DE GOMA PARA AGUJA



CODIGO	REF.	MEDIDA/TIPO	UN.		PRECIO + IVA
65-10-230	-	-	Pza.	20	

HOJA HSS PARA MÁQUINA

10 dpp



CODIGO	REF.	MEDIDA/TIPO	UN.		PRECIO + IVA
63-01-190	-	300 x 25 x 1,25	Pza.	-	
63-01-200	-	350 x 25 x 1,50	Pza.	-	

BOTÓN PLÁSTICO PARA ARTEFACTOS (PERILLA NEGRA)



CODIGO	REF.	MEDIDA/TIPO	UN.		PRECIO + IVA
65-10-225	-	-	Pza.	25	

HOJA SIERRA PARA ARCO JUNIOR

Acero carbono de gran resistencia



Dientes correctamente endurecidos y templados para una mayor vida útil



CODIGO	REF.	MEDIDA/TIPO	UN.		PRECIO + IVA
48-01-060	-	6" - 14 dtes.	Pza.	10	
48-01-062	-	6" - 24 dtes.	Pza.	10	
48-01-064	-	6" - 32 dtes.	Pza.	10	

REJILLA PARA QUEMADOR INFRARROJO



CODIGO	REF.	MEDIDA/TIPO	UN.		PRECIO + IVA
65-10-229	-	-	Pza.	-	

VÁLVULAS DE BOLA PVC

Compacta, con hilo HI



CODIGO	REF.	MEDIDA/TIPO	UN.		PRECIO + IVA
71-11-014	-	1"	Pza.	-	
71-11-016	-	1.1/4"	Pza.	-	

Con hilo, 1 Unión Americana



CODIGO	REF.	MEDIDA/TIPO	UN.		PRECIO + IVA
71-11-054	-	1"	Pza.	-	
71-11-056	-	1.1/4"	Pza.	-	
71-11-057	-	1.1/2"	Pza.	-	
71-11-059	-	2"	Pza.	-	

VÁLVULA DE PIE PVC

Con Filtro e hilo



CODIGO	REF.	MEDIDA/TIPO	UN.		PRECIO + IVA
71-11-250	-	3/4"	Pza.	-	

BIDET PARA WC DOS FUNCIONES

Solución económica y práctica para la higiene íntima.

Dos boquillas pulverizadoras.
Ranuras ajustables al tamaño del WC.
Se instala entre el WC y su tapa.
Para agua fría.

Incluye:
Conector plástico tipo T de 1/2".
Manguera de 80 cm.
Instructivo de instalación.



CODIGO	REF.	MEDIDA/TIPO	UN.		PRECIO + IVA
28-06-001	-	-	Pza.	-	